

STORAGE PRODUCTS

DURHAM

Established in 1922

NEW PRODUCTS
p. 6, 14, 15, 16, 18, 19



p. 10-13

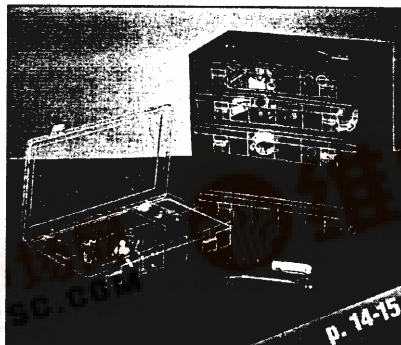

p. 14-15



p. 16-18

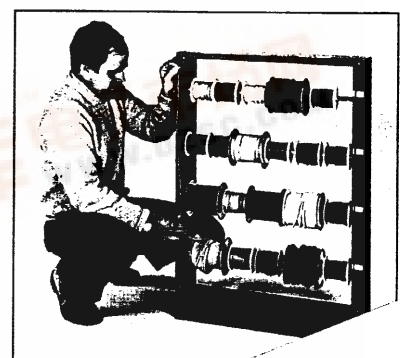
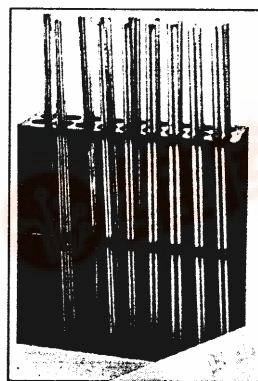

THE DURHAM MANUFACTURING COMPANY
201 Main Street, P.O. Box 230, Durham, Connecticut 06422-0230
TEL: 1-(800)-243-3774 • FAX: 1-(800)-782-5499
IN CT: 1-(203)-349-3427 • FAX: 1-(203)-349-8572

DRAWER CABINETS

Durham Drawer Cabinets have a reputation for quality construction. They are manufactured on automated tooling to provide uniformity. Only prime cold-rolled steel is used, and finishes are rust and acid resistant baked enamel. Vertical supports provide strength, and embossed mounting holes allow the cabinets to be stacked. Drawers have two runners for smooth, easy travel and are prevented from

being accidentally pulled out of the cabinet by a positive stop.

Drawers for all Durham Drawer Cabinets also feature interlocked design, resulting in unequalled strength. They have full width handles for easy opening and drawer sides are slotted on one inch centers to hold dividers. Two high impact plastic dividers, with special snap-in features to hold them in place, are provided with each drawer.

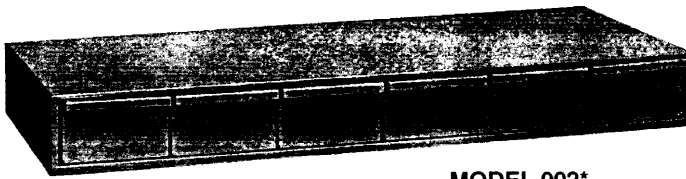

MODEL 002*
(6D)

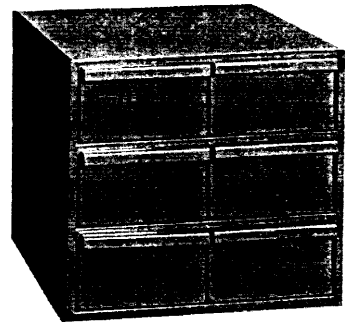

MODEL 001*
(6DV)

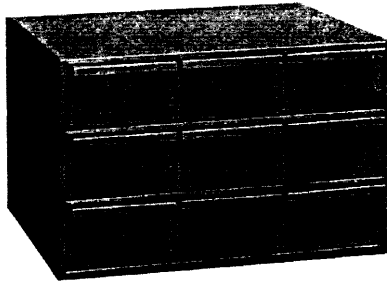

MODEL 004*
(9D)

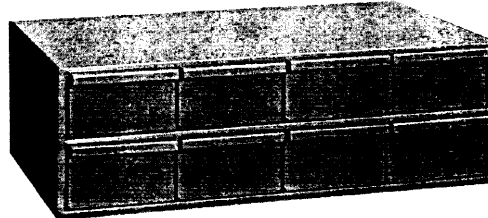

MODEL 003*
(8D)



MODEL 005*
(18D)

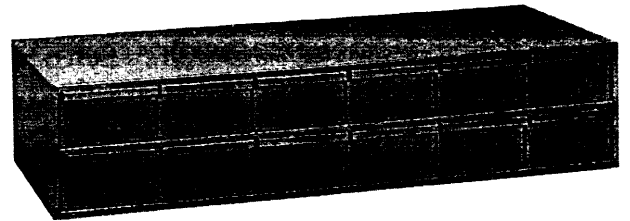

MODEL 013*
(12D)

*Ship via
UPS



SPECIFICATIONS	MODEL									
	002* (6D)	001* (6DV)	003* (8D)	004* (9D)	013* (12D)	005* (18D)	006* (18DV)	007* (24D)	014 (30D)	009 (2417D)
Width, inches	33¾	11¼	22¾	17¼	33¾	33¾	17¼	33¾	33¾	33¾
Height, inches	4	10⅞	7¾	10⅞	7¾	10⅞	21¼	14¾	17¾	10⅞
Depth, inches	11⅞	11⅞	11⅞	11⅞	11⅞	11⅞	11⅞	11⅞	11⅞	17¼
No. of Drawers	6	6	8	9	12	18	18	24	30	24
Drawer Width, inches	5¾	5¾	5¾	5¾	5¾	5¾	5¾	5¾	5¾	5¾
Drawer Height, inches	2¾	2¾	2¾	2¾	2¾	2¾	2¾	2¾	2¾	2
Drawer Depth, inches	11¼	11¼	11¼	11¼	11¼	11¼	11¼	11¼	11¼	17
Drawer Dividers	12	12	16	18	24	36	36	48	60	48
Material	Prime cold rolled steel - interlocking and welded construction									
Color	Gray baked enamel									
Packing per Carton	1	1	1	1	1	1	1	1	1	1
Weight per Carton, lbs	18	17	23	28	24	50	50	62	72	80



Durham Drawer Cabinets are modular and stackable. Unit above consists of **MODELS 002, 005 and 007.**

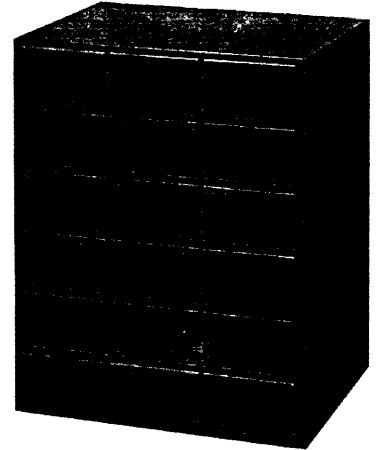

MODEL 006*
(18DV)

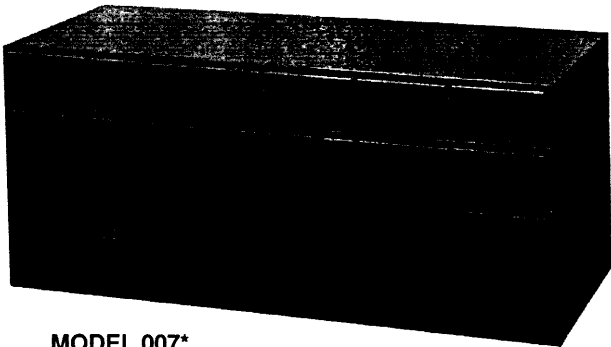

MODEL 007*
(24D)

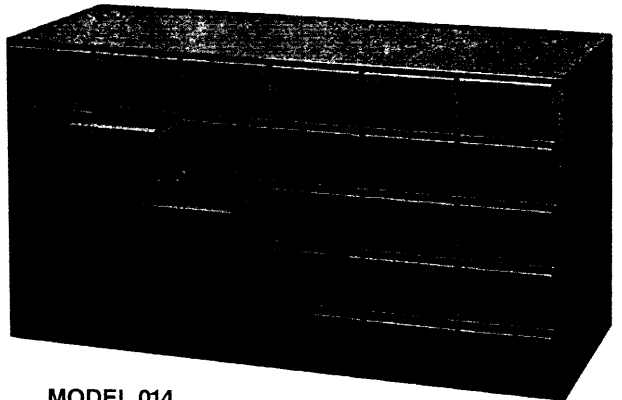

MODEL 014
(30D)

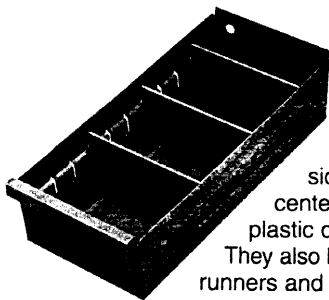

Durham drawers feature sides slotted on one inch centers to hold high impact plastic dividers firmly in place. They also have two easy glide runners and full width handles.

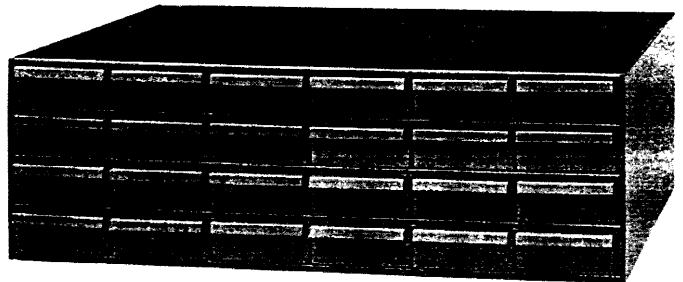

MODEL 009
(2417D)
2" high drawers

SIZE: PART #	SIZE: PART #	SIZE: PART #	SIZE: PART #	SIZE: PART #	SIZE: PART #
SIZE: PART #	SIZE: PART #	SIZE: PART #	SIZE: PART #	SIZE: PART #	SIZE: PART #
SIZE: PART #	SIZE: PART #	SIZE: PART #	SIZE: PART #	SIZE: PART #	SIZE: PART #
SIZE: PART #	SIZE: PART #	SIZE: PART #	SIZE: PART #	SIZE: PART #	SIZE: PART #

Labels for drawers and dividers are available. Black on white pressure sensitive labels are printed 36 per page and sold in 10 page sets.

Durham 11 1/2" Deep Drawer Cabinets are modular for use with 12" Deep Bins. Refer to pages 10 and 11. For Cabinet Bases, refer to page 4.

DRAWER CABINETS (JUMBO DRAWERS)

Featuring the same quality Durham construction as the cabinets on the preceding two pages, Durham Jumbo Drawer Cabinets feature drawers, 3½" high, either 11¼" or 17" deep.

These cabinets are widely used in industrial and commercial applications for the storage of large quantities of fasteners, fittings, tools, and components. Each drawer comes with two high impact plastic dividers.

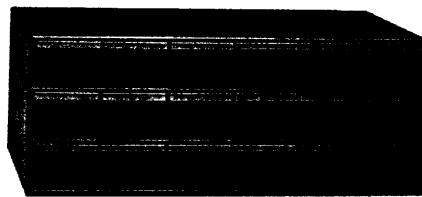

MODEL 030*
(18DR11)

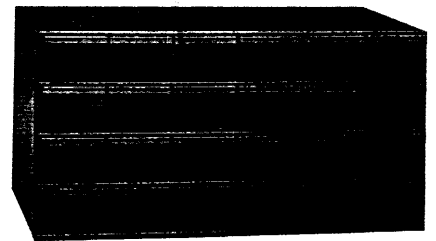

MODEL 031
(24DR11)

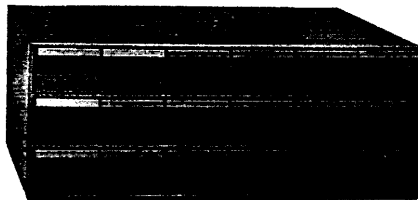

MODEL 032
(18DR17)

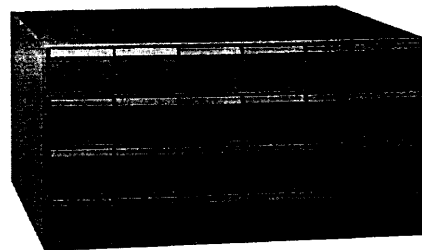

MODEL 033
(24DR17)

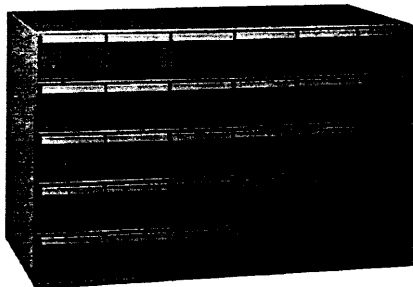

MODEL 034
(30DR11)

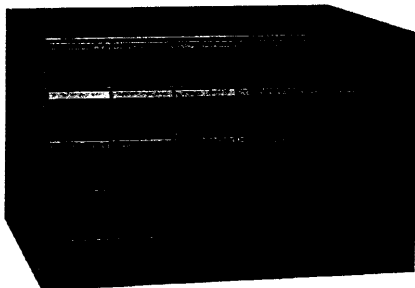

MODEL 035
(30DR17)

Drawer Cabinet Bases

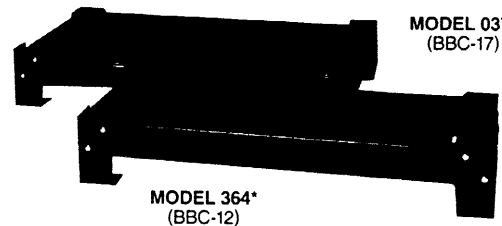

MODEL 037*
(BBC-17)

MODEL 364*
(BBC-12)

Sturdy, all-steel bases are available for the cabinets listed below, shipped unassembled, fasteners provided.

Model	H"xW"xD"	Weight (lbs.)	Use with Cabinet Models
364	5¼"x34½"x12¼"	13	002, 013, 005, 007, 014, 030, 031, 034
037	5¼"x34½"x17½"	17	009, 032, 033, 035

*Ship via
UPS



Durham 11¼" Deep Drawer Cabinets are modular for use with 12" Deep Bins. Refer to pages 10 and 11.

SPECIFICATIONS	MODEL					
	030* (18DR11)	032 (18DR17)	031 (24DR11)	033 (24DR17)	034 (30DR11)	035 (30DR17)
Width, inches	33¾	33¾	33¾	33¾	33¾	33¾
Height, inches	12½	12½	17	17	21½	21½
Depth, inches	11¾	17¼	11¾	17¼	11¾	17¼
No. of Drawers	18	18	24	24	30	30
Drawer Width, inches	5¾	5¾	5¾	5¾	5¾	5¾
Drawer Height, inches	3½	3½	3½	3½	3½	3½
Drawer Depth, inches	11¼	17	11¼	17	11¼	17
Drawer Dividers	36	36	48	48	60	60
Material	Prime cold rolled steel - interlocking and welded construction					
Color	Gray baked enamel					
Packing per Carton	1	1	1	1	1	1

DRAWER CABINET SYSTEMS

These all steel Drawer Cabinet Systems come complete with their own rugged bases. They are manufactured on automated tooling to provide uniformity. Only prime cold rolled steel is used, and they are finished in rust and acid resistant baked enamel. Drawers feature a special interlocking design resulting in superior strength. Each drawer comes

with two high impact plastic dividers. They also include full width handles, embossed runners for smooth, easy opening, and positive stops to prevent spilling. Units having 96, 72, or 48 drawers are available, or custom designed systems can be made using cabinets and bases on pages 2, 3, and 4.

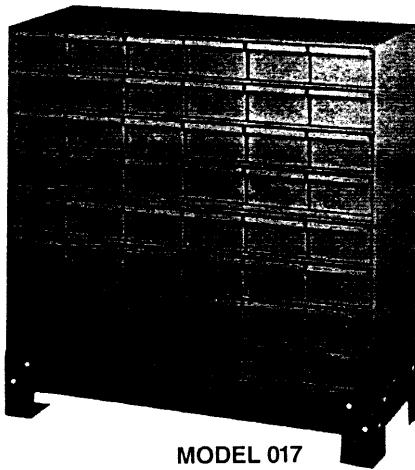

MODEL 017
(48D)

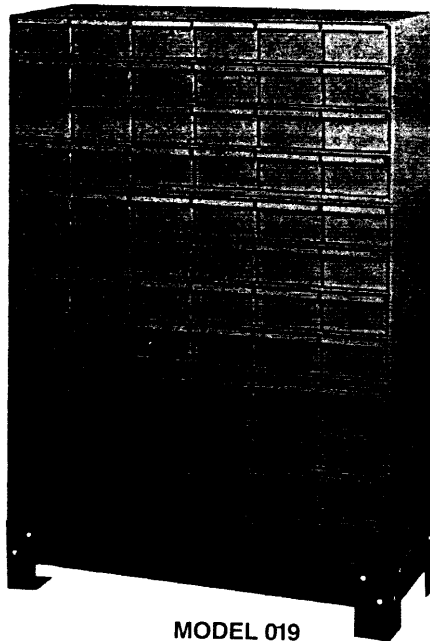

MODEL 019
(72D)

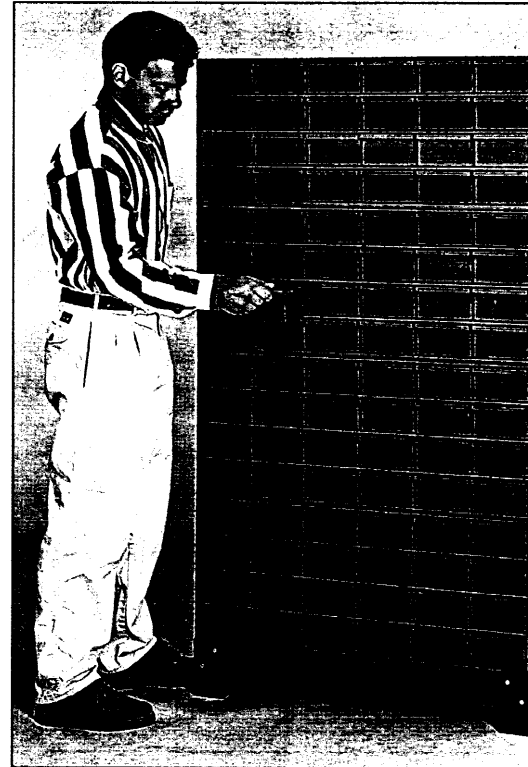

SIZE: PART #	SIZE: PART #	SIZE: PART #	SIZE: PART #	SIZE: PART #	SIZE: PART #
SIZE: PART #	SIZE: PART #	SIZE: PART #	SIZE: PART #	SIZE: PART #	SIZE: PART #
SIZE: PART #	SIZE: PART #	SIZE: PART #	SIZE: PART #	SIZE: PART #	SIZE: PART #
SIZE: PART #	SIZE: PART #	SIZE: PART #	SIZE: PART #	SIZE: PART #	SIZE: PART #

Labels for drawers and dividers are available. Black on white pressure sensitive labels are printed 36 per page and sold in 10 page sets.

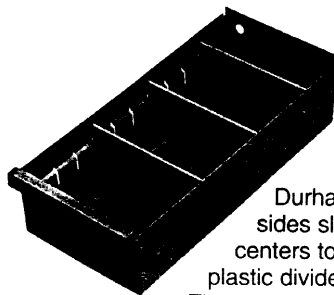

Durham drawers feature sides slotted on one inch centers to hold high impact plastic dividers firmly in place. They also have two easy glide runners and full width handles.

SPECIFICATIONS	MODEL		
	017 (48D)	019 (72D)	022 (96D)
Width, inches	34 $\frac{1}{2}$	34 $\frac{1}{2}$	34 $\frac{1}{2}$
Height, inches (includes base with legs)	33 $\frac{3}{4}$	48 $\frac{1}{2}$	62 $\frac{1}{2}$
Depth, inches	12 $\frac{1}{4}$	12 $\frac{1}{4}$	12 $\frac{1}{4}$
No. of Drawers	48	72	96
Drawer Width, inches	5 $\frac{3}{8}$	5 $\frac{3}{8}$	5 $\frac{3}{8}$
Drawer Height, inches	2 $\frac{3}{4}$	2 $\frac{3}{4}$	2 $\frac{3}{4}$
Drawer Depth, inches	11 $\frac{1}{4}$	11 $\frac{1}{4}$	11 $\frac{1}{4}$
Drawer Dividers	96	144	192
Material	Prime cold rolled steel – interlocking and welded construction		
Color	Gray baked enamel		
Packing per Carton	1 pallet	1 pallet	1 pallet

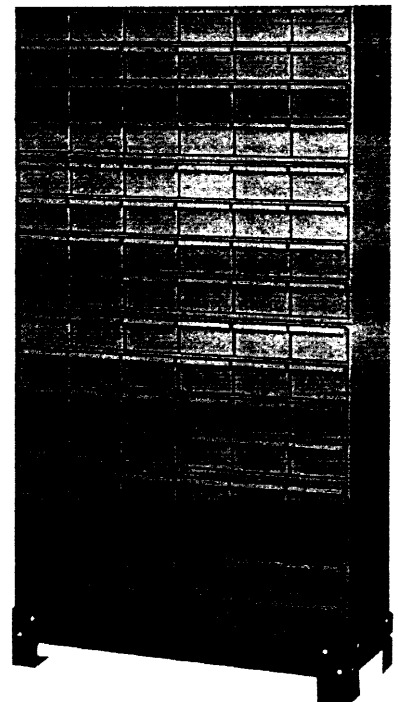

MODEL 022
(96D)

RACKS FOR SMALL SCOOP COMPARTMENT BOXES

Durham's Small Racks (SR) are designed to hold small scoop compartment boxes. They are manufactured of prime cold rolled steel and are finished in rust and acid resistant baked enamel. All parts, including cradles which support scoop boxes, and coated slides and tracks, are tooled for

quality and uniformity. A center panel on each cradle supports boxes and special stops prevent units from being accidentally pulled from the rack. Racks are reinforced for strength and support loaded boxes in the open position without tilting.

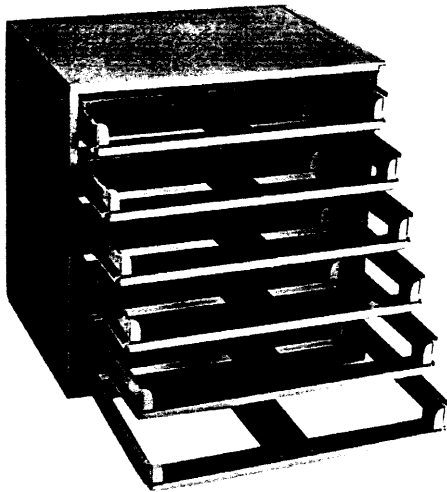

MODEL 308*
(6SR)

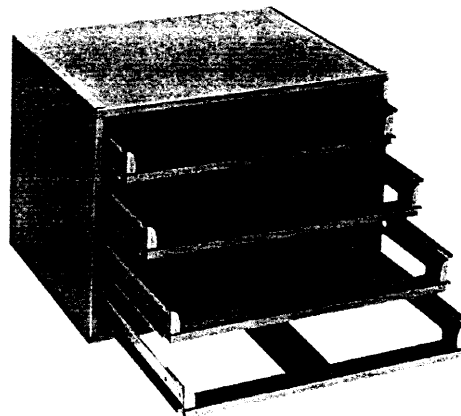

MODEL 307*
(4SR)

MODEL 315* (BSR) rack base (15½"W x 15½"H x 12½"D; weight 12 lbs.) available for all small (SR) slide racks.

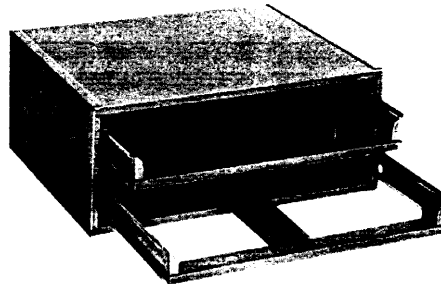
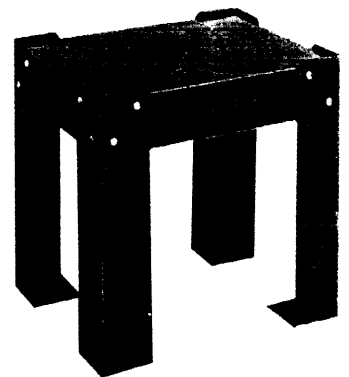

MODEL 306*
(2SR)



Plated locking hinges with swivel padlock attachments are available. **MODELS 313*** for use with the Model 307, and 312*, for use with the Model 308, lock scoop boxes into the racks and hold them securely in place. They have mounting holes and can be easily installed using sheet metal screws or pop rivets. Padlock not provided.

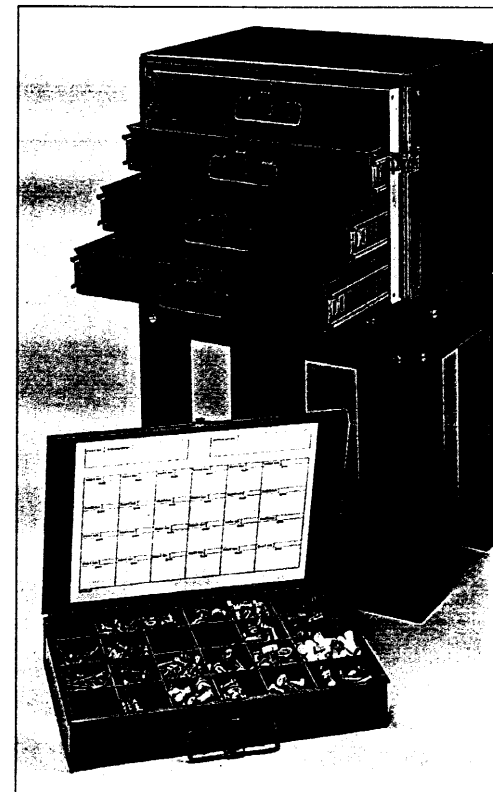
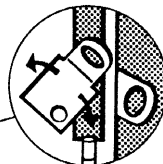
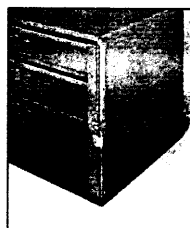

Small Scoop Compartment Boxes (DS) are sold separately. Refer to page six.

SPECIFICATIONS	MODEL			
	306* (2SR)	307* (4SR)	308* (6SR)	315* (BSR)
Width, inches	15¼	15¼	15¼	15½
Height, inches	6¼	11¼	16¾	15½
Depth, inches	11¾	11¾	11¾	12¾
Material	Prime cold rolled steel - interlocked and welded construction			
Color	Gray baked enamel			
No. of Drawers	2	4	6	N/A
Packing per Carton	1	1	1	1

*Ship via



RACKS FOR LARGE SCOOP COMPARTMENT BOXES

Durham's Large Racks (LR) for Large Scoop Compartment Boxes are produced using the same high quality construction as the small racks described on page seven. A specially designed Triple-Track space saver model has telescoping tracks which allows stacking on 12" Deep Bins and Drawer Cabinets.

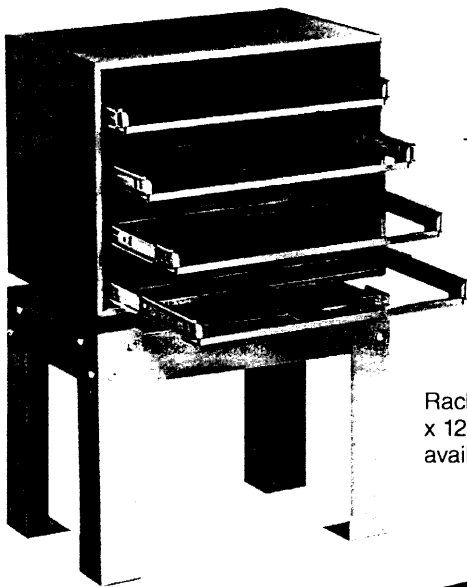

MODEL 310*
(4LR-TT)
Triple-Track Rack.

MODEL 311*
(BLR-TT)
Rack Base (20 $\frac{3}{8}$ "W x 15 $\frac{1}{8}$ "H x 12 $\frac{1}{8}$ "D; weight 13 lbs.) is available for use with 4LR-TT.

MODEL 302*
(2LR)

MODEL 303*
(4LR)

MODEL 304*
(BLR)
Rack Base (20 $\frac{3}{8}$ "W x 15 $\frac{1}{8}$ "H x 16"D; weight 13 lbs.) is available for use with Models 302 and 303.

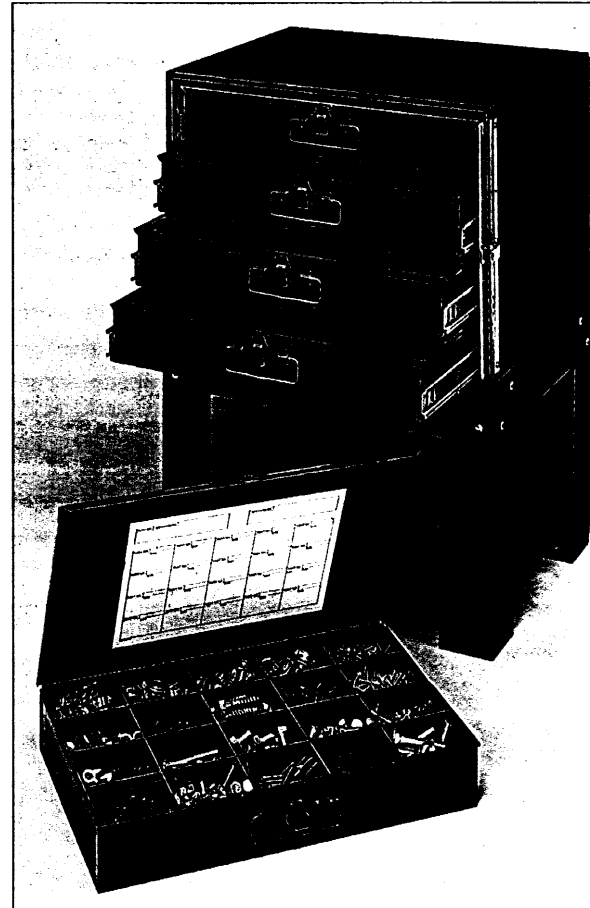
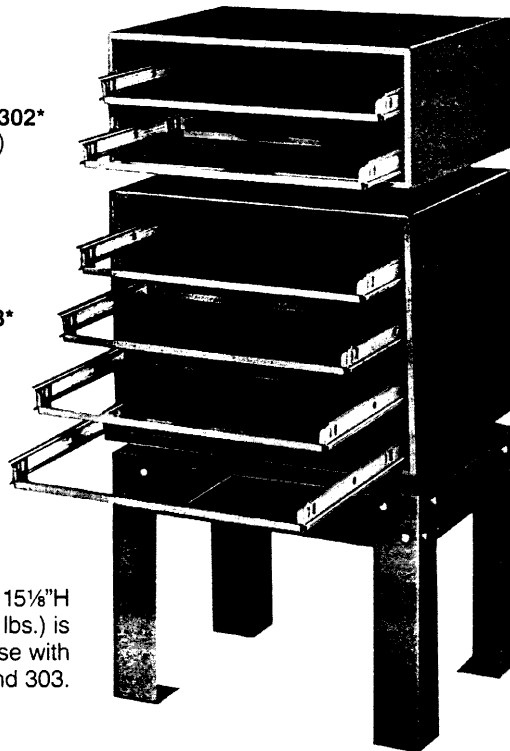

Large Scoop Compartment Boxes (DL) are sold separately. Refer to page eight.



MODEL 312* plated locking hinge with swivel padlock attachment is available for Models 303 (4LR) and 310 (4LR-TT) to lock drawers into the racks and hold them securely in place. They have mounting holes and can be easily installed using sheet metal screws or pop rivets. Padlock not provided.

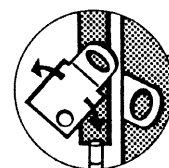
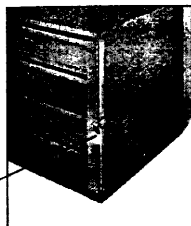

	MODEL		
SPECIFICATIONS	302* (2LR)	303* (4LR)	310* (4LR-TT)
Width, inches	20	20	20 $\frac{1}{4}$
Height, inches	8 $\frac{7}{8}$	15	15
Depth, inches	15 $\frac{1}{4}$	15 $\frac{1}{4}$	12 $\frac{1}{2}$
Material	Prime cold rolled steel - interlocked and welded construction		
Color	Gray baked enamel		
No. of Drawers	2	4	4
Packing per Carton	1	1	1
Weight per Carton, lbs.	20	27	20

*Ship via
UPS

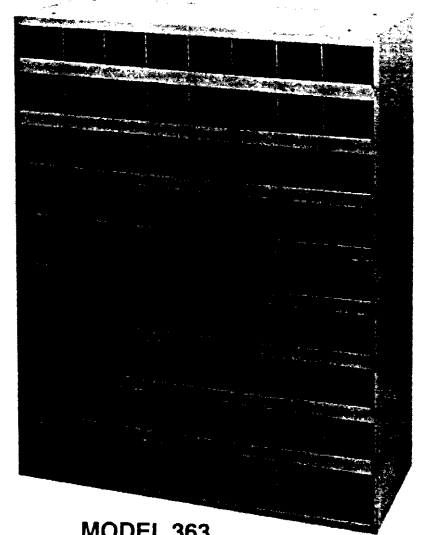
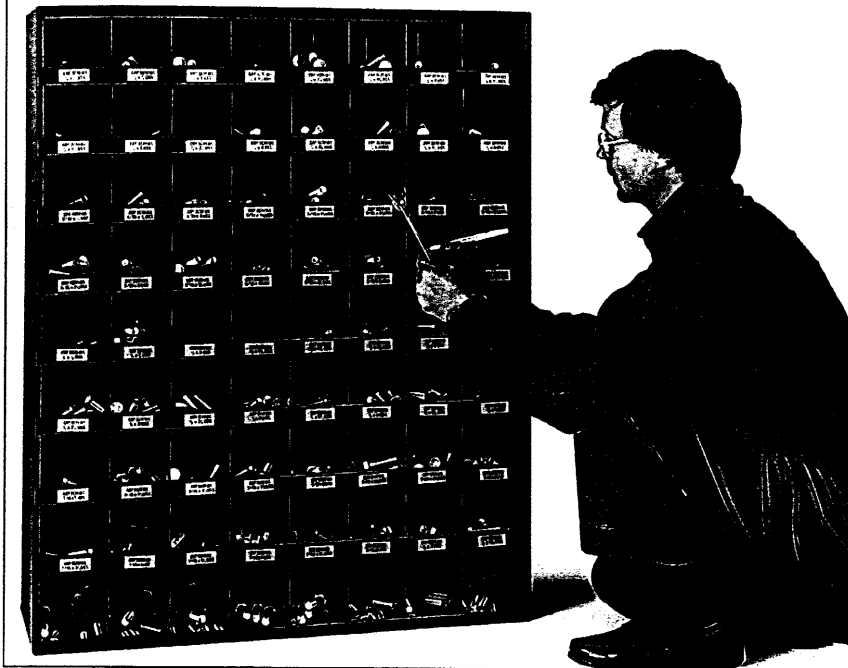

MODEL 363
(72B)

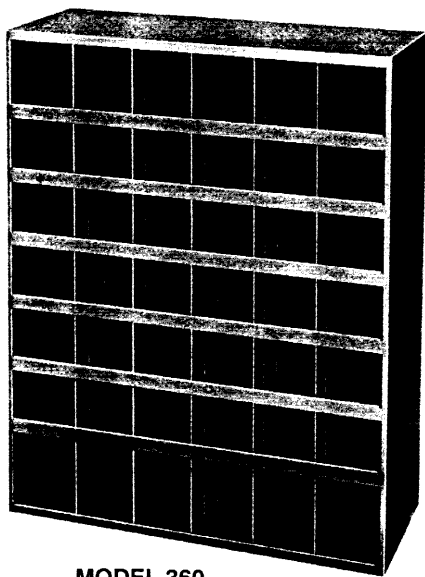

MODEL 360
(42B)

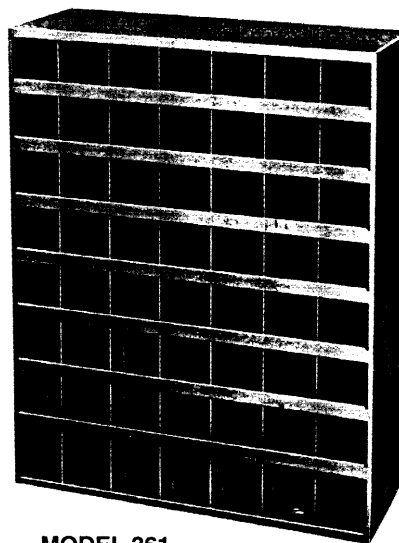

MODEL 361
(56B)



Exclusive hemmed and ribbed dividers add strength to all Durham Bins.

MODEL 366* Hinged door set with padlock attachment is available for Models 356 (24B) and 359 (40B). **MODEL 365*** hinged door set with padlock attachment is available for Models 360 (42B), 361 (56B), and Model 363 (72B).

They are shipped separately and attached using sheet metal screws or pop rivets. Padlock not provided.

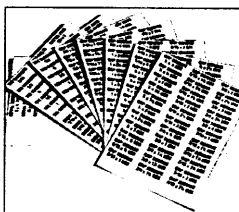

Pressure Sensitive Bin Labels are available for use with all parts bins. **USS or SAE Cap Screw Sets** consist of six pages each and are printed black on heavy coated yellow paper. **Metric Sets**

consist of nine pages printed black on heavy coated white paper. Six-page **Miscellaneous Sets** which include carriage bolts, plow bolts, stove bolts, nuts, washers, cotter pins, and sheet metal screws are printed black on heavy coated yellow paper. **Stainless Steel Sets** consist of four pages and are printed black on heavy coated silver paper. **Blank Labels** (36 per page) are available in white or yellow and are sold in 10 page sets.

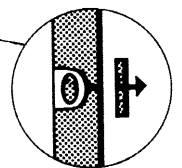
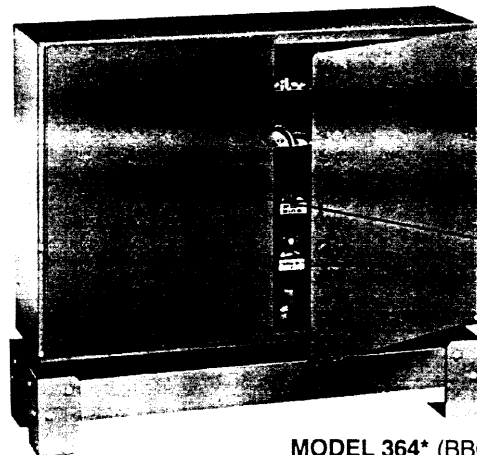

MODEL 364* (BBC-12) Bin Base is available for all models except the 355 and 358. The (BBC-12) is 5 $\frac{3}{4}$ "H x 34 $\frac{1}{8}$ "W x 12 $\frac{1}{4}$ "D; weight 13 lbs. It is sold separately. Legs can be attached by using fasteners provided.

All 12" Deep Bins are modular for use with 12" Deep Drawer Cabinets. Refer to pages 2, 3, and 4.

9" DEEP BINS

Durham's 9" Deep Bins feature the same quality construction as the 12" deep models described on pages 10 and 11. They are ideal for use when floor space is at a premium or the full 12" depth is not needed. All 9" Deep Durham Bins are modular and easily combined to make

larger units. Parts are accessible, and a 1 1/8" turn on each shelf provides space to hold labels for content identification.

All 9" Deep Bins ship via UPS with the exception of the Model 350 (9" 72B-1).

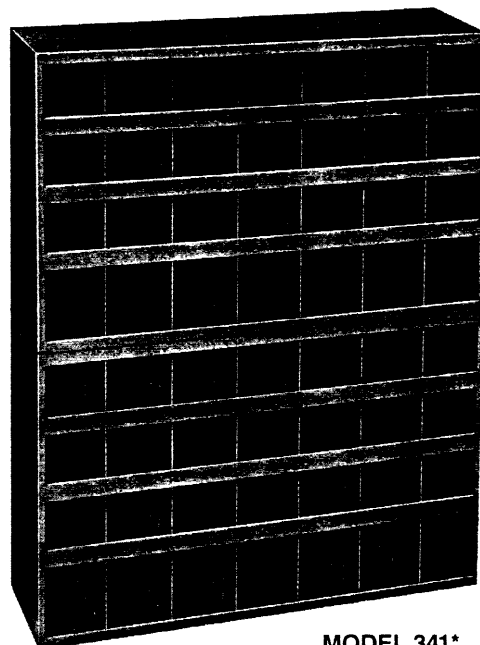

MODEL 341*
(9" 56B)

Ships via UPS in two parts (2 Model 340).

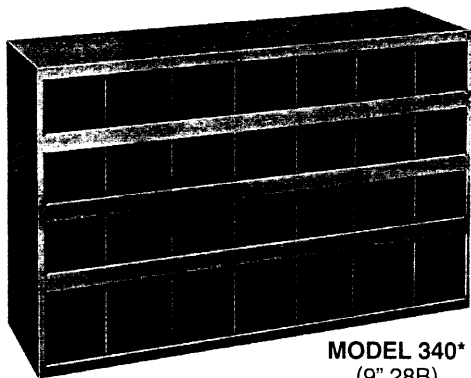

MODEL 340*
(9" 28B)

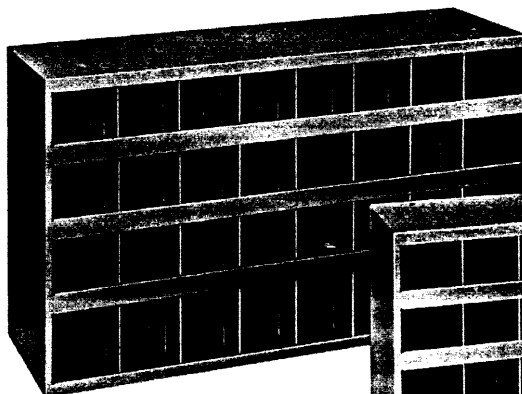

MODEL 344*
(9" 32B)

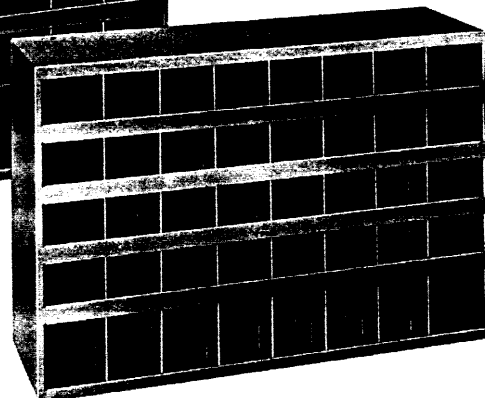

MODEL 349*
(9" 40B)

9" Deep Bin Base

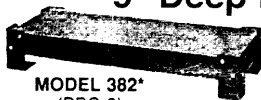

MODEL 382*
(BBC-9)

Sturdy, all-steel Bin base available for use with the 9" Deep Bins listed below.

Model	H"xW"xD"	Weight (lbs.)	Use with Bin Models
382	5 3/4"x34"x9"	11	340, 344, 349, 341, 350, 348

*Ship via UPS



Pressure Sensitive Bin Labels are available, see page 11 for details.

SPECIFICATIONS	MODEL					
	340* (9" 28B)	344* (9" 32B)	349* (9" 40B)	341* (9" 56B)	350 (9" 72B-1)	348* (9" 72B-2)
Width, inches	33 3/4	33 3/4	33 3/4	33 3/4	33 3/4	33 3/4
Height, inches	21	19 1/4	22 1/4	42	42	42
Depth, inches	8 1/2	8 1/2	8 1/2	8 1/2	8 1/2	8 1/2
No. of Bins	28	32	40	56	72	72
Bin Width, inches	4 7/8	4	4	4 7/8	4	4
Bin Height, inches	4 3/8	4 1/2	4	4 5/8	4 1/2	4 1/2
Bin Depth, inches	8 3/8	8 3/8	8 3/8	8 3/8	8 3/8	8 3/8
Material	Prime cold rolled steel - interlocked and welded construction					
Color	Gray baked enamel					
No. of Cartons	1	1	1	2	1	2

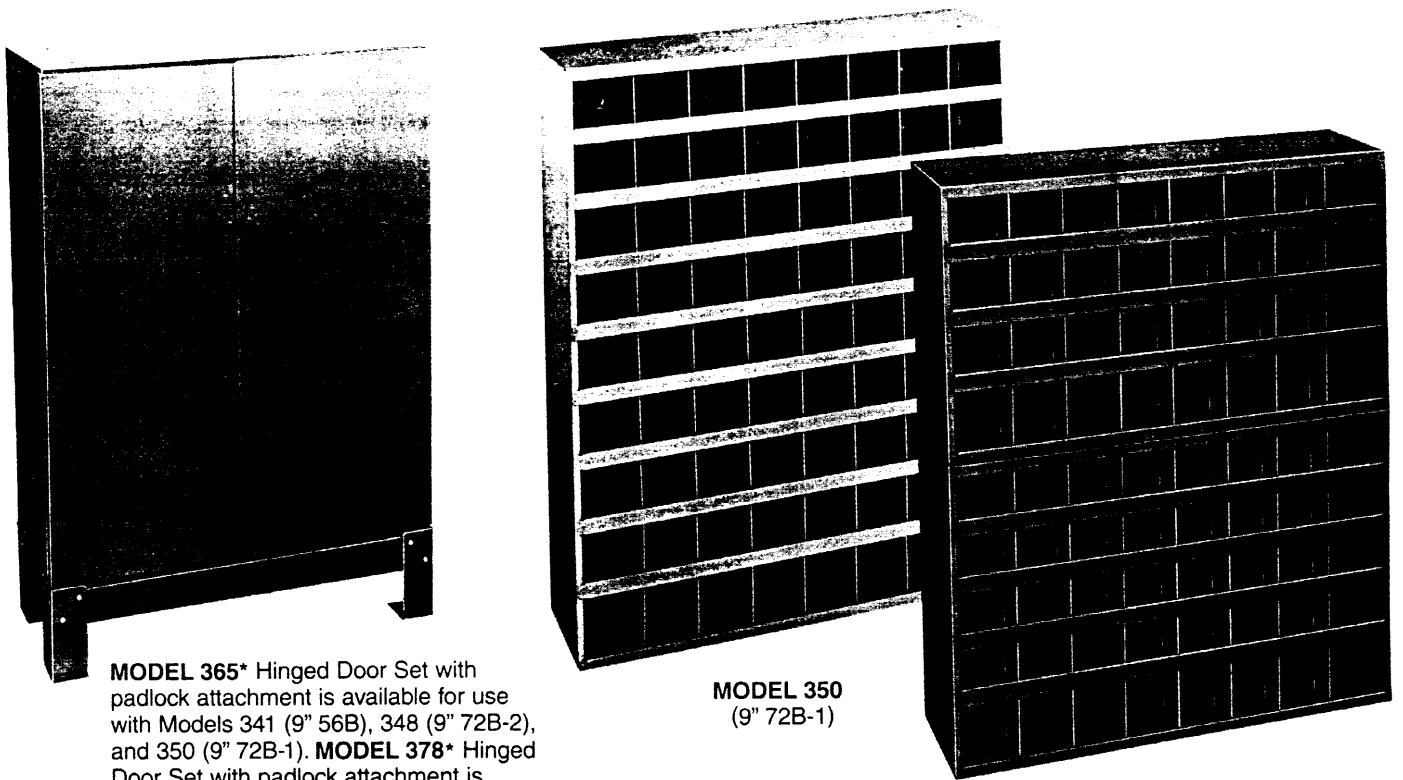

MODEL 365* Hinged Door Set with padlock attachment is available for use with Models 341 (9" 56B), 348 (9" 72B-2), and 350 (9" 72B-1). **MODEL 378*** Hinged Door Set with padlock attachment is available for use with Model 349 (9"40B). They are shipped separately and attached using sheet metal screws or pop rivets. Padlock not provided. Bases for 9" Deep Bins are also available. For information refer to page 12.

MODEL 350
(9" 72B-1)

MODEL 348* (9" 72B-2)
Ships via UPS in two parts
1 Model 344 and 1 Model 349.

MULTI-PURPOSE BINS



MODEL 319*
(MB-18)

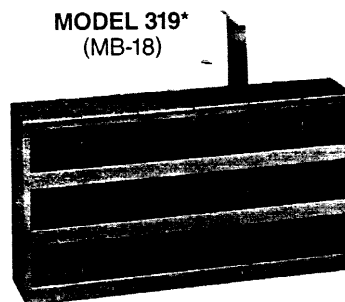

Dura-Hang™ Panel Hangers are available. See page 15.

MODEL 314*
(MB-36)

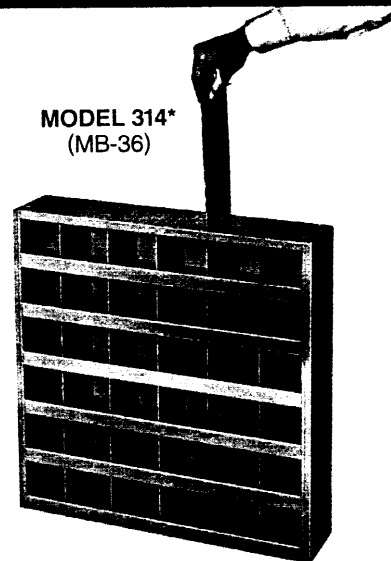

SPECIFICATIONS	MODEL	
	319* (MB-18)	314* (MB-36)
Width, inches	23 $\frac{3}{4}$	23 $\frac{3}{4}$
Height, inches	12 $\frac{1}{4}$	23 $\frac{3}{4}$
Depth, inches	4 $\frac{1}{4}$	4 $\frac{1}{4}$
No. of Bins	18	36
Bin Width, inches	3 $\frac{7}{8}$	3 $\frac{7}{8}$
Bin Height, inches	3 $\frac{3}{4}$	3 $\frac{3}{4}$
Bin Depth, inches	4 $\frac{1}{8}$	4 $\frac{1}{8}$
Material	Prime cold rolled steel – interlocking construction	
Color	Gray baked enamel	
Packing per Carton	1	1
Weight per Carton, lbs.	12	25



Durham's heavy-duty, all steel Multi-Purpose Bins feature removable vertical dividers for the creation of multi-width compartments. Scooped shelves allow contents to be easily removed. These bins are ideal for the storage of fasteners, electrical connectors, fittings, and most other small components. Keyhole slots are provided for wall mounting. These bins are 23 $\frac{3}{4}$ " wide and can be easily attached to the end of back-to-

SMALL PLASTIC COMPARTMENT BOXES

11"W x 1¾"H x 6¾"D

Durham Small Plastic Compartment Boxes (SP) are ideal for organizing, storing and protecting a wide variety of small parts. Four different configurations provide a wide selection of compartment sizes and shapes to fit just about every need.

Manufactured of high strength, oil resistant polypropylene, Durham Plastic Compartment Boxes are furnished with heavy duty reinforced hinges that have a special feature

which allows the cover to stand up in the open position. Each cover is designed to overlap on all sides of the box, fitting snugly against a shelf-like ledge. This results in extra protection against dirt, dust and moisture. Two snap latches assure secure closure and prevent parts from moving between compartments. These boxes are available in transparent or opaque yellow and are stackable.

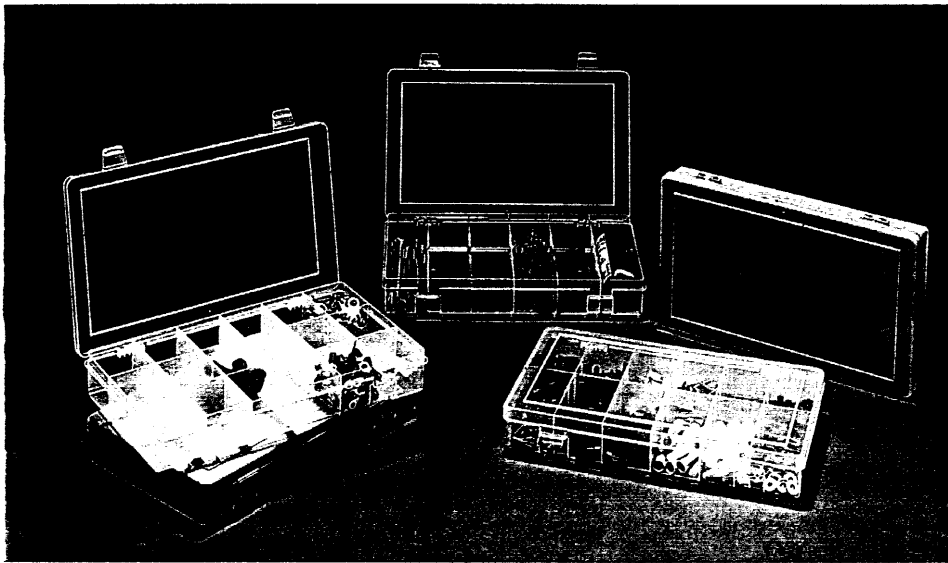

Customized hot stamping of company logos available on both transparent and opaque yellow models.

An optional locking hinge **MODEL 313*** is offered for use with either MODEL 290 (SPR) or 291 (LPR) to hold boxes in place when being transported in a moving vehicle. Padlock not provided.

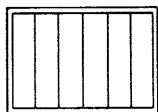
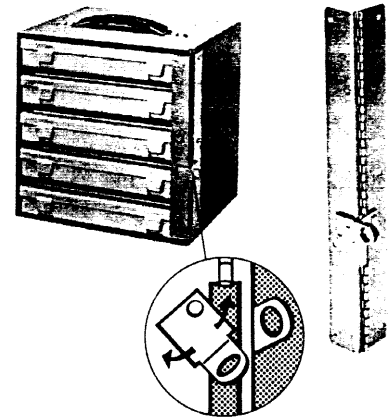

MODEL SP-6
Six Compartments

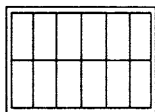

MODEL SP-12
Twelve Compartments

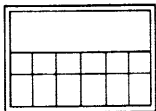

MODEL SP-13
Thirteen Compartments

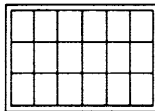

MODEL SP-18
Eighteen Compartments

The **MODEL 290*** (SPR) Rack is manufactured of cold rolled steel and finished in durable gray baked enamel. The unit holds 5 MODEL SP Plastic Compartment Boxes to create a compact and efficient small parts storage system. The versatile rack has been designed for three way use. Keyhole slots are furnished for wall mounting. A handle is provided and bolt holes permit stacking. Boxes sold separately.

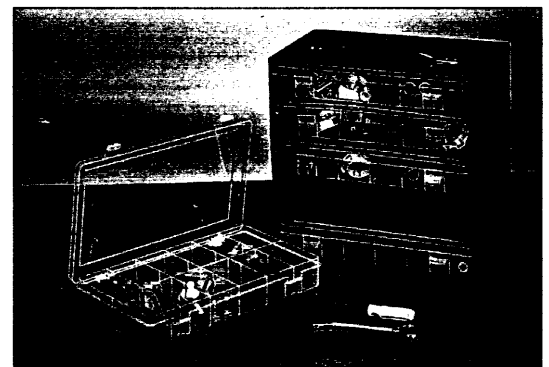

The removable handle is offset to hold the boxes securely while being carried.

*Ship via
UPS



SPECIFICATIONS	SP-6*	SP-12*	MODEL SP-13*	SP-18*	290* (SPR)
Width, inches	11	11	11	11	11¼
Height, inches	1¾	1¾	1¾	1¾	10¾
Depth, inches	6¾	6¾	6¾	6¾	6¾
No. of Compartments	6	12	13	18	N/A
Cpt. Width, (i.d.)	1¾	1¾	1¾, 10½	1¾	N/A
Cpt. Height, (i.d.)	1⅞	1⅞	1⅞	1⅞	N/A
Cpt. Depth, (i.d.)	6¼	3⅞	2⅞, 1¾, 2	2	N/A
Packing per Carton	10 or 50	10 or 50	10 or 50	10 or 50	1
Ship Weight, lbs.	7 or 31	7 or 31	7 or 31	7 or 31	7
Material	Polypropylene				Cold rolled steel
Color	Transparent or Yellow				Gray
Back Capacity	N/A	N/A	N/A	N/A	N/A

LARGE PLASTIC COMPARTMENT BOXES

13 $\frac{1}{8}$ "W x 2 $\frac{5}{16}$ "H x 9"D

Durham's Large Plastic Compartment Boxes (LP) have all the same features of the Small Plastic Compartment Boxes. They also offer different internal configurations and rounded scoop compartments for easy removal of parts.



Customized hot stamping of company logos available on both transparent and opaque yellow models.

Dura-Hang™ Panel Hangers are available to hang either Model 290 (SPR) or 291 (LPR) racks on movable partitions. They are easily adjustable to fit up to 3 $\frac{3}{8}$ " wide panels.

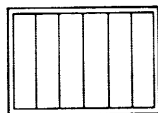
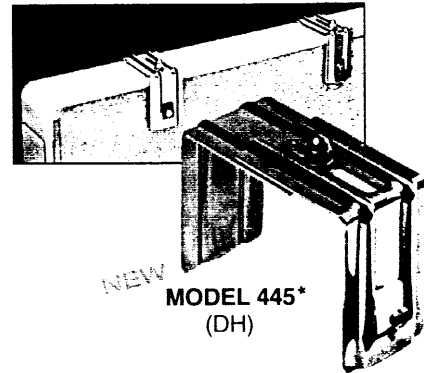

MODEL LP-6
Six Compartments

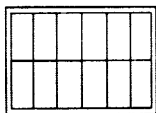

MODEL LP-12
Twelve Compartments

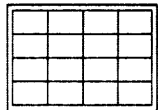

MODEL LP-16
Sixteen Compartments

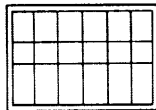

MODEL LP-18
Eighteen Compartments

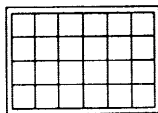

MODEL LP-24
Twenty Four Compartments

The **MODEL 291 (LPR) Rack** is identical to the **MODEL 290 (SPR) Rack** except for its larger size. The unit holds 5 LP Plastic Compartment Boxes to create a compact and efficient small parts storage system. It is manufactured of cold rolled steel and finished in gray baked enamel. Keyhole slots are furnished for wall mounting. A handle is provided and bolt holes permit stacking. Boxes sold separately.

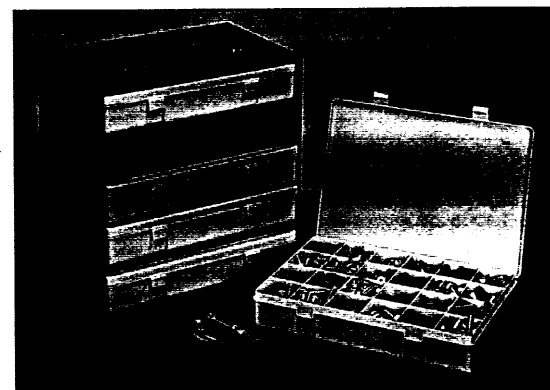

The removable handle is offset to hold the boxes securely while being carried.

SPECIFICATIONS	MODEL					
	LP-6*	LP-12*	LP-16*	LP-18*	LP-24*	291* (LPR)
Width, inches	13 $\frac{1}{8}$	13 $\frac{1}{8}$	13 $\frac{1}{8}$	13 $\frac{1}{8}$	13 $\frac{1}{8}$	13 $\frac{1}{2}$
Height, inches	2 $\frac{5}{16}$	2 $\frac{5}{16}$	2 $\frac{5}{16}$	2 $\frac{5}{16}$	2 $\frac{5}{16}$	13 $\frac{1}{4}$
Depth, inches	9	9	9	9	9	9 $\frac{1}{2}$
No. of Compartments	6	12	16	18	24	N/A
Cpt. Width, (i.d.)	2 $\frac{1}{16}$	2 $\frac{1}{16}$	3 $\frac{1}{16}$	2 $\frac{1}{16}$	2 $\frac{1}{16}$	N/A
Cpt. Height, (i.d.)	2	2	2	2	2	N/A
Cpt. Depth, (i.d.)	8 $\frac{1}{2}$	4 $\frac{1}{4}$	2 $\frac{1}{16}$	2 $\frac{1}{16}$, 4 $\frac{1}{4}$	2 $\frac{1}{16}$	N/A
Packing per Carton	5 or 20	5 or 20	5 or 20	5 or 20	5 or 20	1
Ship Weight, lbs.	7 or 24	7 or 24	7 or 24	7 or 24	7 or 24	11
Material	Polypropylene					Cold rolled steel
Color	Transparent or Yellow					Gray
Back	N/A	N/A	N/A	N/A	N/A	5 LP's



CON-TUR® LITERATURE RACKS

Durham all steel Con-Tur® Literature Racks provide a convenient and compact way to store literature while keeping it readily accessible and visible. Each pocket is designed to hold up to 150 sheets of 8½" x 11" literature with the top 2½" remaining visible for content identification. There are keyhole

slots for wall mounting and pre-assembled optional legs may be used to make any rack free standing. Colors available are tan, putty, gray or black. The new Durham Con-Tur® design totally eliminates paper curl.

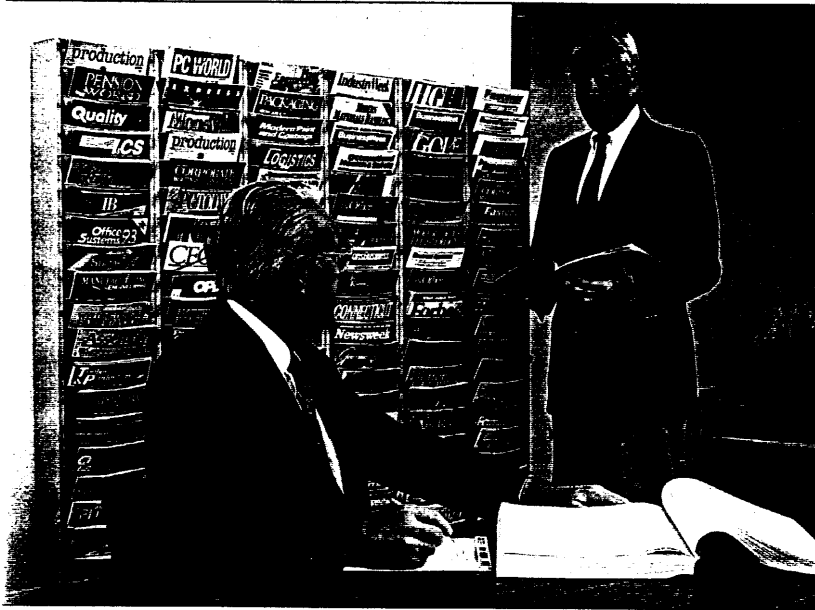

NEW

Dura-Hang™ Panel Hangers are available to hang Con-Tur® Horizontal Literature Racks on movable partitions. They are easily adjustable to fit up to 3¾" wide panels.

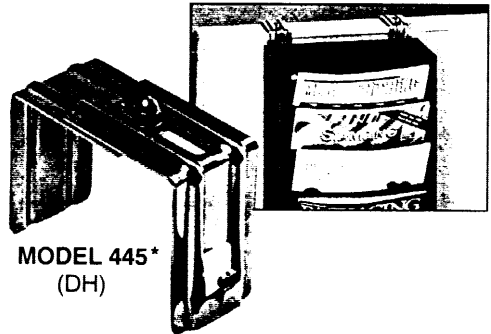

MODEL 445*
(DH)

MODEL 408A
Pre-Assembled Legs are available for use with all Con-Tur® Literature Racks and allow them to be made into free standing units.

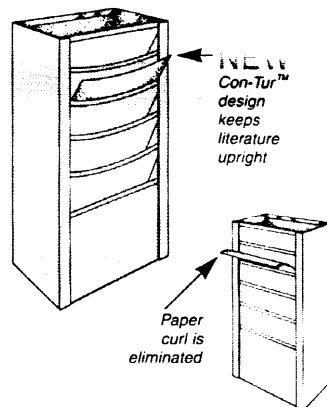

MODEL 401*
(31)
23 pockets

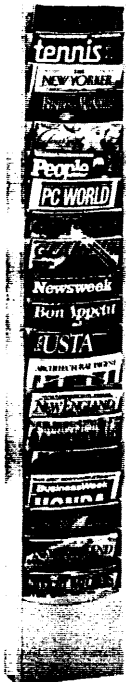

MODEL 400*
(20)
20 pockets



MODEL 402*
(32)
11 pockets



MODEL 403*
(33)
5 pockets

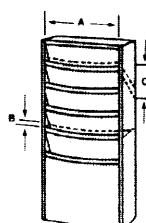

*Ship via
UPS

SPECIFICATIONS	MODEL			
	401* (31)	400* (20)	402* (32)	403* (33)
Width, inches	9¾	9¾	9¾	9¾
Height, inches	65	58½	36	21
Depth, inches	4	4	4	4
A. Opening, Width, inches	8½	8½	8½	8½
B. Opening, Height, inches	¾	¾	¾	¾
C. Opening, Depth, inches	8½	8½	8½	8½
Paper Width, inches	8½	8½	8½	8½
No. of Pockets	23	20	11	5
Packing per Carton	1	1	1	1
Weight per Carton, lbs.	22	20	15	9

ROTARY CON-TUR® LITERATURE RACKS

Durham Rotary Con-Tur® Literature Racks provide the ideal way to store and display a wide variety of literature in a compact area. These sturdy four-sided racks rotate on ball-bearing turntables making all materials easily visible as

well as accessible. When standard 8½" x 11" literature is displayed, the top 2½" is exposed for easy identification. All models are available in tan, putty, gray or black.

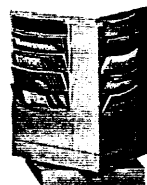

MODEL 409*
(2033R)
20 pockets



MODEL 410*
(4032R)
44 pockets



MODEL 416*
(8020R)
80 pockets

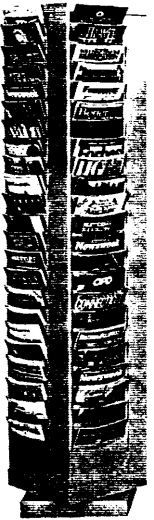

MODEL 415*
(8831R)
92 pockets

HORIZONTAL LITERATURE RACKS

Durham's all steel Horizontal Literature Racks for floor or desk top use, provide handy storage for literature in 3" high sections. Eleven inch wide openings allow for file folders and other oversized literature to be stored without bending. These racks are reinforced and will not warp or twist. They are shipped set up, ready for use, and may be arranged vertically or horizontally. Fasteners are provided to join individual racks which are available with 9, 12 or 15 openings. Each rack comes with a set of 4 rubber feet for desk or counter top protection. All units are finished in tan baked enamel.

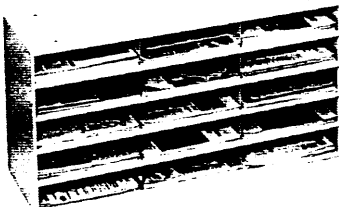

MODEL 434-75*
(HLR-15)



MODEL 432-75*
(HLR-12)

MODEL 431-75*
(HLR-9)

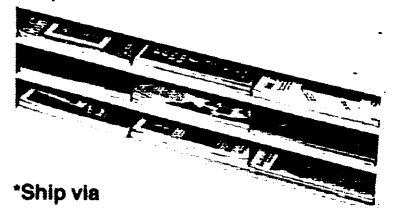

SPECIFICATIONS	MODEL						
	431-75* (HLR-9)	432-75* (HLR-12)	434-75* (HLR-15)	409* (2033R)	410* (4032R)	416* (8020R)	415* (8831R)
Width, inches	33¾	33¾	33¾	14½	14½	14½	14½
Height, inches	10¾	14¼	17¾	23	50¾	60¾	68¼
Depth, inches	11½	11½	11½	14½	14½	14½	14½
A. Opening, Width, inches	11	11	11	8½	8½	8½	8½
B. Opening, Height, inches	3	3	3	1	1	1	1
C. Opening, Depth, inches	11½	11½	11½	8½	8½	8½	8½
Paper Width, inches	8½	8½	8½	8½	8½	8½	8½
No. of Pockets/Opening	9	12	15	20	44	80	92
No. of Cartons	1	1	1	5	5	5	5
Total Weight, lbs.	21	27	33	57	57	121	120

*Ship via
UPS

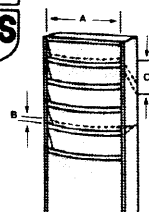

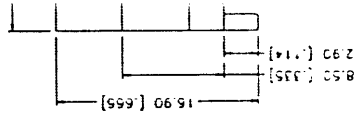

VERTICAL LITERATURE-FORMS RACKS

Durham's Vertical Literature-Form Racks have been designed with 12 1/4" wide pockets. The top 2 1/2" of the stored materials remain visible for easy identification. Keyhole slots are provided for wall mounting. Available in tan, putty, gray and black.

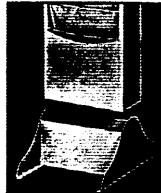
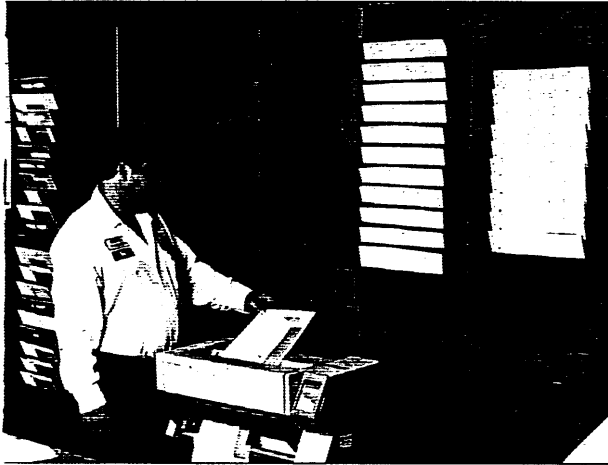

MODEL 407A* Pre-assembled
Legs can be used to make Model
405 (32-12) and 406 (20-12)
free standing.

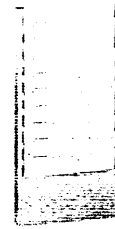

MODEL 406*
(34-12)

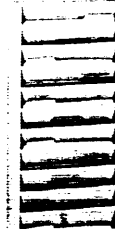

MODEL 405*
(32-12)



MODEL 411*
(20-12)

Dura-Hang™ Panel Hangers are available for use with all products on this page. See page 16 for details.

PLASTIC DRAWER, AEROSOL/UTILITY CABINETS

Heavy duty steel cabinets **MODEL 317*** (BFC-64) and **016*** (BFC-20) include scooped drawers made of clear K-Resin plastic which will not crack or break under normal use.

The **MODEL 343*** (AU1) is divided into four sections and includes a lock and two keys. The **MODELS 055*** (AU2) and **056*** (AU3) each feature two adjustable shelves and a lock attachment. Padlock not provided. Keyhole slots allow easy wall mounting.

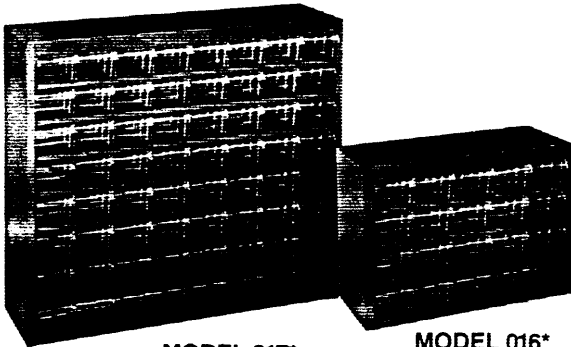

MODEL 317*
(BFC-64)

MODEL 016*
(BFC-20)

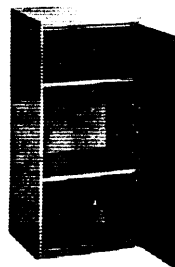

MODEL 055*
(AU2)

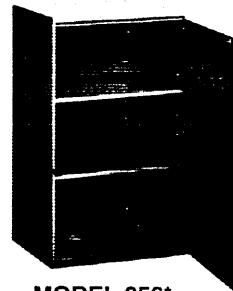

MODEL 056*
(AU3)



MODEL 385*
(AC6)
Aerosol can caddy

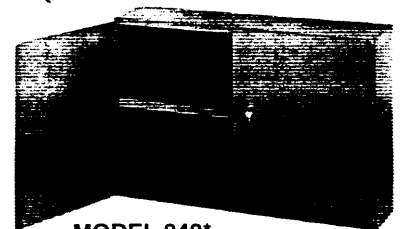

MODEL 343*
(AU1)



Each drawer, measuring 2 1/8"W x 1 7/8"H x 5 1/2"D has lock-in dividers to keep small parts separated.

*Ship via
UPS

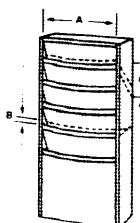

SPECIFICATIONS	MODEL								
	406* (34-12)	405* (32-12)	411* (20-12)	343* (AU1)	055* (AU2)	056* (AU3)	385* (AC6)	016* (BFC-20)	317* (BFC-64)
Width, inches	13 1/8	13 1/8	13 1/8	33 3/4	13 3/4	19 7/8	21 1/2	16 3/4	25 1/2
Height, inches	26	36	58 1/2	22 1/4	30	32 3/4	5 1/4	12	21 3/4
Depth, inches	2	4	4	8 1/2	12 3/4	14 1/4	3 1/8	6 3/8	6 3/8
A. Opening Width, inches	12 1/2	12 1/4	12 1/4						
B. Opening Depth, inches	5 1/8	1	1						
C. Opening Height, inches	6	8 3/8	10 3/8						
Paper Width, inches	12	12	12						
No. of Sections/Pockets	10	11	20	4	Adjustable	Adjustable	6	20	64
Material	Prime cold rolled steel - interlocking construction (Clear K-Resin Drawers)								
Color	Gray baked enamel								
Packing per Carton	1	1	1	1	1	1	1 & 12	1	1
Weight per Carton, lbs.	13	24	44	45	31	41	3 & 36	10	33

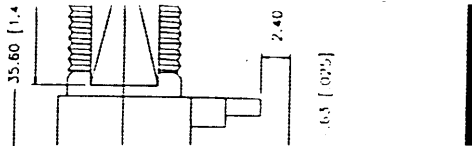

TRUCK/VAN PRODUCTS

These units have been specifically designed for use in customizing trucks and vans.



MODEL 806*
(DT-3)

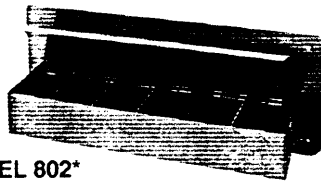

MODEL 802*
(DT-1)

The **MODELS 802*** (DT-1) and **806*** (DT-3) door trays, furnished with covers, provide convenient storage in otherwise unusable space. Adjustable dividers are also included.

MODEL 611*
(TB9D)

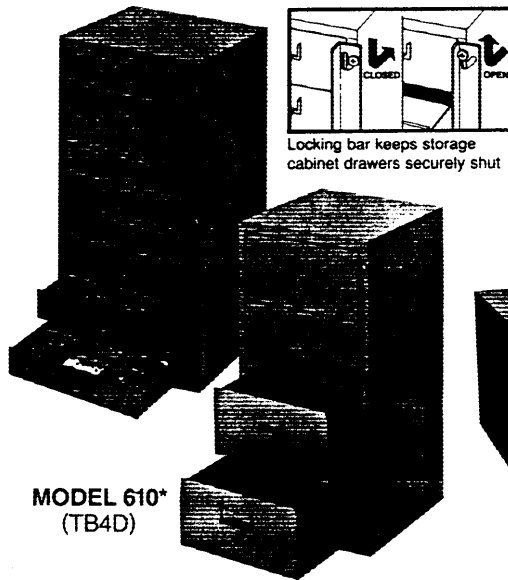

MODEL 610*
(TB4D)

The **MODEL 611*** (TB9D) has nine drawers with 81 adjustable dividers. The **MODEL 610*** (TB4D) has a fixed center partition in each of its four drawers. Both units feature locking bars to hold drawers in place in a moving vehicle. Padlock not provided.

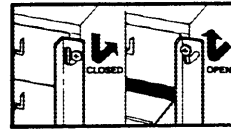

Locking bar keeps storage cabinet drawers securely shut

MODEL 307* (4SR) Slide Rack is designed to hold 4 Small Scoop Compartment Boxes. An optional locking hinge is available to prevent boxes from coming out when the vehicle is in motion. Boxes sold separately. (See pages 6-9 for similar units.)

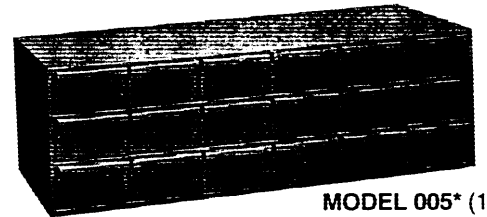
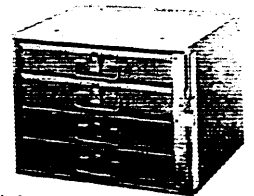

MODEL 005* (18D)
18 Drawer Cabinet
(See pages 2-4 for similar units.)

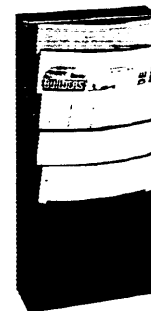

MODEL 403* (33) Literature Rack is easily mounted and is ideal for the storage of all standard 8½" wide literature. (See pages 16 and 18 for similar units.)

HOSE CLAMP RACKS

Hose Clamp Racks provide easy access to adjustable hose clamps. The **MODEL 907*** is designed to hold sizes from the smallest mini-clamp up to the 2¾" diameter #36 clamp. The **MODEL 905*** holds from the 2¼" diameter #40 to the 5" #72. For countertop use or may be wall-mounted using two built-in hanger loops provided. Sign panel lists clamp diameters.

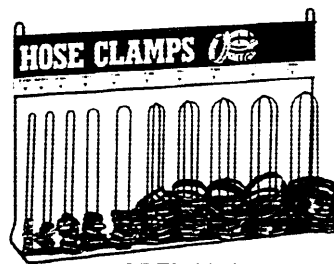

MODEL 907*
(10-loop clamp rack)

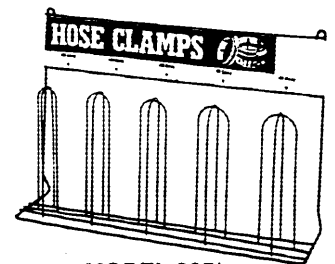

MODEL 905*
(5-loop clamp rack)

SPECIFICATIONS	MODEL								
	611* (TB9D)	610* (TB4D)	806* (DT-3)	802* (DT-1)	403* (33)	307* (4SR)	005* (18D)	905* (5 Loop)	907* (10 Loop)
Width, inches	12¾	12¾	21	21	9¾	15¼	33¾	23¼	23¼
Height, inches	24½	24½	21	8	20¼	11¼	10¾	16½	15¾
Depth, inches	12¾	12¾	4¾	4¾	4¾	11¾	11½	5¾	5¾
No. Drawers/Trays	9	4	3	1	N/A	4	18	5	10
No. Pockets/Open./Sect.	N/A	N/A	N/A	N/A	5	N/A	N/A	N/A	N/A
A. Opening, Width, inches	11	11	18¼	18¼	8½	N/A	5	N/A	N/A
B. Opening, Height, inches	2	4¾	3¼	3¼	8½	N/A	2¾	N/A	N/A
C. Opening, Depth, inches	10¾	10¾	4½	4½	1	N/A	11¾	N/A	N/A
No. of Dividers	81	0	9	N/A	N/A	N/A	36	N/A	N/A
Paper Width, inches	N/A	N/A	N/A	N/A	8½	N/A	N/A	N/A	N/A
Material	Heavy duty steel - interlocked and welded construction						Heavy duty wire		
Color	Gray baked enamel						Black baked enamel		
Packing per Carton	1	1	1	1	1	1	1	1	1
Weight per Carton, lbs.	46	32	18	8	9	22	50	5	5

*Ship via
UPS



723-9221 - 723 9210 - 723 9208

MISCELLANEOUS STORAGE UNITS

Durham offers a number of units designed for specialized storage applications. New items are being developed and added to the line based on the needs of the marketplace.

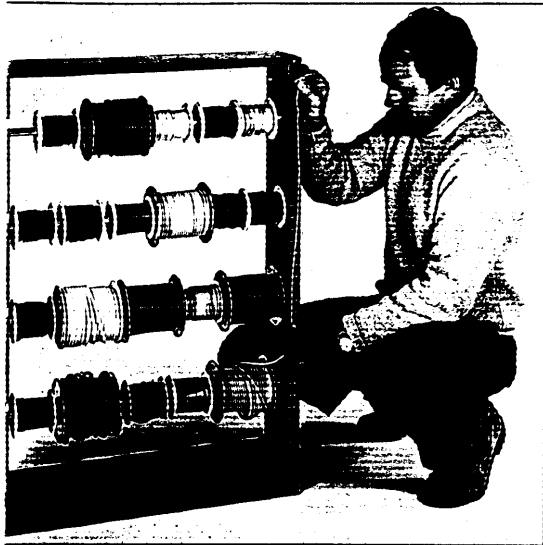

MODEL 368*
(WSR-4)

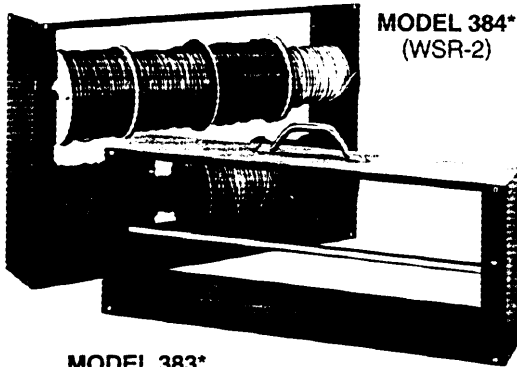

MODEL 384*
(WSR-2)

MODEL 383*
(WSR-1)

Durham's heavy duty Wire Spool Racks include models with one, two, and four plated $\frac{5}{8}$ " diameter steel rods for the convenient storing and dispensing of wire. The four rod rack (MODEL 368) holds spools up to 10" in diameter. The two rod rack (MODEL 384) is ideal for counter top use, and the single rod rack (MODEL 383) has a handle. All models are shipped knocked down and easily assembled.

*Ship via
UPS

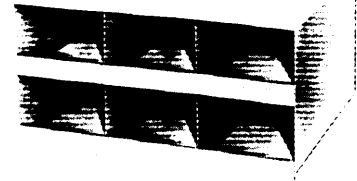

MODEL 921* Welding Rod Cabinet.
Holds welding rod up to 18" long in six compartments. Each compartment is 18 $\frac{3}{8}$ " deep x 4" high x 5 $\frac{1}{4}$ " wide.

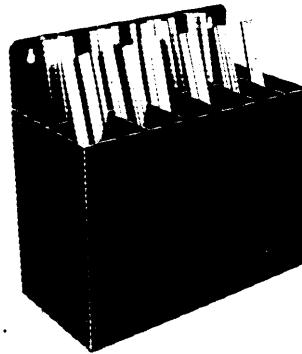

MODEL 381* Key Stock Rack.
Ten compartments hold key stock up to $\frac{3}{4}$ " square and approximately 12" long. Keyholes permit wall mounting.

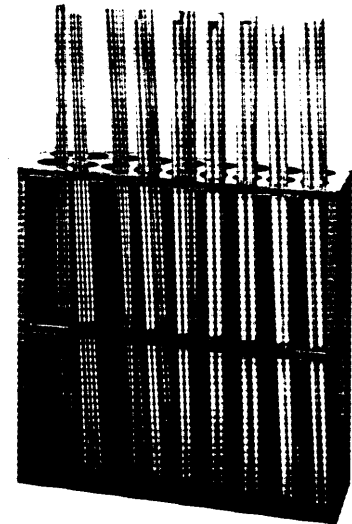

MODEL 367* Threaded Rod Rack.
Separates and protects threaded rods. Eighteen $2\frac{1}{16}$ " diameter openings accommodate different sizes. Shipped fully assembled.

SPECIFICATIONS	MODEL					
	368* (WSR-4)	384* (WSR-2)	383* (WSR-1)	381*	367*	921*
Width, inches	26 $\frac{1}{2}$	26 $\frac{1}{2}$	26 $\frac{1}{2}$	12 $\frac{1}{4}$	24 $\frac{1}{2}$	16 $\frac{1}{2}$
Height, inches	37 $\frac{1}{2}$	17 $\frac{1}{2}$	10 $\frac{3}{4}$	12	24	8 $\frac{1}{2}$
Depth, inches	6	6	6	6 $\frac{1}{4}$	6 $\frac{1}{2}$	18 $\frac{1}{2}$
No. of Sections	4	2	1	10	18	6
Material	Prime cold rolled steel - interlocking construction					
Color	Gray baked enamel					
Packing per Carton	1	1	1	1	1	1
Weight per Carton, lbs.	25	11	9	8	16	17

Models and specifications subject to change without notice.



THE DURHAM MANUFACTURING COMPANY
201 Main Street, P.O. Box 230, Durham, Connecticut 06422-0230
TEL: 1-(800)-243-3774 • FAX: 1-(800)-782-5499
IN CT: 1-(203)-349-3427 • FAX: 1-(203)-349-8572

DISTRIBUTED BY: