

2.5-6.0/5.0-12.0 GHz Active Doubler QFN, 4x4 mm

Mimix
BROADBAND™

March 2006 - Rev 24-Mar-06

XX1002-QH
RoHS

Features

- ✕ Octave Bandwidth Operation
- ✕ +17 dBm Output Power
- ✕ -35 dBc Fundamental Leakage
- ✕ +5.0V, 125mA Bias Supply
- ✕ SMD, 4x4 mm QFN Package
- ✕ RoHS Compliant
- ✕ 100% RF, DC and Output Power Testing



General Description

Mimix Broadband's 2.5-6.0/5.0-12.0 GHz SMD Active Doubler delivers + 17 dBm of output power. The device combines an active doubler with an output buffer amplifier that delivers constant power over a range of input powers. The device has excellent rejection of the fundamental and harmonic products and requires a single positive bias supply. This device uses Mimix Broadband's 2 um GaAs HBT device model technology to ensure high reliability and uniformity. The device comes in a low-cost 4x4 mm QFN Surface Mount Plastic Package offering excellent RF and thermal properties and is RoHS compliant. This device is well suited for Point-to-Point Radio, Microwave, LMDS, SATCOM and VSAT applications.

Absolute Maximum Ratings

Supply Voltage (Vcc)	+6.0 VDC
Supply Current (Id)	200 mA
Input Power (RF Pin)	+10.0 dBm
Storage Temperature (Tstg)	-65 to +165 °C
Operating Temperature (Ta)	-55 to MTTF Table ¹
Junction Temperature (Tj)	MTTF Table ¹

(1) Junction temperature affects a device's MTTF. It is recommended to keep junction temperature as low as possible for maximum life.

Electrical Characteristics (Ambient Temperature T = 25 °C)

Parameter	Units	Min.	Typ.	Max.
Input Frequency Range (fin)	GHz	2.5	-	6.0
Output Frequency Range (fout)	GHz	5.0	-	12.0
Input Return Loss (S11)	dB	-	-15	-
Output Return Loss (S22)	dB	-	-7	-
Saturated Output Power (Psat)	dBm	+14	+17	-
RF Input Power (RF Pin)	dBm	-3.0	-	+3.0
Fundamental Leakage (fin)	dBc	-	-35	-
Third Harmonic Leakage (3xfin)	dBc	-	-30	-
Fourth Harmonic Leakage (4xfin)	dBc	-	-20	-
Bias Voltage (Vcc)	VDC	-	+5.0	+5.5
Supply Current	mA	-	125	140



2.5-6.0/5.0-12.0 GHz Active Doubler QFN, 4x4 mm



March 2006 - Rev 24-Mar-06

XI002-QH
RoHS

Doubler Measurements

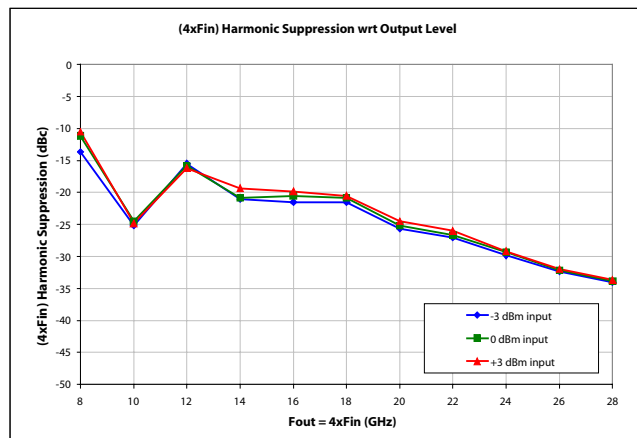
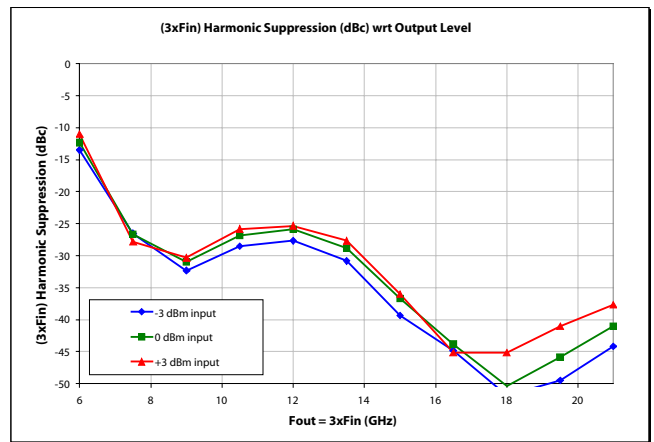
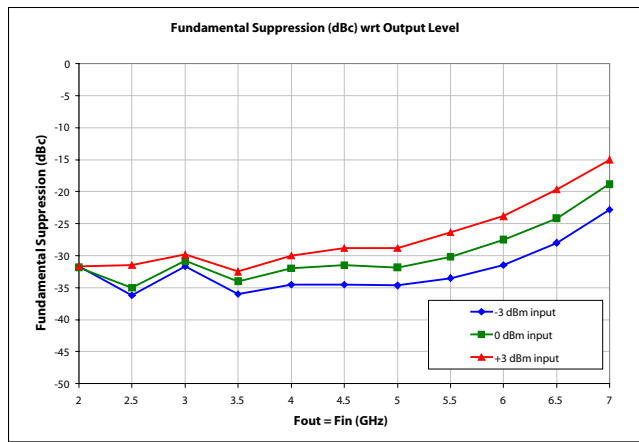
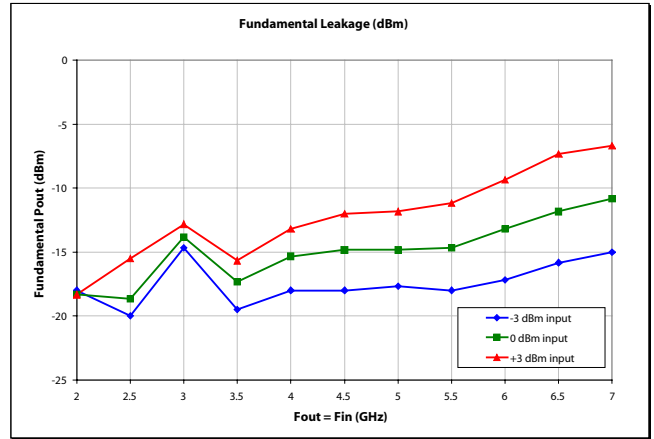
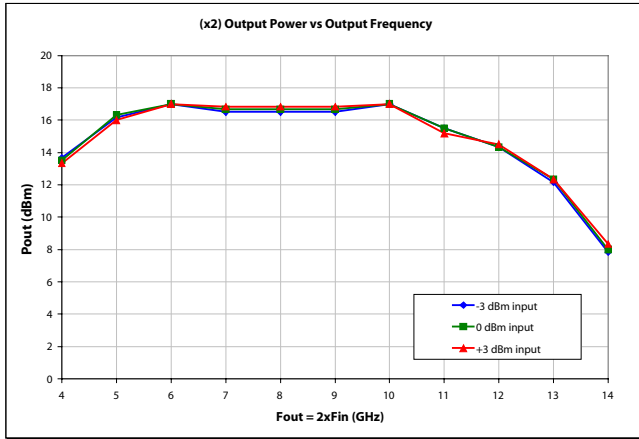

2.5-6.0/5.0-12.0 GHz Active Doubler QFN, 4x4 mm

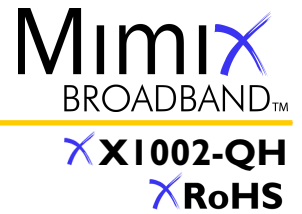

March 2006 - Rev 24-Mar-06

Doubler Measurements (cont.)

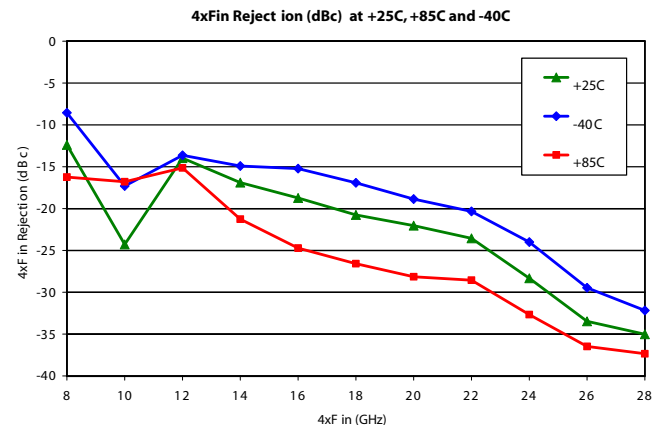
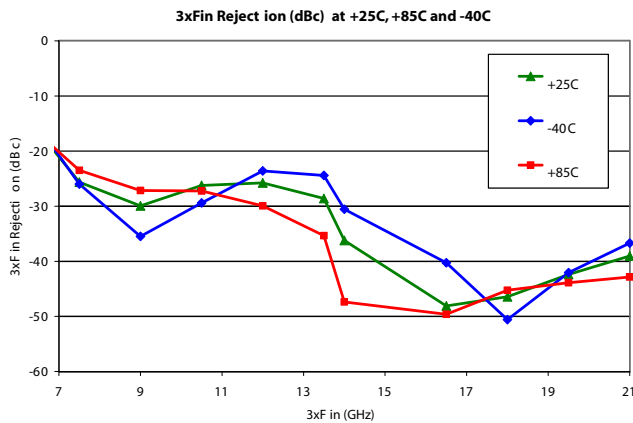
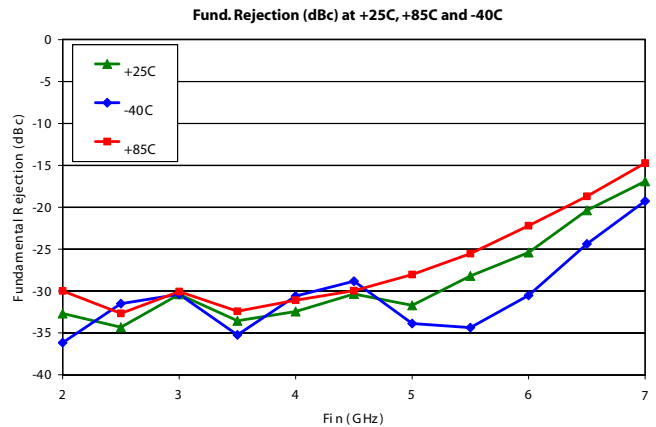
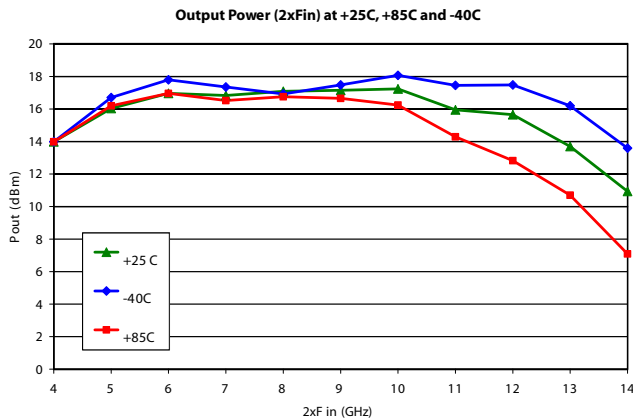
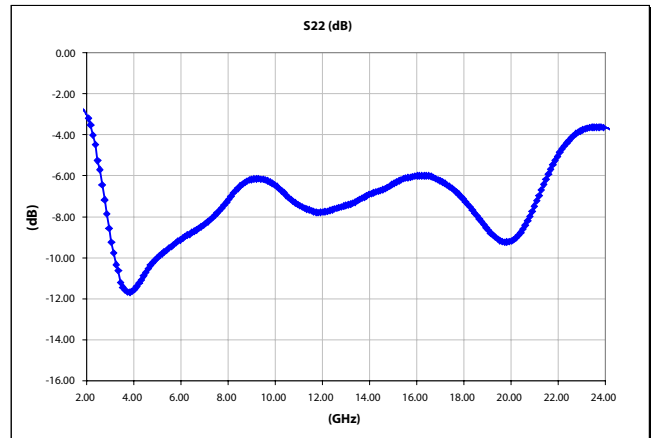
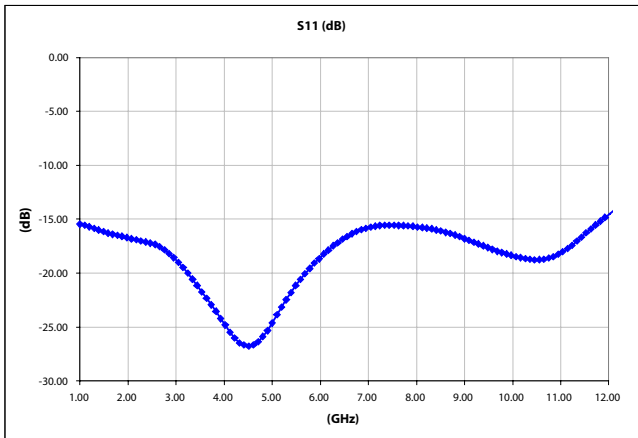

2.5-6.0/5.0-12.0 GHz Active Doubler QFN, 4x4 mm

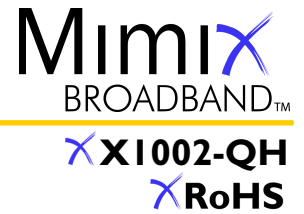

March 2006 - Rev 24-Mar-06

Package Outline

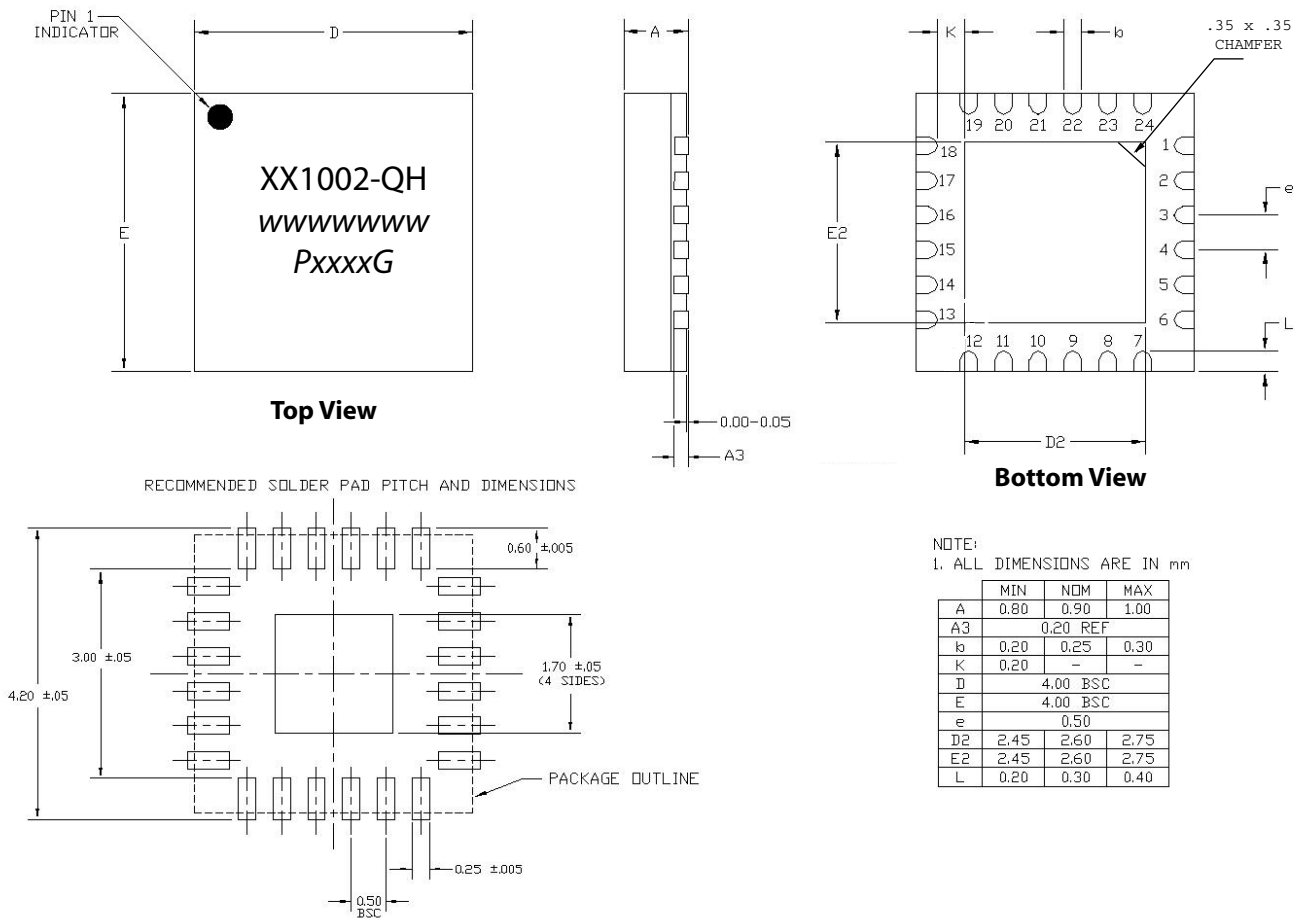

(Note: Engineering designator is 5DBL0644QH)

Units: millimeters

2.5-6.0/5.0-12.0 GHz Active Doubler QFN, 4x4 mm

March 2006 - Rev 24-Mar-06

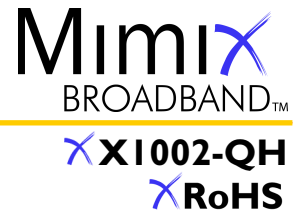

PCB Layout

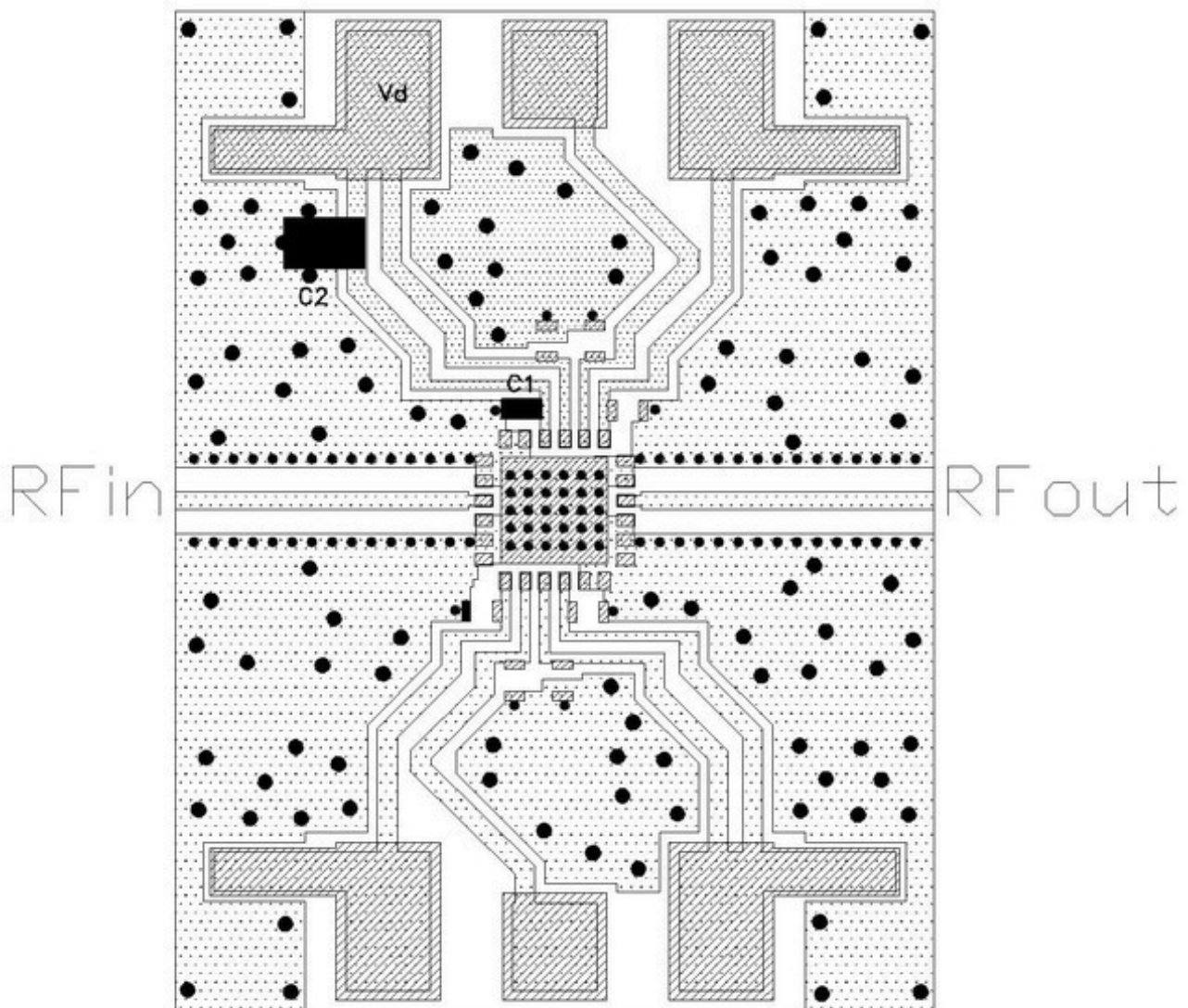

C1: 1000pF

C2: 1uF

2.5-6.0/5.0-12.0 GHz Active Doubler QFN, 4x4 mm



March 2006 - Rev 24-Mar-06

XI002-QH
RoHS

App Note [1] Biasing - As shown in the bonding diagram, this device is operated by biasing Vcc with Vcc=5.0 V and Icc=125 mA.

App Note [2] Bias Arrangement - The DC pad (Vcc) needs to have DC bypass capacitance. (~100 - 200 pF) as close to the device as possible.

MTTF Tables

These numbers were calculated based on accelerated life test information and thermal model analysis received from the fabricating foundry.

Backplate Temperature	MTTF Hours	FITs
55 deg Celsius	2.67E+06	375
75 deg Celsius	3.01E+05	3321
95 deg Celsius	4.46E+04	22440

Bias Conditions: Vcc=5.0V, Icc=125 mA

Functional Schematic

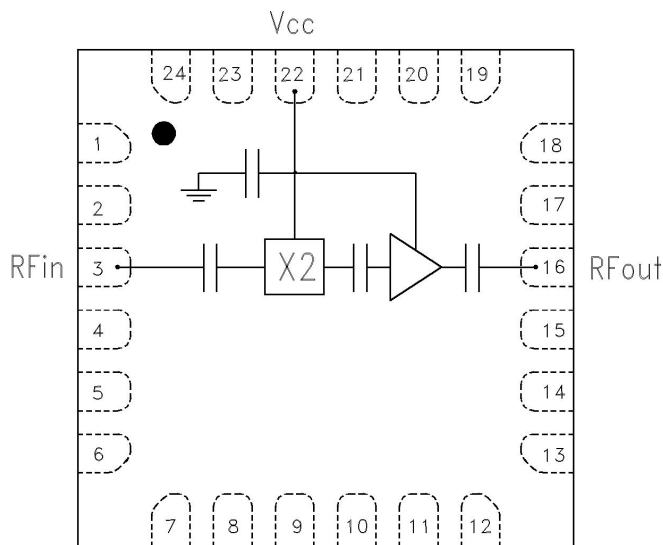

TOP VIEW

Pin	Description
3	RF In
16	RF Out
22	Vcc

All Other Pins - N/C

2.5-6.0/5.0-12.0 GHz Active Doubler QFN, 4x4 mm

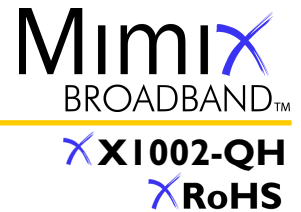

March 2006 - Rev 24-Mar-06

Handling and Assembly Information

CAUTION! - Mimix Broadband MMIC Products contain gallium arsenide (GaAs) which can be hazardous to the human body and the environment. For safety, observe the following procedures:

- Do not ingest.
- Do not alter the form of this product into a gas, powder, or liquid through burning, crushing, or chemical processing as these by-products are dangerous to the human body if inhaled, ingested, or swallowed.
- Observe government laws and company regulations when discarding this product. This product must be discarded in accordance with methods specified by applicable hazardous waste procedures.

Life Support Policy - Mimix Broadband's products are not authorized for use as critical components in life support devices or systems without the express written approval of the President and General Counsel of Mimix Broadband. As used herein: (1) Life support devices or systems are devices or systems which, (a) are intended for surgical implant into the body, or (b) support or sustain life, and whose failure to perform when properly used in accordance with instructions for use provided in the labeling, can be reasonably expected to result in a significant injury to the user. (2) A critical component is any component of a life support device or system whose failure to perform can be reasonably expected to cause the failure of the life support device or system, or to affect its safety or effectiveness.

Package Attachment - This packaged product from Mimix Broadband is provided as a rugged surface mount package compatible with high volume solder installation. The package is a low-cost plastic package. Vacuum tools or other suitable pick and place equipment may be used to pick and place this part. Care should be taken to ensure that there are no voids or gaps in the solder connection so that good RF, DC and ground connections are maintained. Voids or gaps can eventually lead not only to RF performance degradation, but reduced reliability and life of the product due to thermal stress.

Typical Reflow Profiles

Reflow Profile	SnPb	Pb Free
Ramp Up Rate	3-4 °C/sec	3-4 °C/sec
Activation Time and Temperature	60-120 sec @ 140-160 °C	60-180 sec @ 170-200 °C
Time Above Melting Point	60-150 sec	60-150 sec
Max Peak Temperature	240 °C	265 °C
Time Within 5 °C of Peak	10-20 sec	10-20 sec
Ramp Down Rate	4-6 °C/sec	4-6 °C/sec

Mimix Lead-Free RoHS Compliant Program - Mimix has an active program in place to meet customer and governmental requirements for eliminating lead (Pb) and other environmentally hazardous materials from our products. All Mimix RoHS compliant components are form, fit and functional replacements for their non-RoHS equivalents. Lead plating of our RoHS compliant parts is 100% matt tin (Sn) over copper alloy and is backwards compatible with current standard SnPb low-temperature reflow processes as well as higher temperature (260°C reflow) "Pb Free" processes.

Part Number for Ordering

XX1002-QH-0G00

XX1002-QH-0G0T

PB-XX1002-QH-0000

Description

Matte Tin plated RoHS compliant QFN 4x4 24L surface mount package in bulk quantity

Matte Tin plated RoHS compliant QFN 4x4 24L surface mount package in tape and reel

XX1002-QH Evaluation Board

We also offer this part with SnPb (Tin-Lead) or NiPdAu plating. Please contact your regional sales manager for more information regarding different plating types.