

5.8-16GHz Low Noise Amplifier

GaAs Monolithic Microwave IC in hermetic package

Description

The CHA3666-SNF is a two-stage self-biased wide band monolithic low noise amplifier.

The circuit is manufactured with a standard P-HEMT process: 0.25 μ m gate length, via holes through the substrate, air bridges and electron beam gate lithography.

It is supplied in lead-free, hermetic package compatible for space application.

Preliminary

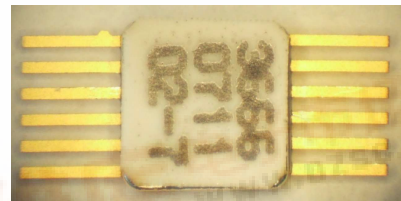

Main Features

- Broadband performance 5.8-16GHz
- 2.8dB maximum noise figure
- 24dBm 3rd order intercept point
- 16dBm power at 1dB compression
- 20dB gain
- Low DC power consumption
- 12L-Glass/metal hermetic package

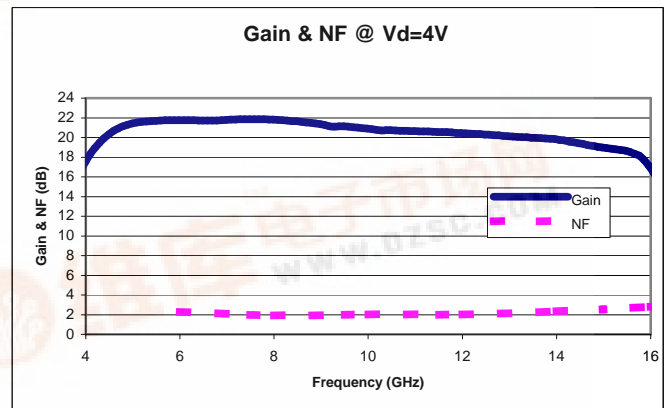

Main Characteristics

Tamb = +25 $^{\circ}$ C, Vd = +4V, Id=80mA

Symbol	Parameter	Min	Typ	Max	Unit
NF	Noise figure		2.1	2.8	dB
G	Smal signal Gain	16	20		dB
IP3	3rd order intercept point		24		dBm

ESD Protections : Electrostatic discharge sensitive device observe handling precautions!

Electrical Characteristics

Temp = +25°C, Vd=4V (1)

Symbol	Parameter	Min	Typ	Max	Unit
Fop	Operating frequency range	5.8		16	GHz
G	Gain	16	20		dB
ΔG	Gain flatness		± 1		dB
NF	Noise figure		2.1	2.8	dB
IS11I	Input return loss		2.3:1	3:1	
IS22I	Output return loss		1.9:1	2.5:1	
IP3	3rd order intercept point		24		dBm
P1dB	Output power at 1dB gain comp	14.5	16		dBm
Vd	Drain bias voltage		4		V
Id	Drain bias current	60	80	100	mA

(1) These values are representative of on board measurements as defined on the drawing 96446 (see below).

Absolute Maximum Ratings (1)

Temp = +25°C

Symbol	Parameter	Values	Unit
Vd	Drain bias voltage	4.5	V
Pin	RF input power	10	dBm
Top	Operating temperature range (2)	-40 to +85	°C
Tj	Junction temperature (3)	175	°C
Tstg	Storage temperature range	-55 to +125	°C

(1) Operation of this device above any of these parameters may cause permanent damage

(2) Top = Package Ground Paddle back side temperature

(3) Thermal Resistance channel to ground paddle = 214°C/W for Tground paddle = +85°C

Typical Package Sij parameters for low current configuration in 96446 board - in connector plane - Temp = +25°C, Vd= +4V , typical Id=80mA

F(GHz)	dBS11	PhS11(°)	dBS21	PhS21(°)	dBS12	PhS12(°)	dBS22	PhS22(°)	NF(dB)
0.1	-0.02	-12.36	-60.38	139.48	-64.76	-124.85	-0.03	-12.38	
1.0	-0.20	-120.14	-51.96	106.43	-66.83	84.74	-0.34	-120.02	
1.5	-0.39	-177.23	-48.22	-127.20	-75.55	124.32	-0.77	-176.02	
2.0	-0.64	123.96	-24.00	167.40	-68.76	-7.25	-1.69	130.69	
2.5	-0.98	57.81	-14.91	110.27	-59.27	-25.95	-1.37	74.27	
3.0	-1.57	-21.16	2.92	44.44	-57.06	-110.13	-2.84	-3.77	
3.5	-2.43	-110.87	12.31	-67.44	-66.93	153.56	-6.78	-71.82	
4.0	-4.34	154.20	17.54	-172.21	-59.56	-102.75	-9.70	-124.50	
4.5	-8.12	54.55	20.34	89.22	-48.72	172.09	-11.01	-165.12	
5.0	-11.16	-52.92	21.42	-1.47	-44.68	96.06	-11.04	153.87	
5.5	-10.35	-138.28	21.70	-83.26	-43.11	23.69	-11.58	110.50	
6.0	-9.06	161.41	21.76	-159.03	-41.87	-42.92	-12.71	65.18	2.263
6.5	-8.66	111.23	21.72	129.68	-41.28	-105.13	-14.26	11.83	
7.0	-9.03	65.00	21.79	61.19	-40.42	-164.80	-16.11	-62.21	
7.5	-10.14	17.00	21.85	-6.81	-39.54	131.57	-16.10	-149.55	
8.0	-12.21	-34.04	21.81	-73.75	-39.48	67.94	-13.34	133.51	1.929
8.5	-14.28	-97.49	21.67	-139.41	-39.49	7.97	-11.71	74.57	
9.0	-14.46	-177.11	21.35	155.94	-39.32	-51.71	-10.50	25.06	
9.5	-11.85	115.71	21.14	93.78	-38.14	-111.12	-10.61	-21.62	
10.0	-9.69	55.02	20.92	31.53	-38.25	-168.04	-10.53	-64.86	2.016
10.5	-9.00	2.05	20.74	-29.49	-37.65	133.49	-11.26	-109.97	
11.0	-9.36	-50.93	20.64	-90.59	-37.24	78.04	-12.62	-160.01	
11.5	-10.99	-107.09	20.57	-151.94	-36.71	19.74	-14.09	145.24	
12.0	-12.72	-174.74	20.45	146.68	-36.63	-39.71	-14.50	86.87	2.026
12.5	-12.50	110.72	20.31	85.40	-36.74	-98.01	-13.20	31.84	
13.0	-10.35	48.31	20.14	24.29	-36.68	-153.72	-11.87	-17.92	
13.5	-8.87	-4.04	19.98	-36.89	-36.98	149.45	-10.88	-63.55	
14.0	-8.70	-47.93	19.82	-98.74	-36.97	93.10	-11.28	-108.47	2.33
14.5	-9.89	-87.63	19.42	-160.87	-36.83	36.08	-12.37	-154.57	
15.0	-11.55	-117.88	18.99	138.15	-36.64	-19.54	-16.65	149.97	
15.5	-12.35	-149.85	18.67	75.82	-35.86	-77.12	-35.87	84.18	
16.0	-10.37	165.68	17.13	10.79	-34.33	-150.29	-14.27	-163.03	2.809
16.5	-7.75	69.16	16.68	-24.68	-43.15	114.42	-10.90	82.97	
17.0	-9.93	3.68	18.88	-98.63	-43.49	134.87	-15.99	65.62	
17.5	-9.39	-43.54	17.96	-166.15	-38.62	98.95	-11.57	36.49	
18.0	-8.11	-93.30	17.52	132.71	-34.16	37.05	-8.63	-13.07	3.607
18.5	-9.91	-155.23	17.16	68.45	-31.76	-32.73	-8.10	-70.38	
19.0	-12.43	127.43	16.80	3.23	-31.36	-105.37	-11.09	-126.69	
19.5	-11.75	15.00	15.77	-67.74	-32.93	-168.03	-15.17	-179.57	
20.0	-9.90	-67.91	13.59	-133.13	-31.81	140.77	-15.84	102.41	

Typical Measured Performance

Temp = +25°C, Vd=4V (Id=80mA)

Measurements in the connector planes, using the proposed land pattern & board 96446.

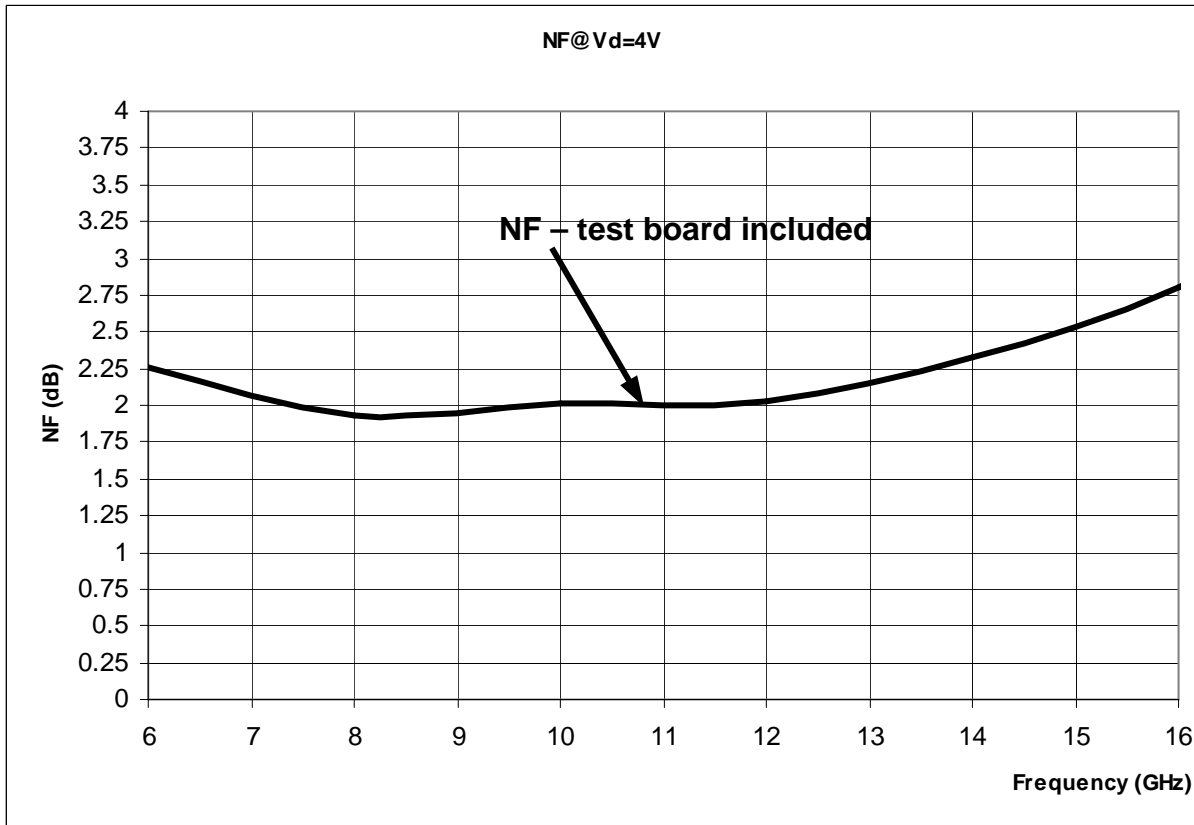
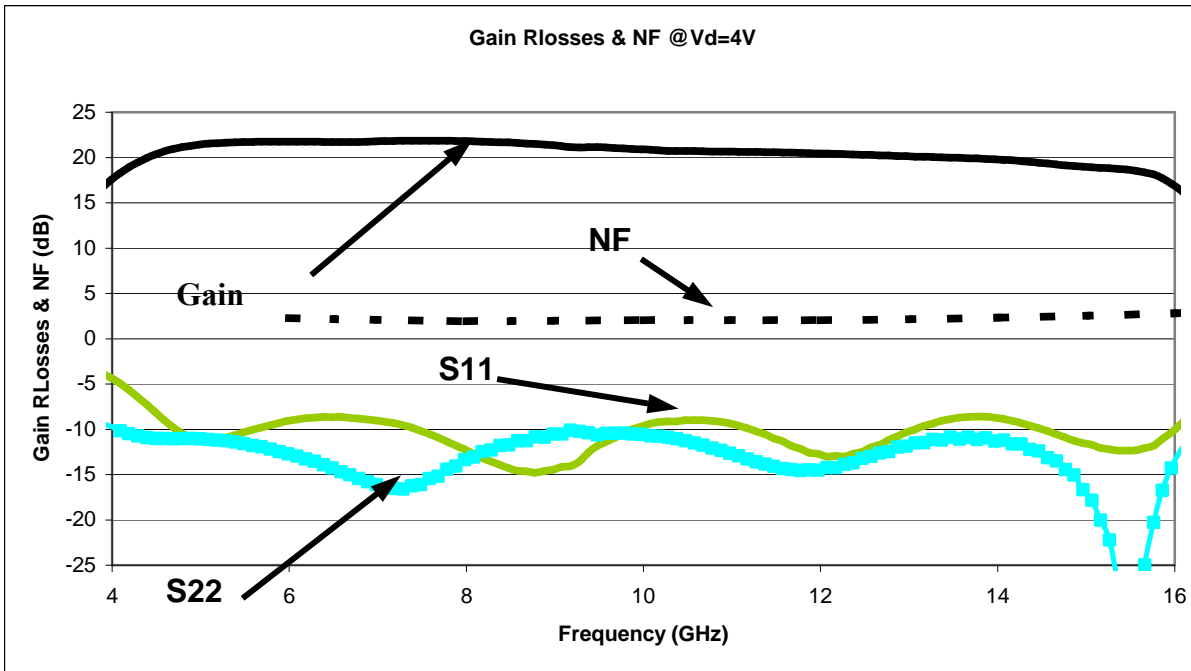

Output power at 1dB compression versus frequency

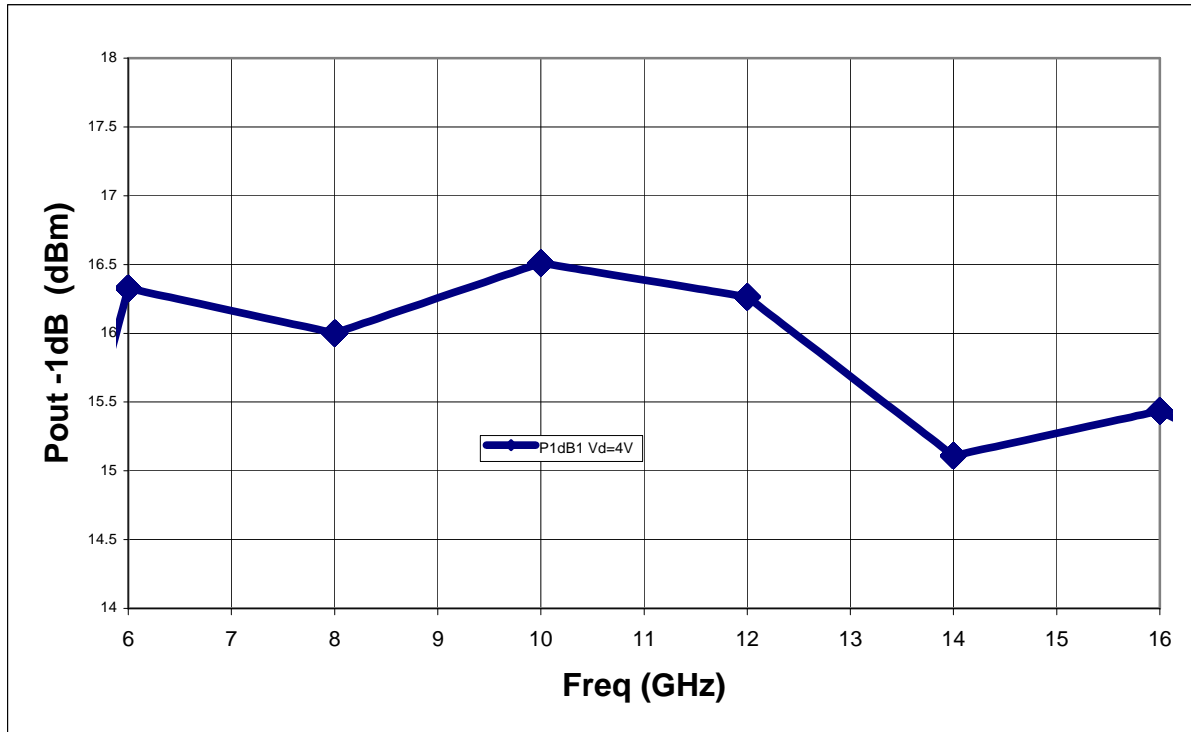

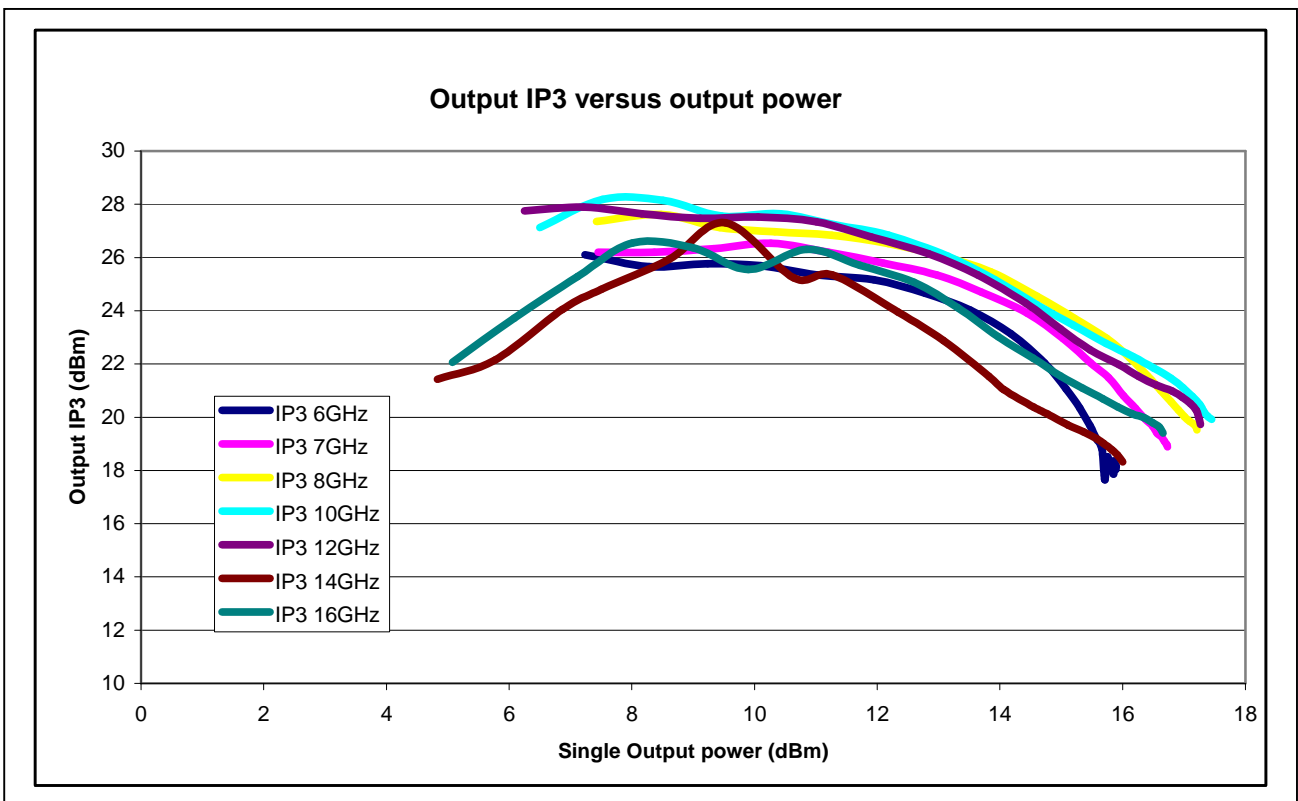
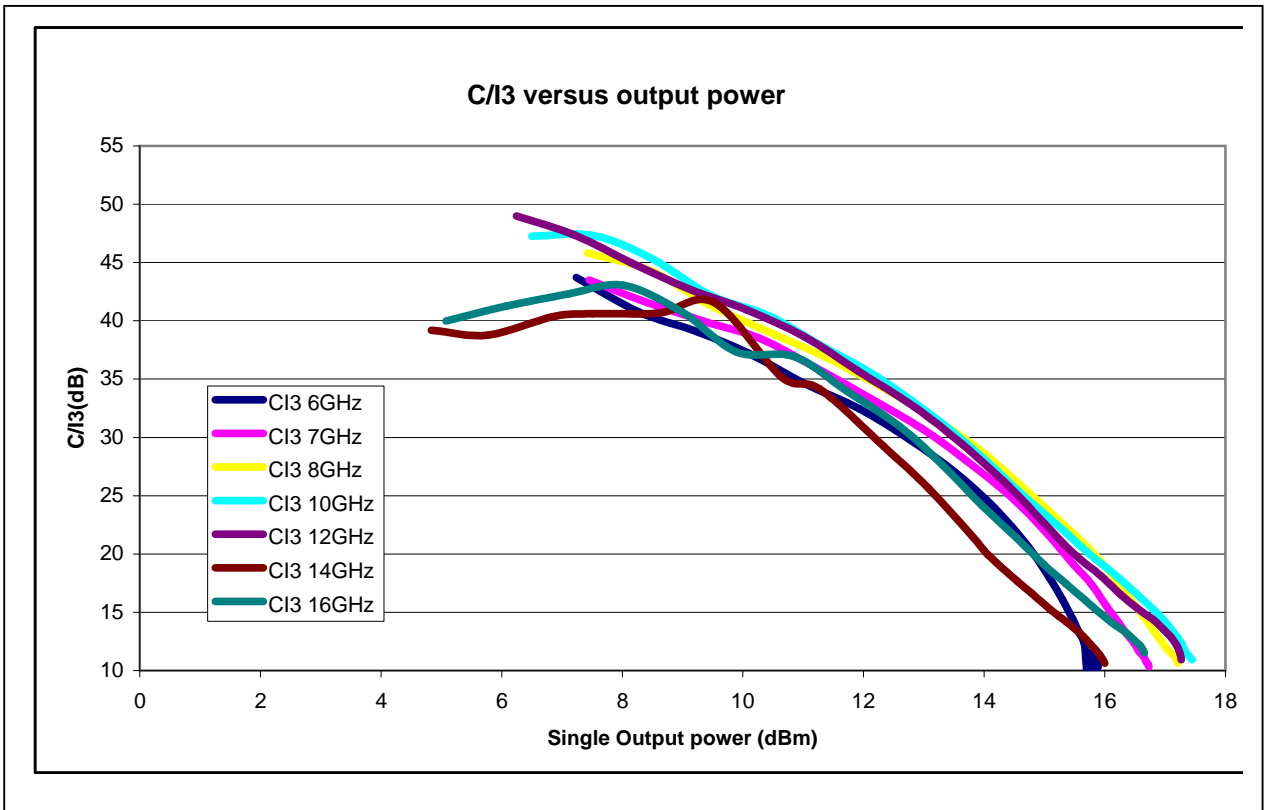

Package outline (dim. mm):

Units : mm

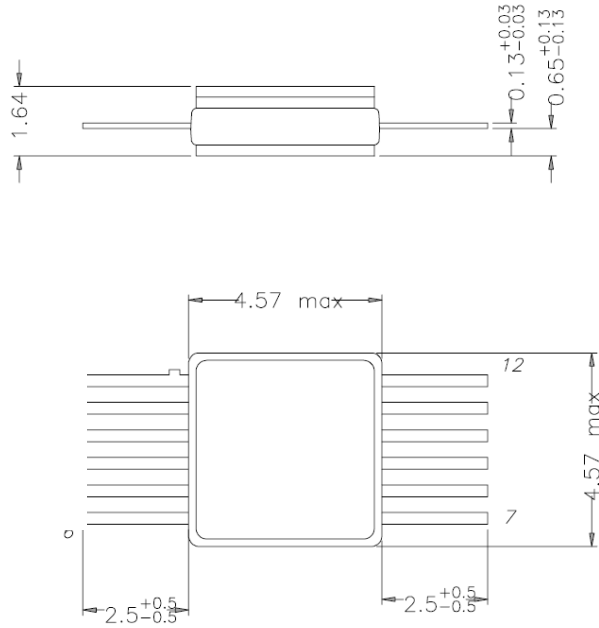

- 1- Gnd 7- Gnd
- 2- VD1-VD2- RF OUT
- 3- Gnd 9- Gnd
- 4- Gnd 10- Cnd
- 5- RF IN 11- VD1-VD2
- 6- Gnd 12- Gnd

(*) Pin 2 and 11 should be chosen alternatively

CHA3666-SNF

5.8-16GHz Low Noise Amplifier

Proposed Assembly board "96446" for the 12L-GlassMetal package products characterization.

- Compatible with the proposed footprint.
- Based on typically Ro4003 / 8mils or equivalent.
- Using a microstrip to coplanar transition to access the package.
- Two biasing side options (pin 2 and 11) – decoupling capacitance 10nF.
- Recommended for the implementation of this product on a module board.

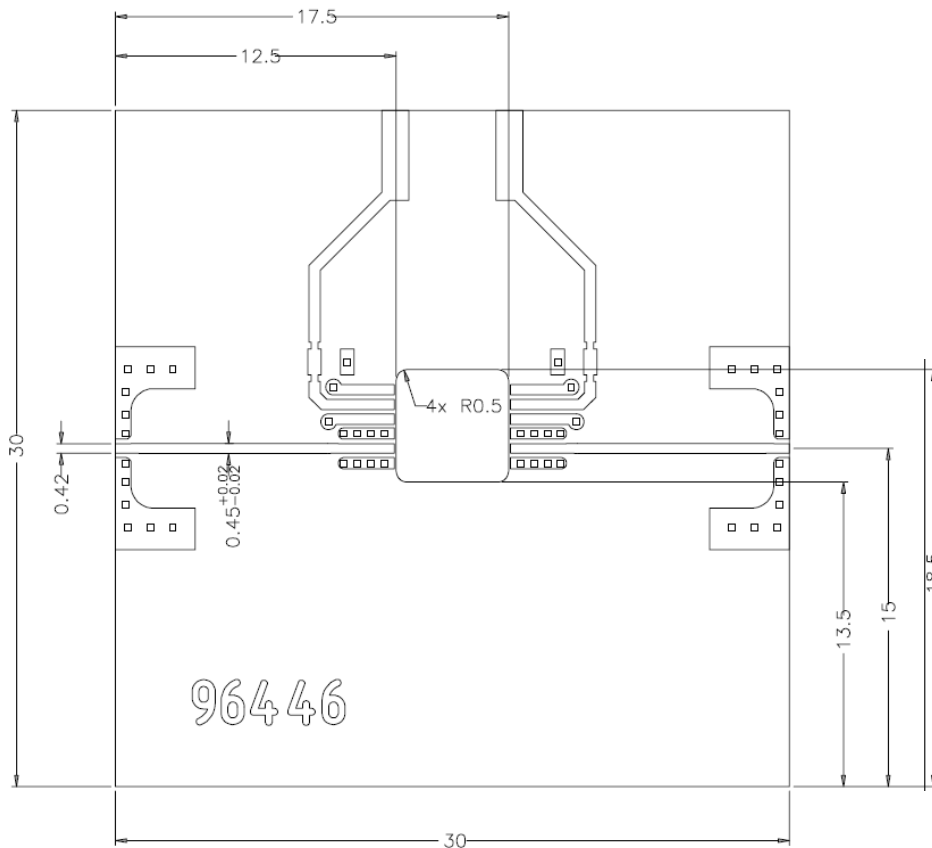

MATIERE
Ro4003 ROGERS
Epaisseur : 0,008 in (0.203 mm)
2 faces Cu 17,5?m

PER?AGE TROUS METAL.
□ 32 ° 0.3 fini 0.2

Package Biasing options

This chip is self-biased, and flexibility is provided by the access to number of leads. The internal DC electrical schematic is given in order to use these leads in a safe way.

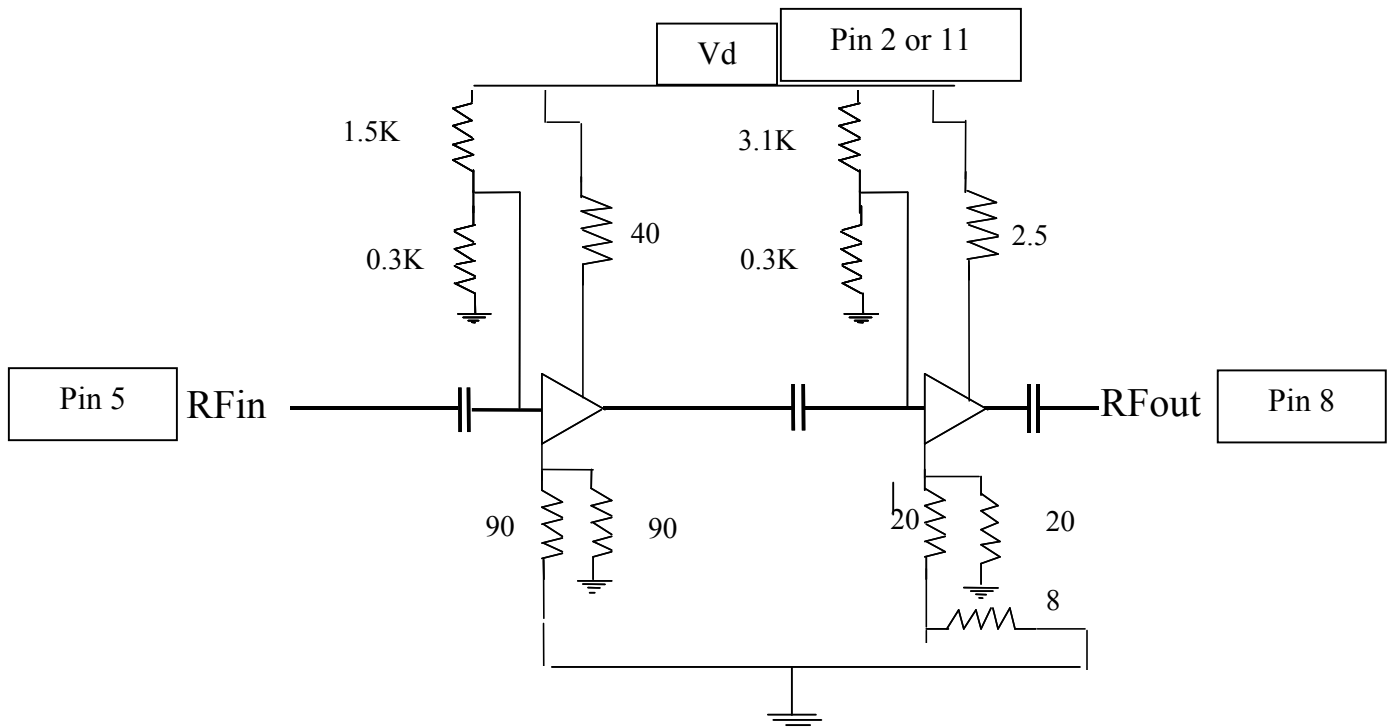

Standard biasing:

Low Noise and low consumption:

$V_d = 4V$

$I_{dd} = 80mA$ & $P_{out-1dB} = 16dBm$ Typical.

Ordering Information

Glass/Metal 12L RoHS compliant hermetic package: CHA3666-SNF/XY
Tray: XY = 20

Information furnished is believed to be accurate and reliable. However **United Monolithic Semiconductors S.A.S.** assumes no responsibility for the consequences of use of such information nor for any infringement of patents or other rights of third parties which may result from its use. No license is granted by implication or otherwise under any patent or patent rights of **United Monolithic Semiconductors S.A.S.**. Specifications mentioned in this publication are subject to change without notice. This publication supersedes and replaces all information previously supplied. **United Monolithic Semiconductors S.A.S.** products are not authorised for use as critical components in life support devices or systems without express written approval from **United Monolithic Semiconductors S.A.S.**