



# CMT01N60

## POWER FIELD EFFECT TRANSISTOR

### GENERAL DESCRIPTION

This high voltage MOSFET uses an advanced termination scheme to provide enhanced voltage-blocking capability without degrading performance over time. In addition, this advanced MOSFET is designed to withstand high energy in avalanche and commutation modes. The new energy efficient design also offers a drain-to-source diode with a fast recovery time. Designed for high voltage, high speed switching applications in power supplies, converters and PWM motor controls, these devices are particularly well suited for bridge circuits where diode speed and commutating safe operating areas are critical and offer additional and safety margin against unexpected voltage transients.

### FEATURES

- ◆ Robust High Voltage Termination
- ◆ Avalanche Energy Specified
- ◆ Source-to-Drain Diode Recovery Time Comparable to a Discrete Fast Recovery Diode
- ◆ Diode is Characterized for Use in Bridge Circuits
- ◆  $I_{DSS}$  and  $V_{DS(on)}$  Specified at Elevated Temperature

### PIN CONFIGURATION

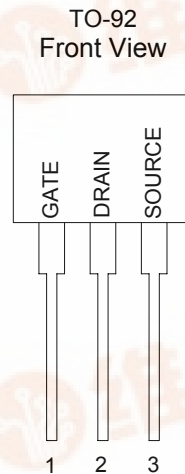
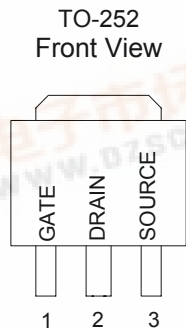
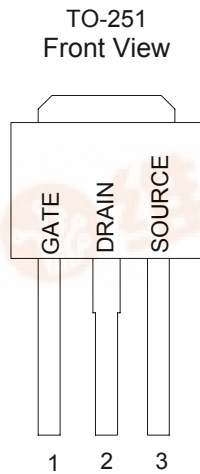

### SYMBOL

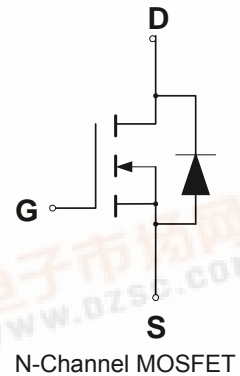

### ABSOLUTE MAXIMUM RATINGS

Rating	Symbol	Value	Unit
Drain to Current – Continuous	$I_D$	1.0	A
– Pulsed	$I_{DM}$	9.0	A
Gate-to-Source Voltage – Continue	$V_{GS}$	$\pm 30$	V
– Non-repetitive	$V_{GSM}$	$\pm 40$	V
Total Power Dissipation TO-251/252	$P_D$	50	W
Operating and Storage Temperature Range	$T_J, T_{STG}$	-55 to 150	$^{\circ}C$
Single Pulse Drain-to-Source Avalanche Energy – $T_J = 25^{\circ}C$ ( $V_{DD} = 100V, V_{GS} = 10V, I_{AS} = 2A, L = 10mH, R_G = 25\Omega$ )	$E_{AS}$	20	mJ
Thermal Resistance – Junction to Case	$\theta_{JC}$	1.0	$^{\circ}C/W$
– Junction to Ambient	$\theta_{JA}$	62.5	$^{\circ}C/W$
Maximum Lead Temperature for Soldering Purposes, 1/8" from case for 10 seconds	$T_L$	260	$^{\circ}C$





# CMT01N60

## POWER FIELD EFFECT TRANSISTOR

### ORDERING INFORMATION

Part Number	Package
CMT01N60N251	TO-251
CMT01N60N252	TO-252
CMT01N60N92	TO-92
CMT01N60GN251*	TO-251
CMT01N60GN252*	TO-252
CMT01N60GN92*	TO-92

\*Note: G : Suffix for Pb Free Product

### ELECTRICAL CHARACTERISTICS

Unless otherwise specified,  $T_J = 25^\circ\text{C}$ .

Characteristic		Symbol	CMT01N60			Units
			Min	Typ	Max	
Drain-Source Breakdown Voltage ( $V_{GS} = 0\text{ V}$ , $I_D = 250\ \mu\text{A}$ )		$V_{(BR)DSS}$	600			V
Drain-Source Leakage Current ( $V_{DS} = 600\text{ V}$ , $V_{GS} = 0\text{ V}$ ) ( $V_{DS} = 480\text{ V}$ , $V_{GS} = 0\text{ V}$ , $T_J = 125^\circ\text{C}$ )		$I_{DSS}$			0.1 0.3	mA
Gate-Source Leakage Current-Forward ( $V_{gsf} = 20\text{ V}$ , $V_{DS} = 0\text{ V}$ )		$I_{GSSF}$			100	nA
Gate-Source Leakage Current-Reverse ( $V_{gsr} = 20\text{ V}$ , $V_{DS} = 0\text{ V}$ )		$I_{GSSR}$			100	nA
Gate Threshold Voltage ( $V_{DS} = V_{GS}$ , $I_D = 250\ \mu\text{A}$ )		$V_{GS(th)}$	2.0		4.0	V
Static Drain-Source On-Resistance ( $V_{GS} = 10\text{ V}$ , $I_D = 0.6\text{A}$ ) *		$R_{DS(on)}$			8.0	$\Omega$
Forward Transconductance ( $V_{DS} \geq 50\text{ V}$ , $I_D = 0.5\text{A}$ ) *		$g_{FS}$	0.5			mhos
Input Capacitance	$(V_{DS} = 25\text{ V}$ , $V_{GS} = 0\text{ V}$ , $f = 1.0\text{ MHz}$ )	$C_{iss}$		210		pF
Output Capacitance		$C_{oss}$		28		pF
Reverse Transfer Capacitance		$C_{rss}$		4.2		pF
Turn-On Delay Time	$(V_{DD} = 300\text{ V}$ , $I_D = 1.0\text{ A}$ , $V_{GS} = 10\text{ V}$ , $R_G = 18\Omega$ ) *	$t_{d(on)}$		8		ns
Rise Time		$t_r$		21		ns
Turn-Off Delay Time		$t_{d(off)}$		18		ns
Fall Time		$t_f$		24		ns
Total Gate Charge	$(V_{DS} = 400\text{ V}$ , $I_D = 1.0\text{ A}$ , $V_{GS} = 10\text{ V}$ ) *	$Q_g$		8.5	14	nC
Gate-Source Charge		$Q_{gs}$		1.8		nC
Gate-Drain Charge		$Q_{gd}$		4		nC
Internal Drain Inductance (Measured from the drain lead 0.25" from package to center of die)		$L_D$		4.5		nH
Internal Drain Inductance (Measured from the source lead 0.25" from package to source bond pad)		$L_S$		7.5		nH
<b>SOURCE-DRAIN DIODE CHARACTERISTICS</b>						
Forward On-Voltage(1)	$(I_S = 1.0\text{ A}$ , $V_{GS} = 0\text{ V}$ , $d_i/d_t = 100\text{A}/\mu\text{s}$ )	$V_{SD}$			1.5	V
Forward Turn-On Time		$t_{on}$		**		ns
Reverse Recovery Time		$t_{rr}$		350	500	ns

\* Pulse Test: Pulse Width  $\leq 300\mu\text{s}$ , Duty Cycle  $\leq 2\%$

\*\* Negligible, Dominated by circuit inductance

### TYPICAL ELECTRICAL CHARACTERISTICS

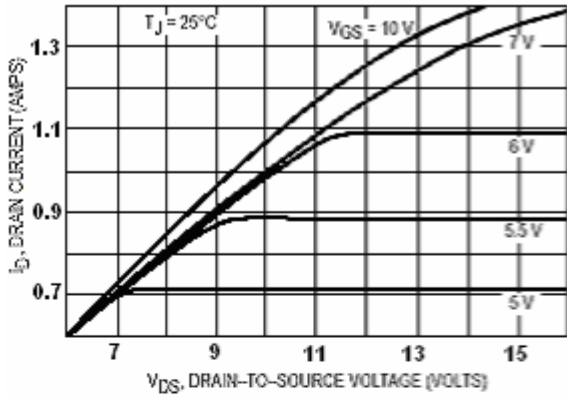

Figure 1. On-Region Characteristics

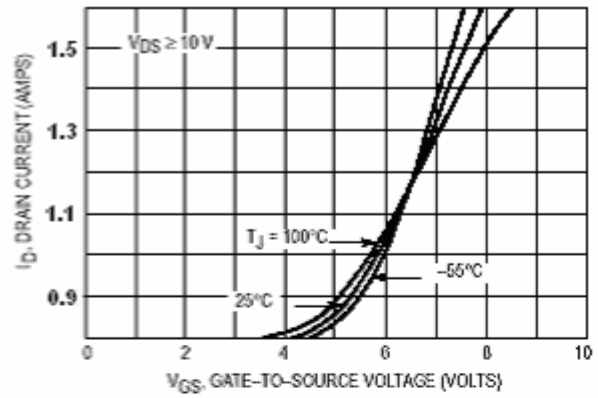

Figure 2. Transfer Characteristics

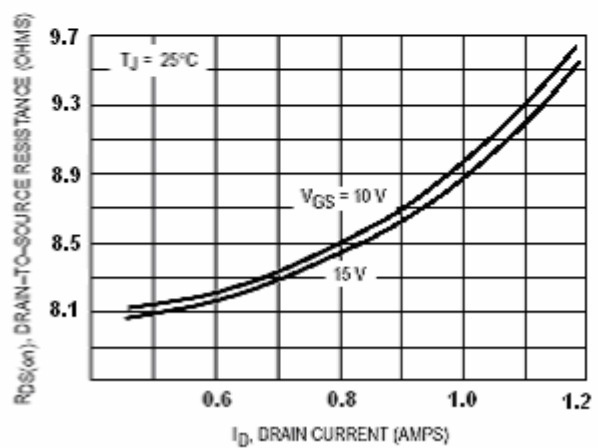
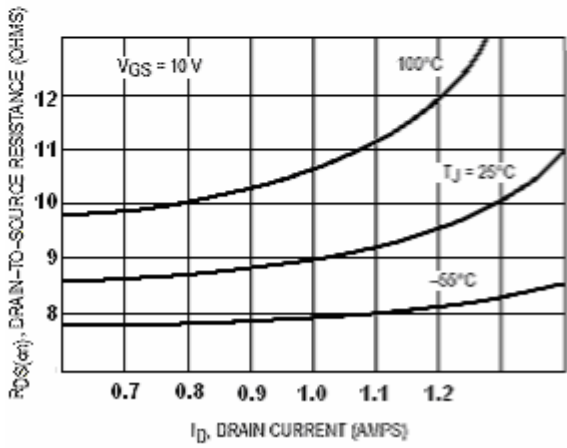

Figure 3. On-Resistance versus Drain Current and Temperature

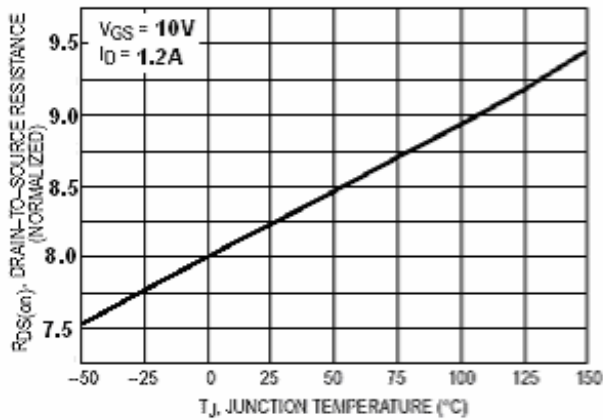

Figure 4. On-Resistance versus Drain Current and Gate Voltage

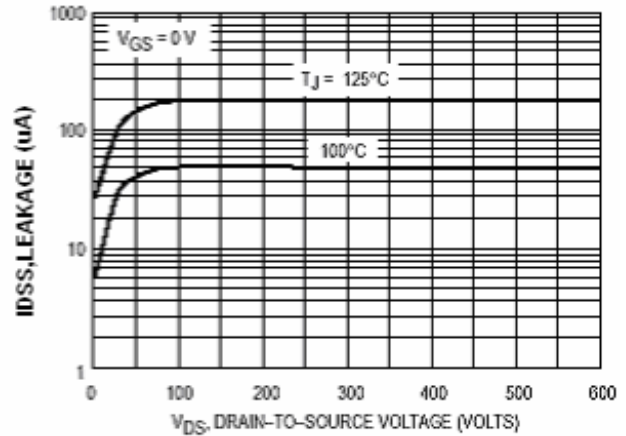
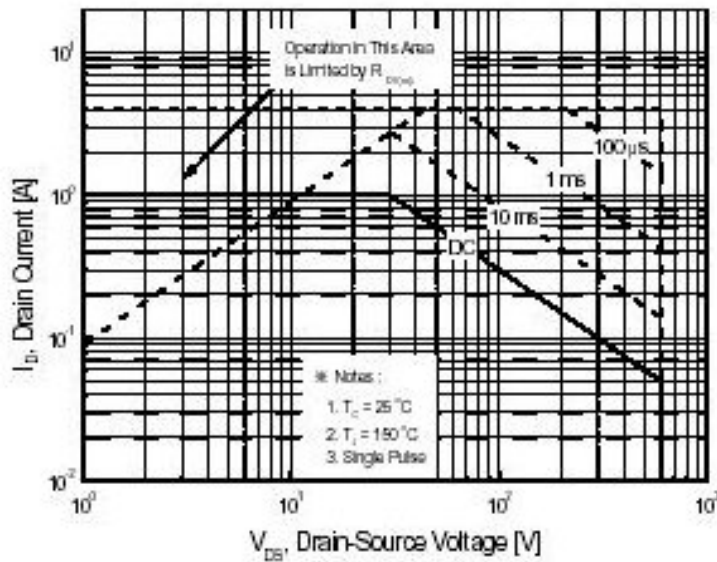

Figure 5. On-Resistance Variation with Temperature

Figure 6. Drain-To-Source Leakage Current versus Voltage



### Maximum Safe Operating Area

**PACKAGE DIMENSION**

TO-251

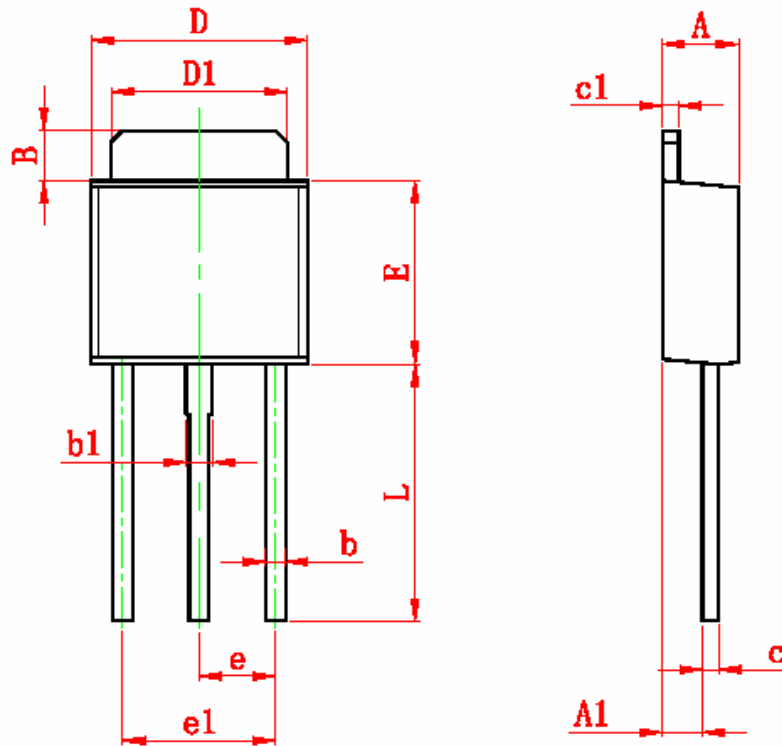

Symbol	Dimensions In Millimeters		Dimensions In Inches	
	Min	Max	Min	Max
A	2.200	2.400	0.087	0.094
A1	1.020	1.270	0.040	0.050
B	1.350	1.650	0.053	0.065
b	0.500	0.700	0.020	0.028
b1	0.700	0.900	0.028	0.035
c	0.430	0.580	0.017	0.023
c1	0.430	0.580	0.017	0.023
D	6.350	6.650	0.250	0.262
D1	5.200	5.400	0.205	0.213
E	5.400	5.700	0.213	0.224
e	2.300 TYP		0.091 TYP	
e1	4.500	4.700	0.177	0.185
L	7.500	7.900	0.295	0.311

**PACKAGE DIMENSION**

TO-252

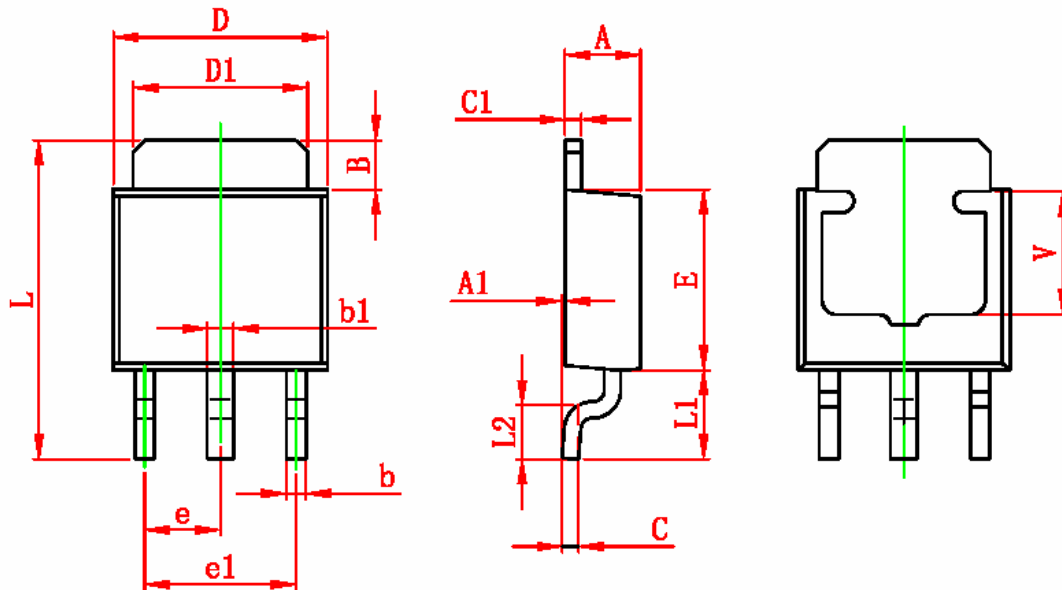

Symbol	Dimensions In Millimeters		Dimensions In Inches	
	Min	Max	Min	Max
A	2.200	2.400	0.087	0.094
A1	0.000	0.127	0.000	0.005
B	1.350	1.650	0.053	0.065
b	0.500	0.700	0.020	0.028
b1	0.700	0.900	0.028	0.035
c	0.430	0.580	0.017	0.023
c1	0.430	0.580	0.017	0.023
D	6.350	6.650	0.250	0.262
D1	5.200	5.400	0.205	0.213
E	5.400	5.700	0.213	0.224
e	2.300 TYP		0.091 TYP	
e1	4.500	4.700	0.177	0.185
L	9.500	9.900	0.374	0.390
L1	2.550	2.900	0.100	0.114
L2	1.400	1.780	0.055	0.070
V	3.80 REF		0.150 REF	

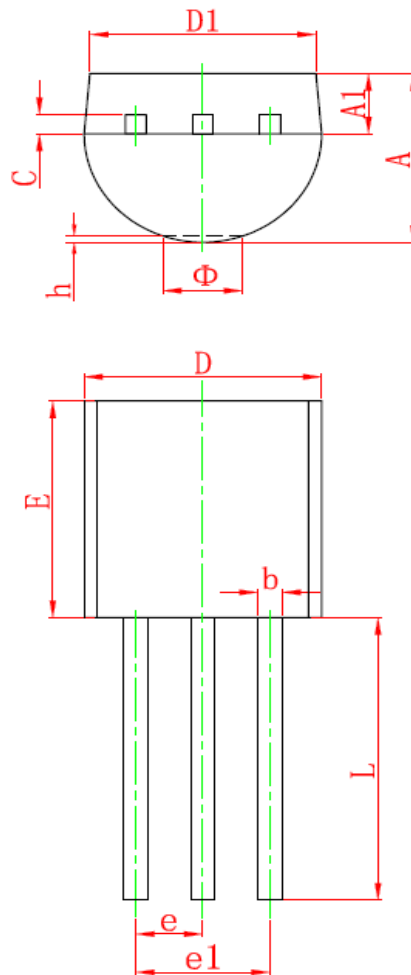
**TO-92 PACKAGE OUTLINE DIMENSIONS**

Symbol	Dimensions In Millimeters		Dimensions In Inches	
	Min	Max	Min	Max
A	3.300	3.700	0.130	0.146
A1	1.100	1.400	0.043	0.055
b	0.380	0.550	0.015	0.022
c	0.360	0.510	0.014	0.020
D	4.400	4.700	0.173	0.185
D1	3.430		0.135	
E	4.300	4.700	0.169	0.185
e	1.270 TYP		0.050 TYP	
e1	2.440	2.640	0.096	0.104
L	14.100	14.500	0.555	0.571
Φ		1.600		0.063
h	0.000	0.380	0.000	0.015



### IMPORTANT NOTICE

Champion Microelectronic Corporation (CMC) reserves the right to make changes to its products or to discontinue any integrated circuit product or service without notice, and advises its customers to obtain the latest version of relevant information to verify, before placing orders, that the information being relied on is current.

A few applications using integrated circuit products may involve potential risks of death, personal injury, or severe property or environmental damage. CMC integrated circuit products are not designed, intended, authorized, or warranted to be suitable for use in life-support applications, devices or systems or other critical applications. Use of CMC products in such applications is understood to be fully at the risk of the customer. In order to minimize risks associated with the customer's applications, the customer should provide adequate design and operating safeguards.

#### **HsinChu Headquarter**

---

5F-1, No. 11, Park Avenue II,  
Science-Based Industrial Park,  
HsinChu City, Taiwan  
TEL: +886-3-567 9979  
FAX: +886-3-567 9909

#### **Sales & Marketing**

---

11F, No. 306-3, SEC. 1, Ta Tung Road,  
Hsichih, Taipei Hsien 221, Taiwan  
TEL: +886-2-8692 1591  
FAX: +886-2-8692 1596

---