

Micropower Supply Voltage Supervisor (SVS)

Features

- Precision voltage sensor
- 4.0V trip threshold
- Stable over temperature
- Valid output logic while $V_{CC} = 0V$.
- Power-on reset pulse width of 140ms/min. to 560ms/max.
- Low quiescent current (40 μA typ.)
- No external components required
- 3-pin SOT23 package

Applications

- Critical μP and μC power monitoring
- PCI applications
- Memory integrity during "brown-outs"

Product Description

The CM3404 is a micropower low voltage supply supervisor designed to provide the necessary power-on reset control for microprocessors and memory applications. An internal pull-down resistor on the \overline{RESET} output ensures the output remains valid under all supply conditions.

During either a cold-start power-up or a complete power-down sequence, the \overline{RESET} output will remain at 0V while the V_{CC} input voltage is between the threshold level and ground.

When the V_{CC} input exceeds the preset threshold voltage, an internal timer is triggered and the \overline{RESET} output remains active for a minimum of 140ms, at which point the output is taken inactive.

In the event of a "brown-out" condition, the reset output is immediately asserted as soon as the V_{CC} voltage collapses below the threshold.

Both the trigger threshold and the precision delay pulse are internally controlled and do not require any external components.

Typical Application Circuit

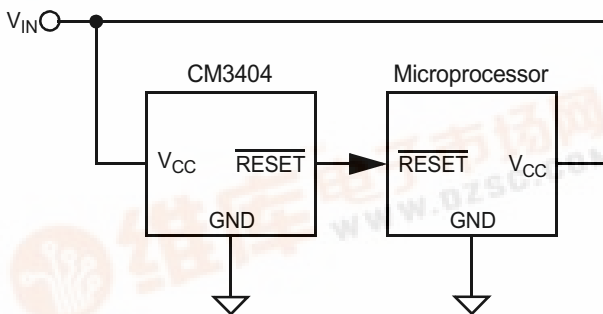

Simplified Electrical Schematic

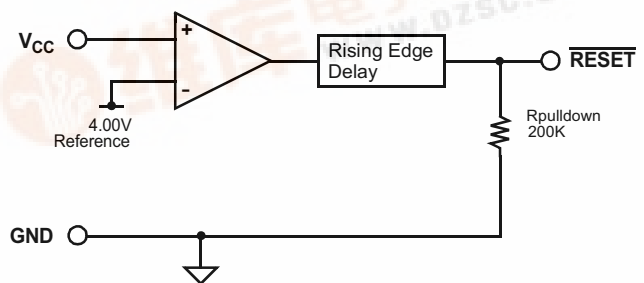



PACKAGE / PINOUT DIAGRAM

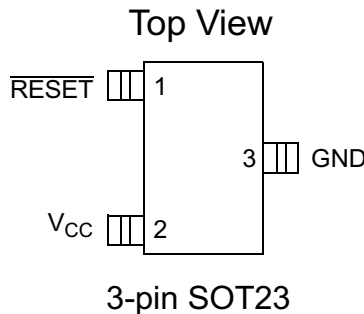

Note: This drawing is not to scale.

PIN DESCRIPTIONS

PIN(S)	NAME	DESCRIPTION
1	$\overline{\text{RESET}}$	Active low reset output. When the sense threshold has been exceeded, the $\overline{\text{RESET}}$ signal will remain active for an additional 140ms (min.) after which it is taken inactive. During a "brown-out" condition $\overline{\text{RESET}}$ will immediately be taken active. Internal circuitry ensures $\overline{\text{RESET}}$ will remain active even when the supply voltage is as low as 0V.
2	VCC	Supply input signal which is monitored by the sense comparator. This input is compared to the 4.00V reference to determine the state of the output.
3	GND	Negative reference for all signals.

Ordering Information

PART NUMBERING INFORMATION

Pins	Package	Ordering Part Number ²	Part Marking
3	SOT-23	CM3404-40ST	173Z

Note 1: Parts are shipped in Tape & Reel form unless otherwise specified.



Specifications

ABSOLUTE MAXIMUM RATINGS		
PARAMETER	RATING	UNITS
ESD Protection (HBM)	±1500	V
Pin Voltages		
V_{CC}	[GND - 0.5] to +6.5	V
\overline{RESET}	[GND - 0.5] to [V_{CC} + 0.5]	V
Storage Temperature Range	-40 to +150	°C
Operating Temperature Range Ambient	-40 to +125	°C

STANDARD OPERATING CONDITIONS		
PARAMETER	VALUE	UNITS
V_{CC}	0 to 6.0	V
Ambient Operating Temperature Range	0 to +70	°C

ELECTRICAL OPERATING CHARACTERISTICS ¹						
SYMBOL	PARAMETER	CONDITIONS	MIN	TYP	MAX	UNITS
V_{TH}	Sense Threshold	$T_A=25^\circ C$	3.93	4.00	4.06	V
			3.89	4.00	4.10	V
I_{CC}	Supply Current	No load.		40	80	µA
T_{DELAY}	Reset Timeout Delay		140		560	mS
t_{PHL}	Propagation Delay when asserting \overline{RESET}	$V_{CC} < (V_{TH} - 50mV)$		0.2	5	µS
$R_{PULLDOWN}$	\overline{RESET} Pull-Down Impedance	$V_{CC} < 1.5V$		200	500	kΩ
		$V_{CC} > 1.5V$		0.5	3	kΩ
R_{PULLUP}	\overline{RESET} Pull-Up Impedance			0.5	3	kΩ

Note 1: Electrical Operating Characteristics are specified over the Standard Operating Conditions unless specified otherwise.



Performance Information

CM3404 Typical Characteristics (nominal conditions unless specified otherwise)

Transient Operation Description

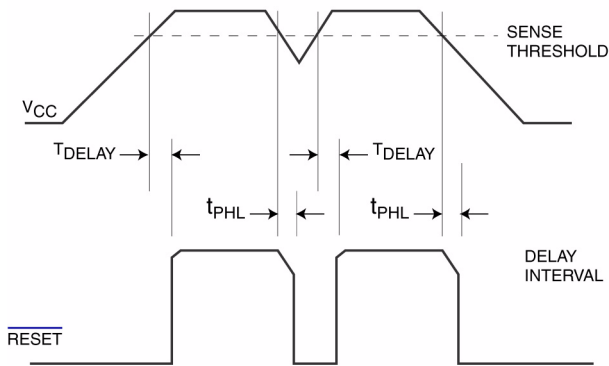

Power-up Reset Response

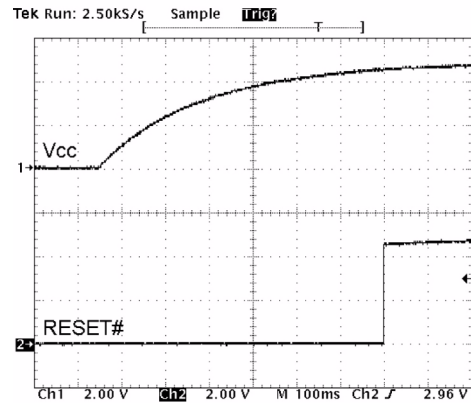

Reset Response with Overdrive

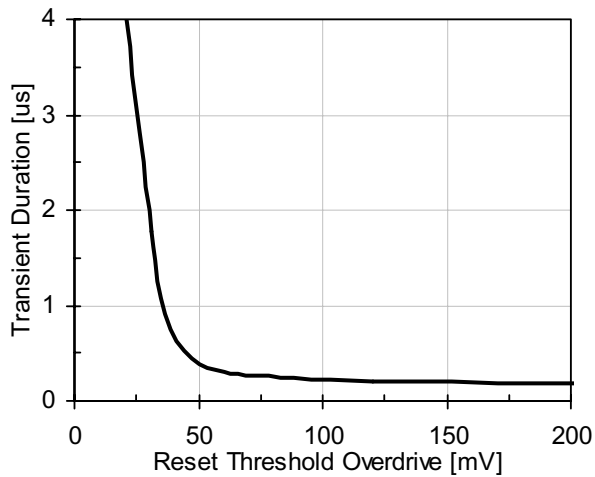

Ground Current vs. Voltage

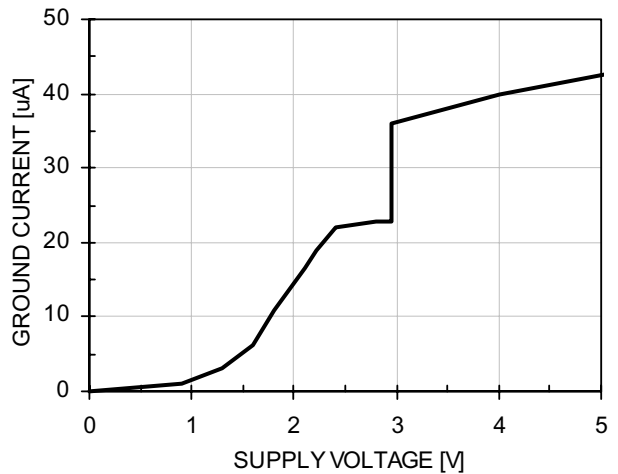

Below Trigger RESET* Pull-down

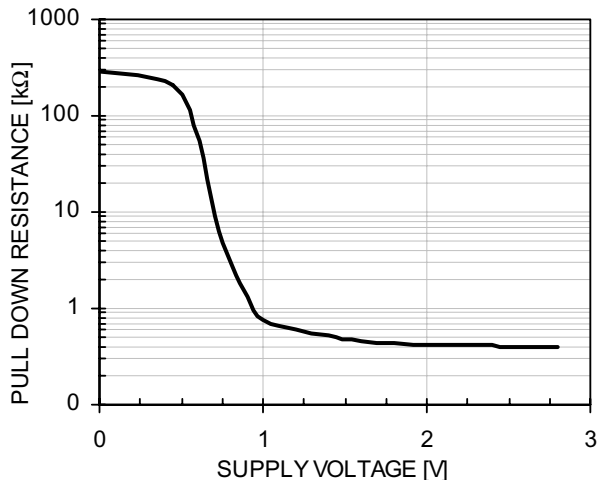

Above Trigger RESET* Pull-up

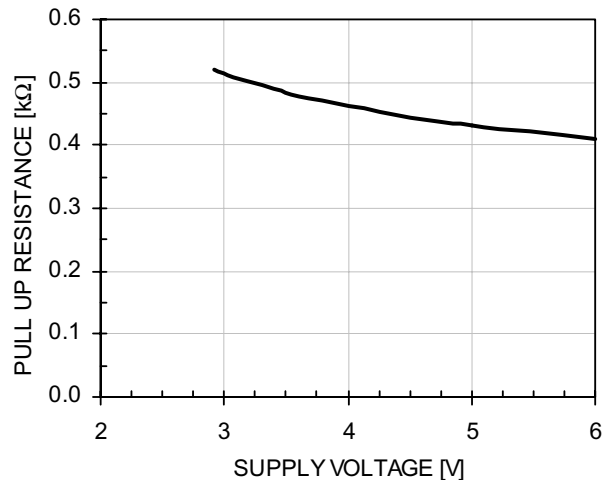



Performance Information (cont'd)

CM3404 Typical Thermal Characteristics (nominal conditions unless specified otherwise)

RESET Propagation Delay vs. Temperature

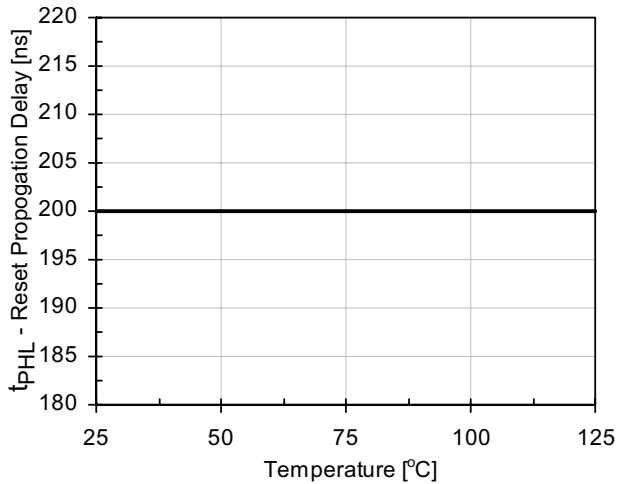

RESET Release Delay vs. Temperature

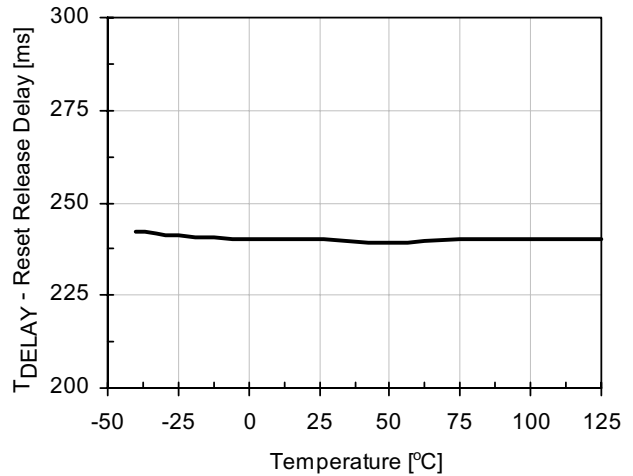

Ground Current vs. Temperature

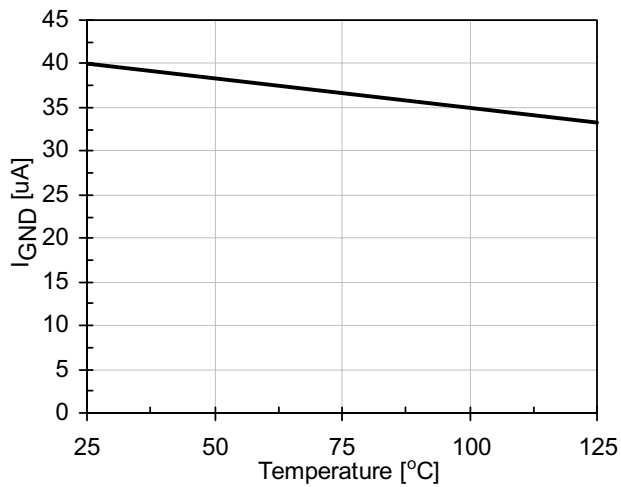

Threshold Voltage variation vs. Temperature

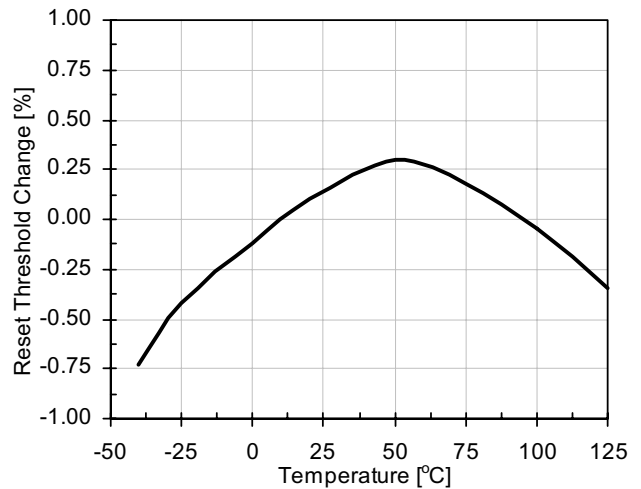



Mechanical Details

SOT23-3 Mechanical Specifications

Dimensions for CM3404 devices packaged in 3-pin SOT23 packages are presented below.

For complete information on the SOT23-3 package, see the California Micro Devices SOT23 Package Information document.

PACKAGE DIMENSIONS				
Package	SOT23-3 (JEDEC name is TO-236)			
Pins	3			
Dimensions	Millimeters		Inches	
	Min	Max	Min	Max
A	0.89	1.12	0.0350	0.0441
A1	0.01	0.10	0.0004	0.0039
b	0.30	0.50	0.0118	0.0197
c	0.08	0.20	0.0031	0.0079
D	2.80	3.04	0.1102	0.1197
E	2.10	2.64	0.0827	0.1039
E1	1.20	1.40	0.0472	0.0551
e	0.95 BSC		0.0374 BSC	
e1	1.90 BSC		0.0748 BSC	
L	0.40	0.60	0.0157	0.0236
L1	0.54 REF		0.0213 REF	
# per tape and reel	3000 pieces			
Controlling dimension: millimeters				

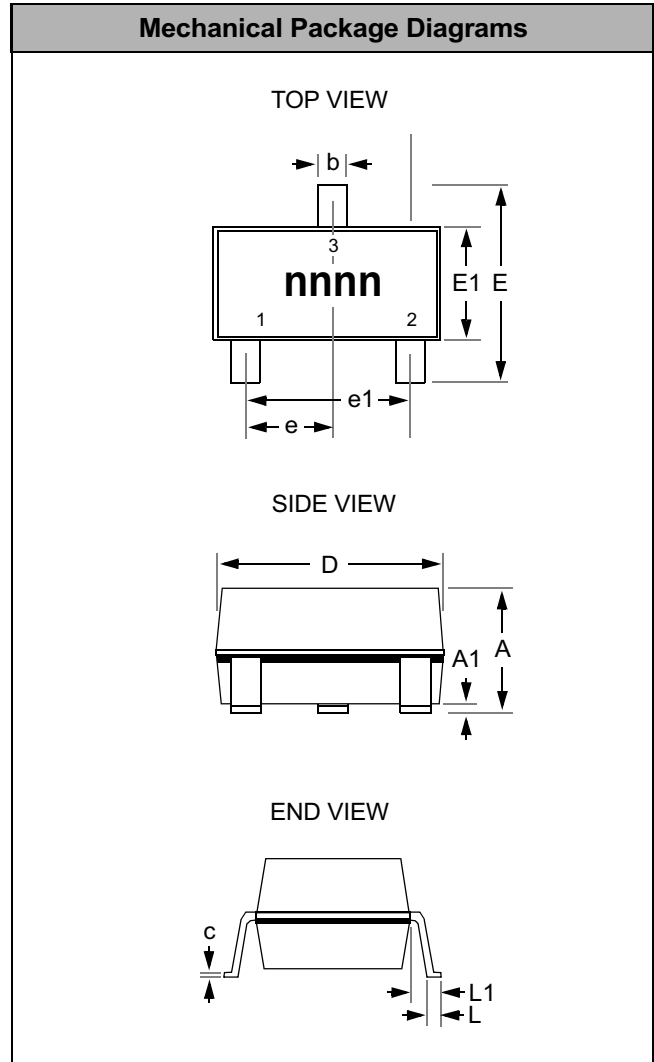

Package Dimensions for SOT23-3.