



AAT1151 850kHz 700mA Synchronous Buck DC/DC Converter

SwitchReg™

General Description

The AAT1151 SwitchReg™ is a member of AnalogicTech's Total Power Management IC™ (TPMIC™) product family. The step-down switching converter is ideal for applications where high efficiency is required over the full range of output load conditions. The 2.7V to 5.5V input voltage range makes the AAT1151 ideal for single-cell lithium-ion/polymer battery applications. Capable of more than 700mA with internal MOSFETs, the current-mode controlled IC provides high efficiency using synchronous rectification. Fully integrated compensation simplifies system design and lowers external parts count.

The device operates at a fixed 850kHz switching frequency and enters PFM mode for light load current to maintain high efficiency across all load conditions.

The AAT1151 is available in MSOP-8 and QFN33-16 packages and is rated over the -40°C to +85°C temperature range.

Features

- V_{IN} Range: 2.7V to 5.5V
- Up to 95% Efficiency
- High Initial Accuracy $\pm 1\%$
- $110m\Omega R_{DS(ON)}$ Internal Switches
- $<1\mu A$ Shutdown Current
- 850kHz Switching Frequency
- Fixed V_{OUT} or Adjustable $V_{OUT} \geq 1.0V$
- Integrated Power Switches
- Synchronous Rectification
- Current Mode Operation
- Internal Compensation
- Stable with Ceramic Capacitors
- PWM and PFM for Optimum Efficiency for All Load Conditions
- Internal Soft Start
- Over-Temperature Protection
- Current Limit Protection
- MSOP-8 and QFN33-16 Packages
- -40°C to +85°C Temperature Range

Applications

- Cellular Phones
- Digital Cameras
- MP3 Players
- Notebook Computers
- PDAs
- USB-Powered Equipment
- Wireless Notebook Adapters

Typical Application

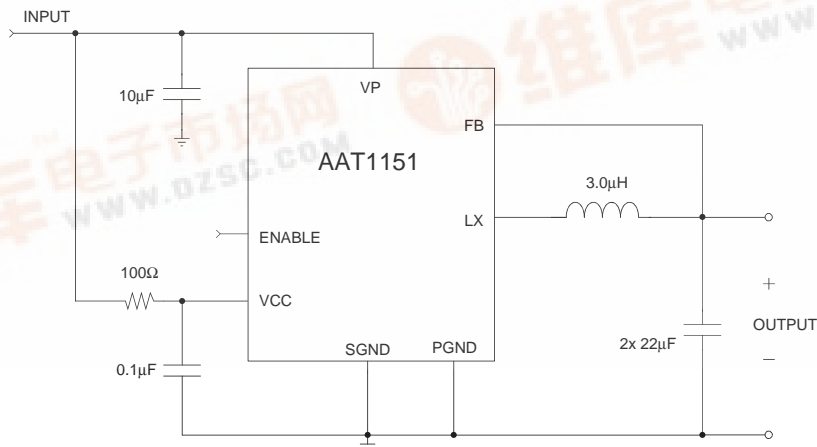

Pin Descriptions

Pin #		Symbol	Function
MSOP-8	QFN33-16		
1	4	FB	Feedback input pin. This pin is connected to the converter output. It is used to set the output of the converter to regulate to the desired value via an internal resistive divider. For an adjustable output, an external resistive divider is connected to this pin on the 1V model.
2	5, 6	SGND	Signal ground. Connect the return of all small signal components to this pin. (See board layout rules.)
3	7	EN	Enable input pin. A logic high enables the converter; a logic low forces the AAT1151 into shutdown mode reducing the supply current to less than 1µA. The pin should not be left floating.
4	9	VCC	Bias supply. Supplies power for the internal circuitry. Connect to input power via low pass filter with decoupling to SGND.
5	10, 11, 12	VP	Input supply voltage for the converter power stage. Must be closely decoupled to PGND.
6, 7	13, 14, 15	LX	Connect inductor to these pins. Switching node internally connected to the drain of both high- and low-side MOSFETs.
8	1, 2, 3	PGND	Main power ground return pin. Connect to the output and input capacitor return. (See board layout rules.)
	8, 16	NC	Not internally connected.
	EP		Exposed paddle (bottom); connect to PGND directly beneath package.

Pin Configuration

MSOP-8
(Top view)

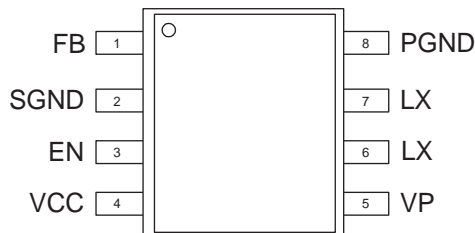

QFN33-16
(Top view)

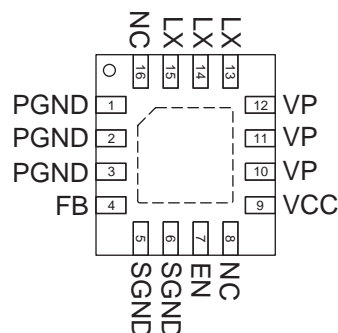

Absolute Maximum Ratings¹

Symbol	Description	Value	Units
V_{CC}, V_P	V_{CC}, V_P to GND	6	V
V_{LX}	LX to GND	-0.3 to $V_P+0.3$	V
V_{FB}	FB to GND	-0.3 to $V_{CC}+0.3$	V
V_{EN}	EN to GND	-0.3 to 6	V
T_J	Operating Junction Temperature Range	-40 to 150	°C
V_{ESD}	ESD Rating ² - HBM	3000	V

Thermal Characteristics³

Symbol	Description	Value	Units
θ_{JA}	Thermal Resistance (MSOP-8)	150	°C/W
P_D	Maximum Power Dissipation (MSOP-8) ($T_A = 25^\circ\text{C}$) ⁴	667	mW
θ_{JA}	Thermal Resistance (QFN33-16)	50	°C/W
P_D	Maximum Power Dissipation (QFN33-16) ($T_A = 25^\circ\text{C}$) ⁵	2.0	W

Recommended Operating Conditions

Symbol	Description	Value	Units
T	Ambient Temperature Range	-40 to 85	°C

1. Stresses above those listed in Absolute Maximum Ratings may cause permanent damage to the device. Functional operation at conditions other than the operating conditions specified is not implied. Only one Absolute Maximum Rating should be applied at any one time.
2. Human body model is a 100pF capacitor discharged through a 1.5kΩ resistor into each pin.
3. Mounted on a demo board.
4. Derate 6.7mW/°C above 25°C.
5. Derate 20mW/°C above 25°C.

Electrical Characteristics¹

$V_{IN} = V_{CC} = V_P = 5V$, $T_A = -40^{\circ}C$ to $85^{\circ}C$, unless otherwise noted. Typical values are at $T_A = 25^{\circ}C$.

Symbol	Description	Conditions	Min	Typ	Max	Units
V_{IN}	Input Voltage Range		2.7		5.5	V
V_{OUT}	Output Voltage Tolerance	$V_{IN} = V_{OUT} + 0.2$ to $5.5V$, $I_{OUT} = 0$ to $700mA$	-3.0		+3.0	%
V_{UVLO}	Under-Voltage Lockout	V_{IN} Rising			2.5	V
		V_{IN} Falling	1.2			
$V_{UVLO(HYS)}$	Under-Voltage Lockout Hysteresis			250		mV
I_{IL}	Input Low Current	$V_{IN} = V_{FB} = 5.5V$			1.0	μA
I_{IH}	Input High Current	$V_{IN} = V_{FB} = 0V$			1.0	μA
I_Q	Quiescent Supply Current	No Load, $V_{FB} = 0V$, $V_{IN} = 4.2V$ $T_A = 25^{\circ}C$		210	300	μA
I_{SHDN}	Shutdown Current	$V_{EN} = 0V$, $V_{IN} = 5.5V$			1.0	μA
I_{LIM}	Current Limit	$T_A = 25^{\circ}C$	1.2			A
$R_{DS(ON)H}$	High Side Switch On Resistance	$T_A = 25^{\circ}C$		110	150	m Ω
$R_{DS(ON)L}$	Low Side Switch On Resistance	$T_A = 25^{\circ}C$		100	150	m Ω
η	Efficiency	$I_{OUT} = 300mA$, $V_{IN} = 3.5V$		92		%
$\Delta V_{OUT} (V_{OUT} * \Delta V_{IN})$	Load Regulation	$V_{IN} = 4.2V$, $I_{LOAD} = 0$ to $700mA$		± 0.9		%
$\Delta V_{OUT}/V_{OUT}$	Line Regulation	$V_{IN} = 2.7V$ to $5.5V$		± 0.1		%/V
F_{OSC}	Oscillator Frequency	$T_A = 25^{\circ}C$	600	850	1200	KHz
$V_{EN(L)}$	Enable Threshold Low				0.6	V
$V_{EN(H)}$	Enable Threshold High		1.4			V
T_{SD}	Over-Temperature Shutdown Threshold			140		$^{\circ}C$
T_{HYS}	Over-Temperature Shutdown Hysteresis			15		$^{\circ}C$

1. The AAT1151 is guaranteed to meet performance specifications over the $-40^{\circ}C$ to $+85^{\circ}C$ operating range and is assured by design, characterization, and correlation with statistical process controls.



Typical Characteristics

No Load Supply Current vs. Input Voltage

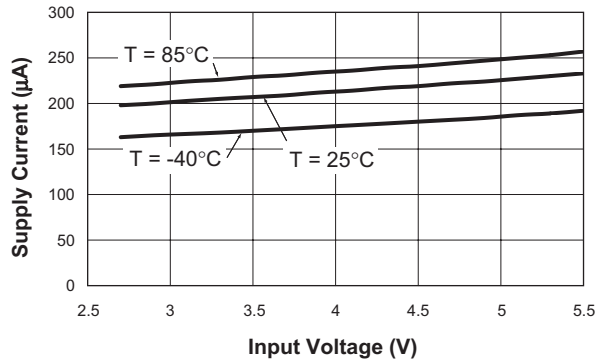

Frequency vs. Input Voltage

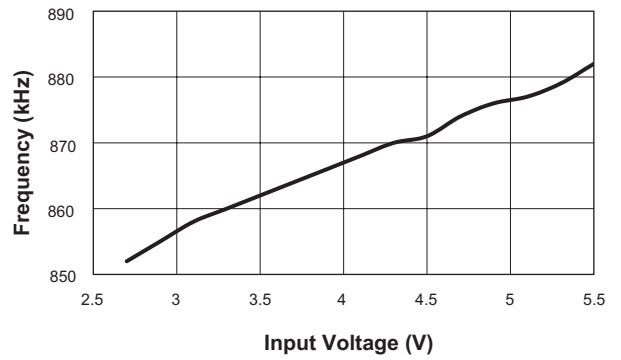

Output Voltage vs. Temperature

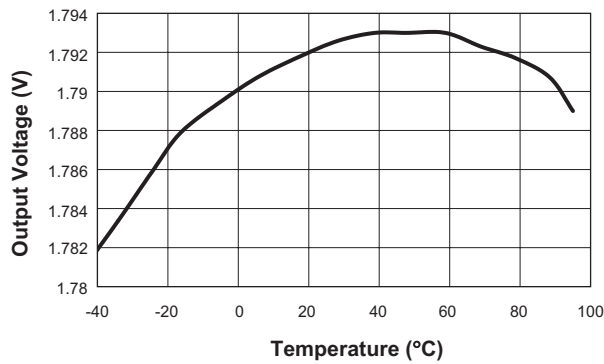

Load and Line Regulation

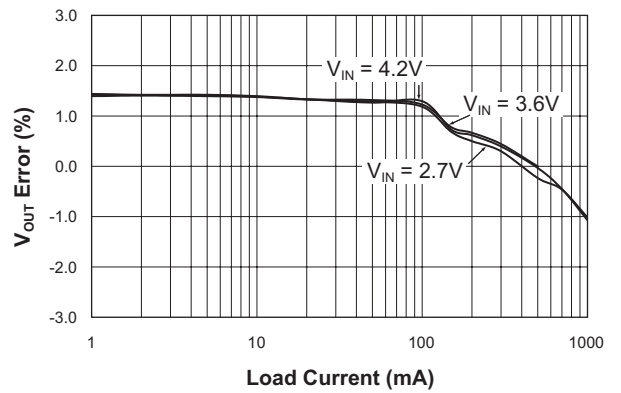

Switching Frequency vs. Temperature

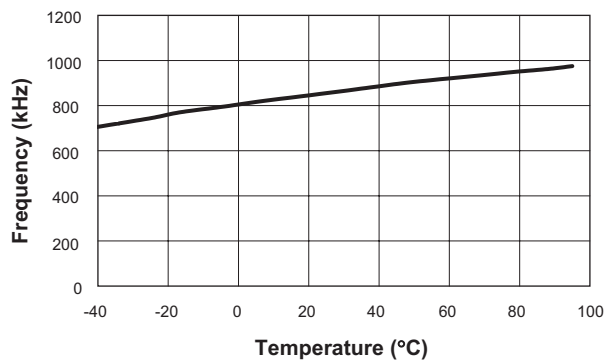

AAT1151 Efficiency
(V_{OUT} = 2.5V; L = 4.2µH)

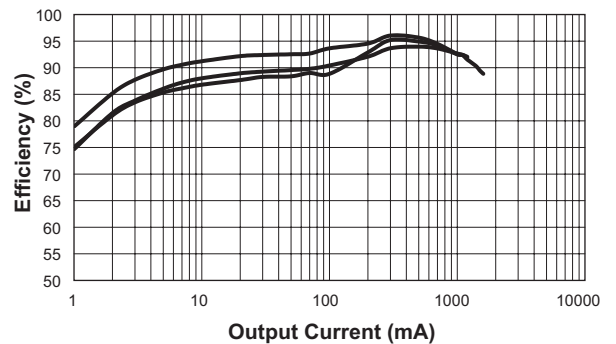

Typical Characteristics

Output Ripple 1.8V, 50mA, $V_{IN} = 3.6V$
Circuit of Figure 1

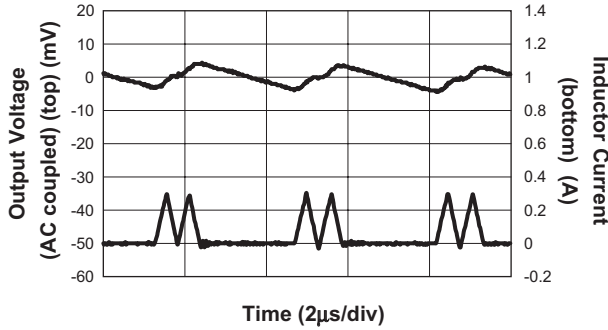

Line Transient Response 1.8V, 50mA
Circuit of Figure 1

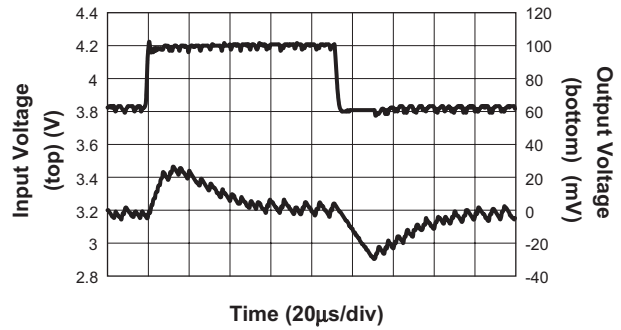

Output Ripple 1.8V, 0.7A, $V_{IN} = 3.6V$
Circuit of Figure 1

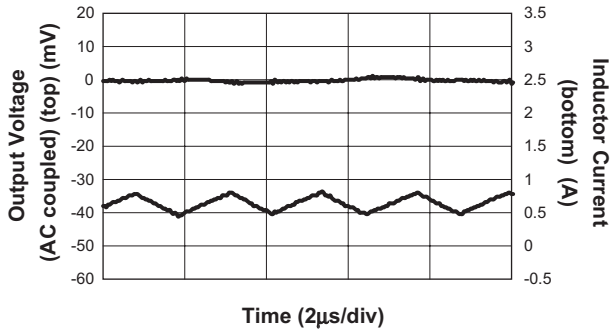

Line Transient Response 1.8V, 0.7A
Circuit of Figure 1

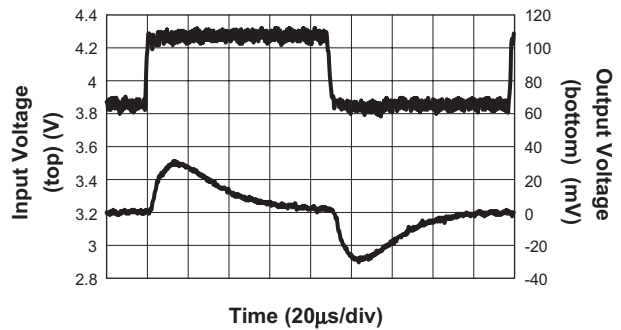

Load Transient Response 50mA to 0.7A
 $V_{IN} = 3.6V$ – Circuit of Figure 1

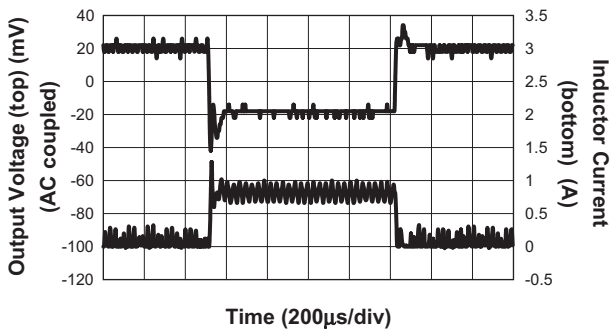

Soft Start 1.8V, 0.7A, $V_{IN} = 3.6V$
Circuit of Figure 1

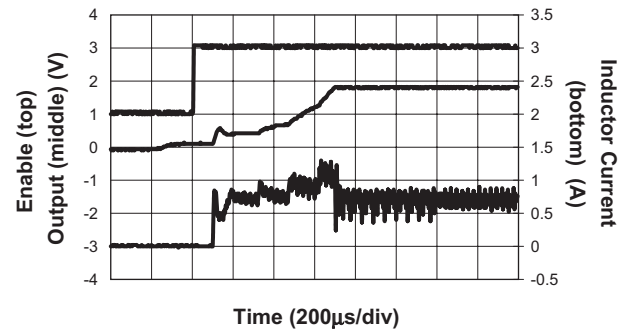

Typical Characteristics

Output Ripple
Circuit of Figure 1

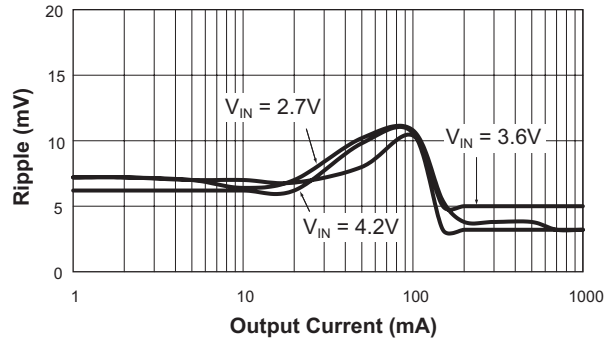

Functional Block Diagram

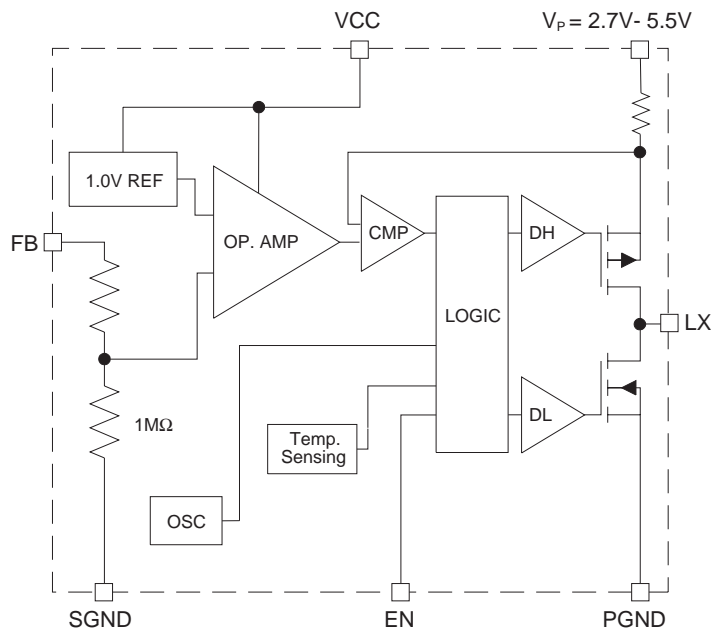

Operation

Control Loop

The AAT1151 is a peak current mode buck converter. The inner, wide bandwidth loop controls the peak current of the output inductor. The output inductor current is sensed through the P-channel MOSFET (high side) and is also used for short-circuit and overload protection. A fixed slope compensation signal is added to the sensed current to maintain stability. The loop appears as a voltage programmed current source in parallel with the output capacitor.

The voltage error amplifier output programs the current loop for the necessary inductor current to force a constant output voltage for all load and line conditions. The voltage feedback resistive divider is internal, dividing the output voltage to the error amplifier reference voltage of 1.0V. The voltage error amplifier does not have the large DC gain typical of most error amplifiers. This eliminates the need for external compensation components, while still providing sufficient DC loop gain for load regulation. The voltage loop crossover frequency and phase margin are set by the output capacitor value only.

PFM/PWM Operation

Light load efficiency is maintained by way of Pulse Frequency Modulation (PFM) control. The AAT1151 PFM control forces the peak inductor current to a minimum level regardless of load demand. At medium to high load demand, this has no effect on circuit operation and normal PWM controls take over. PFM reduces the switching frequency at light loads, thus reducing the associated switching losses.

Soft Start/Enable

Soft start increases the inductor current limit point in discrete steps when the input voltage or enable input is applied. It limits the current surge seen at the input and eliminates output voltage overshoot. When pulled low, the enable input forces the AAT1151 into a low-power, non-switching state. The total input current during shutdown is less than 1µA.

Power and Signal Source

Separate small signal ground and power supply pins isolate the internal control circuitry from the noise associated with the output MOSFET switching. The low pass filter R1 and C2 in schematic Figure 1 filters the noise associated with the power switching.

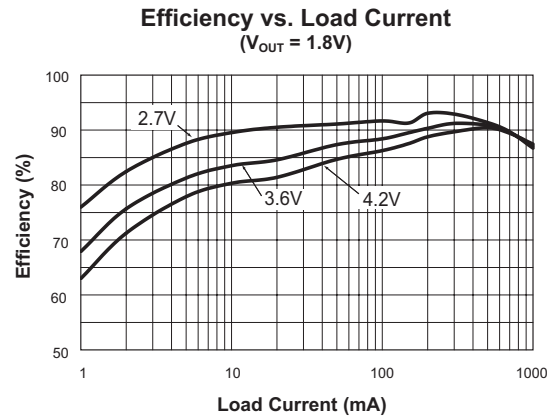
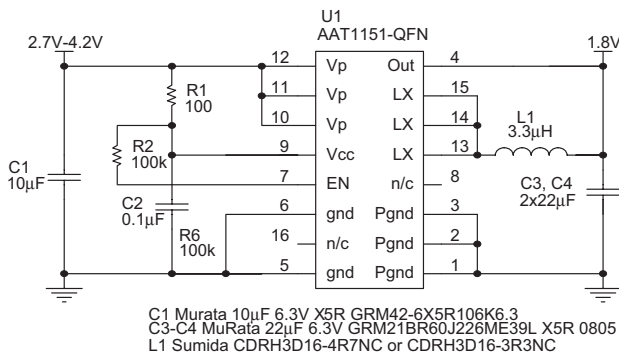

Figure 1: AAT1151 Evaluation Board.

Current Limit and Over-Temperature Protection

For overload conditions, the peak input current is limited. As load impedance decreases and the output voltage falls closer to zero, more power is dissipated internally, raising the device temperature. Thermal protection completely disables switching when internal dissipation becomes excessive, protecting the device from damage. The junction over-temperature threshold is 140°C with 10°C of hysteresis.

Inductor

The output inductor is selected to limit the ripple current to some predetermined value, typically 20% to 40% of the full load current at the maximum input voltage. Manufacturer's specifications list both the inductor DC current rating, which is a thermal limitation, and the peak current rating, which is determined by the saturation characteristics. The inductor should not show any appreciable saturation under normal load conditions. During overload and transient conditions, the average current in the inductor can meet or exceed the current limit point of the AAT1151. These conditions can tolerate greater saturation in the inductor without degradation in converter performance. Some inductors may meet the

peak and average current ratings yet result in excessive losses due to a high DCR. Always consider the losses associated with the DCR and its effect on the total converter efficiency when selecting an inductor.

For a 1.0 Amp load and the ripple set to 40% at the maximum input voltage, the maximum peak-to-peak ripple current is 280mA. The inductance value required is 2.84µH.

$$\begin{aligned}
 L &= \frac{V_{OUT}}{I_O \cdot k \cdot F} \cdot \left(1 - \frac{V_{OUT}}{V_{IN}}\right) \\
 &= \left(\frac{1.5V}{1A \cdot 0.4 \cdot 850kHz}\right) \cdot \left(1 - \frac{1.5V}{4.2V}\right) \\
 &= 2.84\mu H
 \end{aligned}$$

The factor "k" is the fraction of full load selected for the ripple current at the maximum input voltage. For ripple current at 40% of the full load current, the peak current will be 120% of full load. Selecting a standard value of 3.0µH gives 38% ripple current. A 3.0µH inductor selected from the Sumida CDRH5D28 series has a 24mΩ DCR and a 2.4A DC current rating. At full load, the inductor DC loss is 24mW, which amounts to a 1.6% loss in efficiency.

Input Capacitor

The primary function of the input capacitor is to provide a low impedance loop for the edges of pulsed current drawn by the AAT1151. A low ESR/ESL ceramic capacitor is ideal for this function. To minimize stray inductance, the capacitor should be placed as close as possible to the IC. This keeps the high frequency content of the input current localized, minimizing radiated and conducted EMI while facilitating optimum performance of the AAT1151. Ceramic X5R or X7R capacitors are ideal for this function. The size required will vary depending on the load, output voltage, and input voltage source impedance characteristics. A typical value is around 10 μ F. The input capacitor RMS current varies with the input voltage and the output voltage. The equation for the RMS current in the input capacitor is:

$$I_{RMS} = I_O \cdot \sqrt{\frac{V_O}{V_{IN}} \cdot \left(1 - \frac{V_O}{V_{IN}}\right)}$$

The input capacitor RMS ripple current reaches a maximum when V_{IN} is two times the output voltage where it is approximately one half of the load current. Losses associated with the input ceramic capacitor are typically minimal and are not an issue. Proper placement of the input capacitor can be seen in the reference design layout in Figures 2 and 4.

Output Capacitor

Since there are no external compensation components, the output capacitor has a strong effect on loop stability. Larger output capacitance will reduce the crossover frequency with greater phase margin. For the 1.5V 1A design using the 4.1 μ H inductor, two 22 μ F capacitors provide a stable output. In addition to assisting stability, the output capacitor limits the output ripple and provides holdup during large load transitions. The output capacitor RMS ripple current is given by:

$$I_{RMS} = \frac{1}{2 \cdot \sqrt{3}} \cdot \frac{V_{OUT} \cdot (V_{IN} - V_{OUT})}{L \cdot F \cdot V_{IN}}$$

For a ceramic capacitor, the ESR is so low that dissipation due to the RMS current of the capacitor is not a concern. Tantalum capacitors with sufficiently low ESR to meet output voltage ripple requirements also have an RMS current rating well beyond that actually seen in this application.

Layout

Figures 2 through 5 display the suggested PCB layout for the AAT1151. The following guidelines should be used to help ensure a proper layout.

- The input capacitor (C1) should connect as closely as possible to V_{POWER} (Pin 5) and P_{GND} (Pin 8).
- C2 and L1 should be connected as closely as possible. The connection L1 to the LX node should be as short as possible.
- The feedback trace (Pin 1) should be separate from any power trace and connect as closely as possible to the load point. Sensing along a high-current load trace will degrade DC load regulation.
- The resistance of the trace from the load return to the PGND (Pin 8) should be kept to a minimum. This will help to minimize any error in DC regulation due to differences in the potential of the internal signal ground and the power ground.
- Low pass filter R1 and C3 provide a cleaner bias source for the AAT1151 active circuitry. C3 should be placed as closely as possible to SGND (Pin 2) and V_{CC} (Pin 4). See Figures 2 and 7.

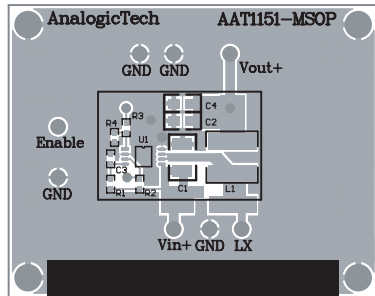

Figure 2: MSOP Evaluation Board Top Layer.

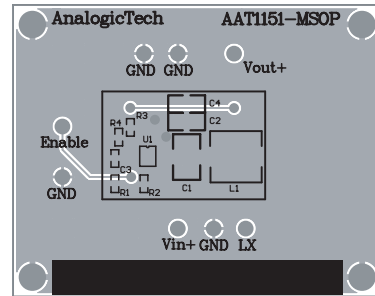

Figure 3: MSOP Evaluation Board Bottom Layer.

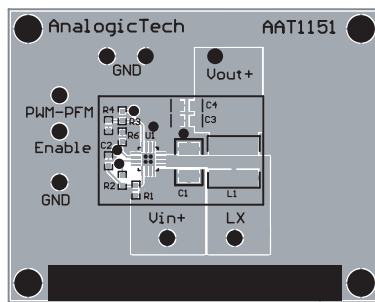

Figure 4: QFN Evaluation Board Top Side.

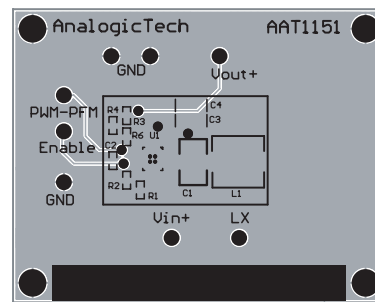

Figure 5: QFN Evaluation Board Bottom Side.

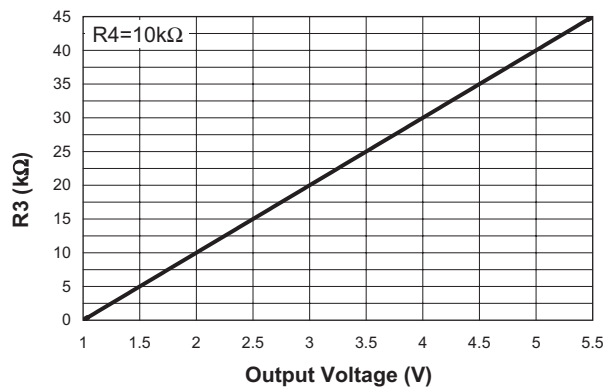
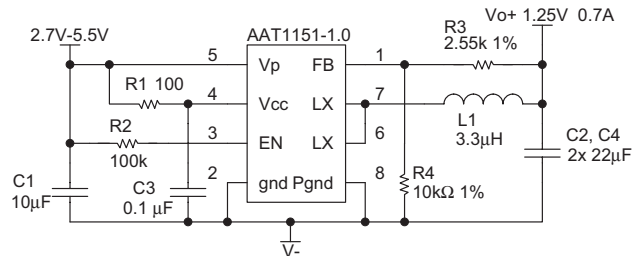

Figure 6: R3 vs. V_{OUT} for Adjustable Output Using the AAT1151-1.0V.



C1 Murata 10μF 6.3V X5R GRM42-6X5R106K6.3
C2, C4 MuRata 22μF 6.3V GRM21BR60J226ME39L X5R 0805
L1 Sumida CDRH3D16-3R3 NC

Figure 7: Adjustable Output Schematic.



Thermal Calculations

There are two types of losses associated with the AAT1151 output switching MOSFET: switching losses and conduction losses. Conduction losses are associated with the $R_{DS(ON)}$ characteristics of the output switching device. At the full load condition, assuming continuous conduction mode (CCM), a simplified form of the total losses is given by:

$$P = \frac{I_O^2 \cdot (R_{DS(ON)(HS)} \cdot V_O + R_{DS(ON)(LS)} \cdot (V_{IN} \cdot V_O))}{V_{IN}} + (t_{SW} \cdot F \cdot I_O \cdot V_{IN} + I_Q) \cdot V_{IN}$$

where I_Q is the AAT1151 quiescent current.

Once the total losses have been determined, the junction temperature can be derived from the θ_{JA} for the MSOP-8 package.

$$T_J = P \cdot \theta_{JA} + T_{AMB}$$

Adjustable Output

For applications requiring an output other than the fixed available, the 1V version can be programmed externally. Resistors R3 and R4 of Figure 7 force the output to regulate higher than 1 volt. R4 should be 100 times less than the 1M Ω internal resistance of the FB pin (recommended 10k Ω). Once R4 is selected, R3 can be calculated. For a 1.25 volt output with R4 set to 10.0k Ω , R3 is 2.55k Ω .

$$R3 = (V_O - 1) \cdot R4 = 0.25 \cdot 10k\Omega = 2.55k\Omega$$

Design Example

Specifications

I_{OUT}	0.7A
I_{RIPPLE}	40% of Full Load at Max V_{IN}
V_{OUT}	1.5V
V_{IN}	2.7V to 4.2V (3.6V nominal)
F_S	850kHz
T_{AMB}	85°C

Maximum Input Capacitor Ripple:

$$I_{RMS} = I_O \cdot \sqrt{\frac{V_O}{V_{IN}} \cdot \left(1 - \frac{V_O}{V_{IN}}\right)} = 0.35 \text{ Arms}, V_{IN} = 2 \times V_O$$

$$P = esr \cdot I_{RMS}^2 = 5 \text{ m}\Omega \cdot 0.35^2 \text{ A} = 0.6 \text{ mW}$$

Inductor Selection:

$$L = \frac{V_{OUT}}{I_O \cdot k \cdot F} \cdot \left(1 - \frac{V_{OUT}}{V_{IN}}\right) = \frac{1.5 \text{ V}}{0.7 \text{ A} \cdot 0.4 \cdot 850 \text{ kHz}} \cdot \left(1 - \frac{1.5 \text{ V}}{4.2 \text{ V}}\right) = 4.05 \mu\text{H}$$

Select Sumida inductor CDRH3D16 3.3 μ H 63m Ω 1.8mm height.

$$\Delta I = \frac{V_O}{L \cdot F} \cdot \left(1 - \frac{V_O}{V_{IN}}\right) = \frac{1.5 \text{ V}}{3.3 \mu\text{H} \cdot 850 \text{ kHz}} \cdot \left(1 - \frac{1.5 \text{ V}}{4.2 \text{ V}}\right) = 340 \text{ mA}$$

$$I_{PK} = I_{OUT} + \frac{\Delta I}{2} = 0.7 \text{ A} + 0.17 \text{ A} = 0.87 \text{ A}$$

$$P = I_O^2 \cdot DCR = (0.7)^2 \cdot 63 \text{ m}\Omega = 31 \text{ mW}$$

Output Capacitor Ripple Current:

$$I_{RMS} = \frac{1}{2 \cdot \sqrt{3}} \cdot \frac{V_{OUT} \cdot (V_{IN} - V_{OUT})}{L \cdot F \cdot V_{IN}} = \frac{1}{2 \cdot \sqrt{3}} \cdot \frac{1.5 \text{ V} \cdot (4.2 \text{ V} - 1.5 \text{ V})}{3.3 \mu\text{H} \cdot 850 \text{ kHz} \cdot 4.2 \text{ V}} = 99 \text{ mArms}$$

$$P_{esr} = esr \cdot I_{RMS}^2 = 5 \text{ m}\Omega \cdot 99^2 \text{ mA} = 50 \mu\text{W}$$

AAT1151 Dissipation:

$$P_{TOTAL} = \frac{I_O^2 \cdot (R_{DSON(H)} \cdot V_O + R_{DSON(L)} \cdot (V_{IN} - V_O))}{V_{IN}} + (t_{sw} \cdot F \cdot I_O + I_Q) \cdot V_{IN}$$

$$= \frac{(0.7A)^2 \cdot (0.2\Omega \cdot 1.5V + 0.187\Omega \cdot (4.2V - 1.5V))}{4.2V} + (20nsec \cdot 850kHz \cdot 0.7A + 0.3mA) \cdot 4.2V = 0.145W$$

$$T_{J(MAX)} = T_{AMB} + \Theta_{JA} \cdot P_{LOSS} = 85^\circ C + 150^\circ C/W \cdot 0.145W = 107^\circ C \quad (\text{MSOP-8})$$

$$= 85^\circ C + 50^\circ C/W \cdot 0.145W = 92^\circ C \quad (\text{QFN33-16})$$

Surface Mount Inductors

Manufacturer	Part Number	Value	Max DC Current	DCR (Ω)	Size (mm) L x W x H	Type
TaiyoYuden	NPO5DB4R7M	4.7 μ H	1.4A	0.038	5.9 x 6.1 x 2.8	Shielded
Toko	A914BYW-3R5M-D52LC	3.5 μ H	1.34A	0.073	5.0 x 5.0 x 2.0	Shielded
Sumida	CDRH5D28-3R0	3.0 μ H	2.4A	0.024	5.7 x 5.7 x 3.0	Shielded
Sumida	CDRH5D28-4R2	4.2 μ H	2.2A	0.031	5.7 x 5.7 x 3.0	Shielded
Sumida	CDRH5D18-4R1	4.1 μ H	1.95A	0.057	5.7 x 5.7 x 2.0	Shielded
MuRata	LQH55DN4R7M03	4.7 μ H	2.7A	0.041	5.0 x 5.0 x 4.7	Non-Shielded
MuRata	LQH66SN4R7M03	4.7 μ H	2.2A	0.025	6.3 x 6.3 x 4.7	Shielded
MuRata	CDRH3D16-3R3	3.3 μ H	1.1A	0.063	3.8 x 3.8 x 1.8	Shielded

Surface Mount Capacitors

Manufacturer	Part Number	Value	Voltage	Temp. Co.	Case
MuRata	GRM40 X5R 106K 6.3	10 μ F	6.3V	X5R	0805
MuRata	GRM42-6 X5R 106K 6.3	10 μ F	6.3V	X5R	1206
MuRata	GRM21BR60J226ME39L	22 μ F	6.3V	X5R	0805
MuRata	GRM21BR60J106ME39L	10 μ F	6.3V	X5R	0805

Ordering Information

Output Voltage ¹	Package	Marking ²	Part Number (Tape and Reel) ³
1.0V (Adj $V_{OUT} \geq 1.0V$)	MSOP-8	JHXYY	AAT1151IKS-1.0-T1
1.0V (Adj $V_{OUT} \geq 1.0V$)	QFN33-16	JHXYY	AAT1151IVN-1.0-T1
1.8V	MSOP-8	JIXYY	AAT1151IKS-1.8-T1
1.8V	QFN33-16	JIXYY	AAT1151IVN-1.8-T1
2.5V	MSOP-8	JJXYY	AAT1151IKS-2.5-T1
2.5V	QFN33-16	JJXYY	AAT1151IVN-2.5-T1
3.3V	MSOP-8	NKXYY	AAT1151IKS-3.3-T1

Package Information

MSOP-8

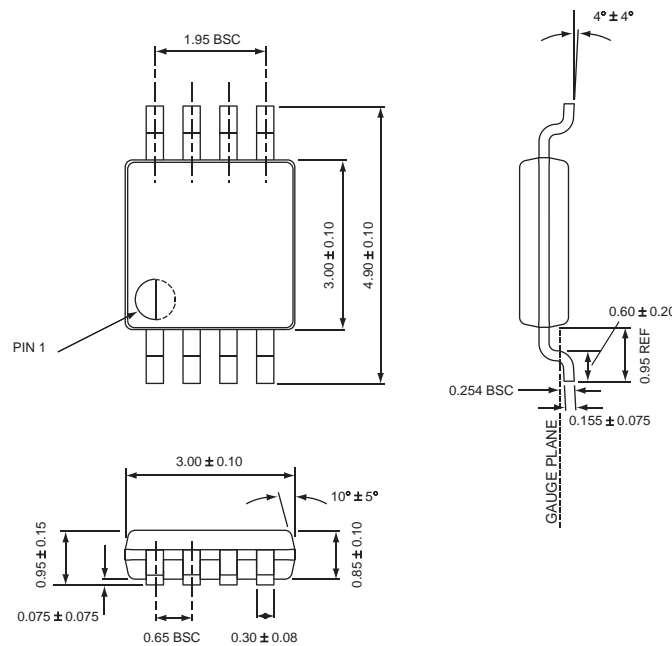

All dimensions in millimeters.

- Contact local sales office for custom options.
- XYX = assembly and date code.
- Sample stock is generally held on part numbers listed in **BOLD**.

QFN33-16

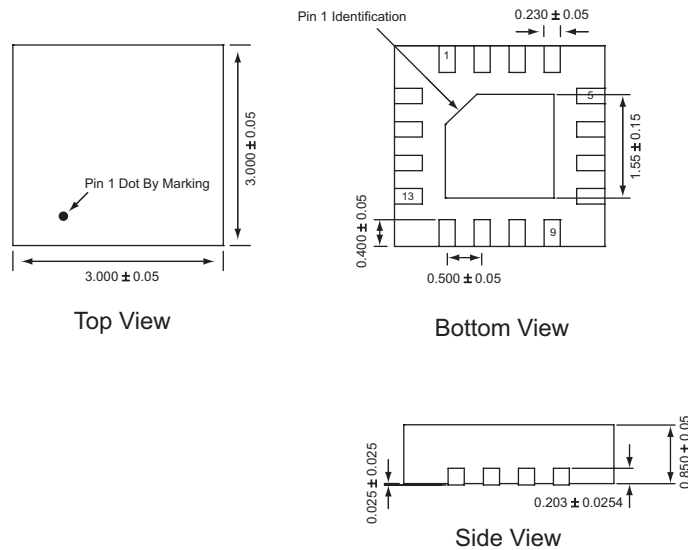

All dimensions in millimeters.

© Advanced Analogic Technologies, Inc.

AnalogicTech cannot assume responsibility for use of any circuitry other than circuitry entirely embodied in an AnalogicTech product. No circuit patent licenses, copyrights, mask work rights, or other intellectual property rights are implied. AnalogicTech reserves the right to make changes to their products or specifications or to discontinue any product or service without notice. Customers are advised to obtain the latest version of relevant information to verify, before placing orders, that information being relied on is current and complete. All products are sold subject to the terms and conditions of sale supplied at the time of order acknowledgement, including those pertaining to warranty, patent infringement, and limitation of liability. AnalogicTech warrants performance of its semiconductor products to the specifications applicable at the time of sale in accordance with AnalogicTech's standard warranty. Testing and other quality control techniques are utilized to the extent AnalogicTech deems necessary to support this warranty. Specific testing of all parameters of each device is not necessarily performed.

Advanced Analogic Technologies, Inc.
 830 E. Arques Avenue, Sunnyvale, CA 94085
 Phone (408) 737-4600
 Fax (408) 737-4611