



# AAT4280A

## Slew Rate Controlled Load Switch

SmartSwitch™

### General Description

The AAT4280A SmartSwitch is a member of AnalogicTech's Application Specific Power MOSFET™ (ASPM™) product family. The AAT4280A is a P-channel MOSFET power switch designed for high-side load switching applications. The device has a typical  $R_{DS(ON)}$  of 80mΩ, allowing increased load switch power handling capacity. The device is available in three different versions with flexible turn-on and turn-off characteristics — from very fast to slew rate limited. The standard AAT4280A (-1) version has a slew rate limited turn-on load switch and is functionally compatible with the AAT4250 device, while offering superior  $R_{DS(ON)}$  characteristics. The AAT4280A (-2) version features fast load switch turn-on capabilities, typically less than 500ns turn-on and 3μs turn-off times. The AAT4280A (-3) variation offers a shutdown load discharge circuit to rapidly turn off a load circuit when the switch is disabled. All AAT4280A load switch versions operate with an input voltage ranging from 1.5V to 5.5V, making them ideal for both 3V and 5V systems. Input logic levels are TTL and 2.5V to 5V CMOS compatible. The quiescent supply current is very low, typically 25nA.

The AAT4280A is available in a Pb-free, 8-pin SC70JW package and is specified over the -40°C to +85°C temperature range.

### Features

- 1.5V to 5.5V Input Voltage Range
- Very Low  $R_{DS(ON)}$ , Typically 80mΩ (5V)
- Slew Rate Limited Turn-On Time Options
  - 1ms
  - 0.5μs
  - 100μs
- Fast Shutdown Load Discharge Option
- Low Quiescent Current
  - 25nA (typ)
- TTL/CMOS Input Logic Level
- Temperature Range: -40°C to +85°C
- 4kV ESD Rating
- 8-Pin SC70JW Package

### Applications

- Cellular Telephones
- Digital Still Cameras
- Hot Swap Supplies
- Notebook Computers
- Personal Communication Devices
- Personal Digital Assistants (PDAs)

### Typical Application

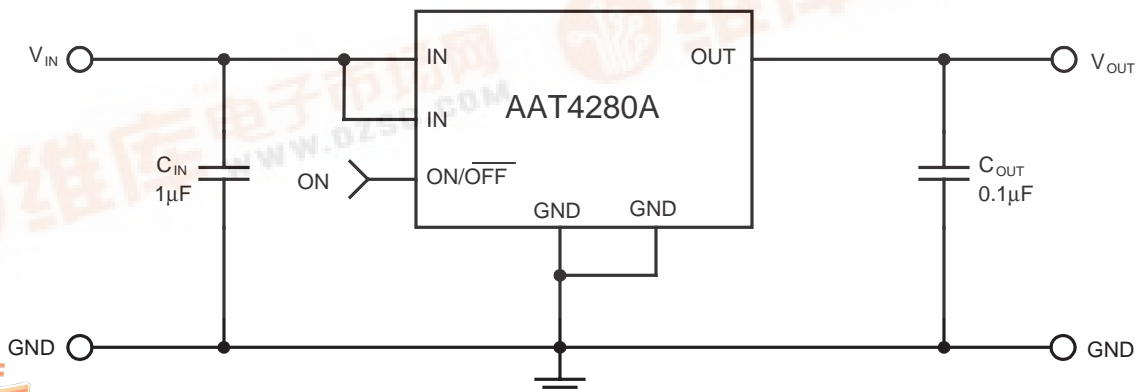

### Pin Descriptions

Pin #	Symbol	Function
1, 5, 6, 7, 8	IN	This pin is the input to the P-channel MOSFET source. Bypass to ground through a 1.0 $\mu$ F capacitor.
2	OUT	This pin is the P-channel MOSFET drain connection. Bypass to ground through a 0.1 $\mu$ F capacitor.
3	ON/OFF	Enable input.
4	GND	Ground connection.

### Pin Configuration

**SC70JW-8  
(Top View)**

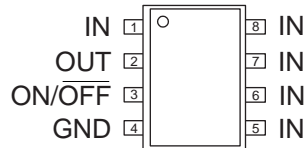

### Selector Guide

Part Number	Slew Rate (typ)	Active Pull Down	Enable
AAT4280A-1	1ms		Active High
AAT4280A-2	0.5 $\mu$ s		Active High
AAT4280A-3	100 $\mu$ s	√	Active High

### Absolute Maximum Ratings<sup>1</sup>

$T_A = 25^\circ\text{C}$ , unless otherwise noted.

Symbol	Description	Value	Units
$V_{IN}$	IN to GND	-0.3 to 6	V
$V_{ON}$	ON/OFF to GND	-0.3 to 6	V
$V_{OUT}$	OUT to GND	-0.3 to $V_{IN} + 0.3$	V
$I_{MAX}$	Maximum Continuous Switch Current	2.3	A
$I_{DM}$	Maximum Pulsed Current	$IN \geq 2.5V$	6
		$IN < 2.5V$	3
$T_J$	Operating Junction Temperature Range	-40 to 150	$^\circ\text{C}$
$T_S$	Storage Temperature Range	-65 to 150	$^\circ\text{C}$
$T_{LEAD}$	Maximum Soldering Temperature (at leads)	300	$^\circ\text{C}$
$V_{ESD}$	ESD Rating <sup>2</sup> - HBM	4000	V

### Thermal Characteristics<sup>3</sup>

Symbol	Description	Value	Units
$\Theta_{JA}$	Thermal Resistance	140	$^\circ\text{C}/\text{W}$
$P_D$	Power Dissipation	714	mW

1. Stresses above those listed in Absolute Maximum Ratings may cause permanent damage to the device. Functional operation at conditions other than the operating conditions specified is not implied. Only one Absolute Maximum Rating should be applied at any one time.  
 2. Human body model is a 100pF capacitor discharged through a 1.5k $\Omega$  resistor into each pin.  
 3. Mounted on an AAT4280A demo board in still 25 $^\circ\text{C}$  air.

### Electrical Characteristics

Unless otherwise noted,  $V_{IN} = 5V$ ,  $T_A = -40^\circ C$  to  $+85^\circ C$ ; typical values are  $T_A = 25^\circ C$ .

Symbol	Description	Conditions	Min	Typ	Max	Units
<b>AAT4280A All Versions</b>						
$V_{IN}$	Operation Voltage		1.5		5.5	V
$I_Q$	Quiescent Current	ON/ $\overline{OFF}$ = Active			1	$\mu A$
$I_{Q(off)}$	Off Supply Current	ON/ $\overline{OFF}$ = Inactive, OUT = Open			1	$\mu A$
$I_{SD(off)}$	Off Switch Current	ON/ $\overline{OFF}$ = Inactive, $V_{OUT} = 0$			1	$\mu A$
$R_{DS(on)}$	On Resistance	$V_{IN} = 5V, T_A = 25^\circ C$		80	120	m $\Omega$
		$V_{IN} = 4.2V, T_A = 25^\circ C$		85	130	
		$V_{IN} = 3V, T_A = 25^\circ C$		100	150	
		$V_{IN} = 1.8V, T_A = 25^\circ C$		160	250	
		$V_{IN} = 1.5V, T_A = 25^\circ C$		200	300	
$TC_{RDS}$	On Resistance Temperature Coefficient			2800		ppm/ $^\circ C$
$V_{IL}$	ON/ $\overline{OFF}$ Input Logic Low Voltage	$V_{IN} = 1.8V$ to $5.5V^1$			0.4	V
$V_{IH}$	ON/ $\overline{OFF}$ Input Logic High Voltage	$V_{IN} = 2.7V$ to $4.2V$	2			V
		$V_{IN} = 4.2V$ to $5.5V$	2.4			
		$V_{IN} = 1.5V$ to $2.7V$	1.4			
$I_{SINK}$	ON/ $\overline{OFF}$ Input Leakage	$V_{ON/\overline{OFF}} = 5.5V$			1	$\mu A$
<b>AAT4280A-1</b>						
$T_{D(ON)}$	Output Turn-On Delay	$V_{IN} = 5V, R_{LOAD} = 10\Omega, T_A = 25^\circ C$		20	40	$\mu s$
$T_{ON}$	Output Turn-On Rise Time	$V_{IN} = 5V, R_{LOAD} = 10\Omega, T_A = 25^\circ C$		1000	1500	$\mu s$
$T_{D(OFF)}$	Output Turn-Off Delay Time	$V_{IN} = 5V, R_{LOAD} = 10\Omega, T_A = 25^\circ C$		4	10	$\mu s$
<b>AAT4280A-2</b>						
$T_{D(ON)}$	Output Turn-On Delay	$V_{IN} = 5V, R_{LOAD} = 10\Omega, T_A = 25^\circ C$		0.5	2	$\mu s$
$T_{ON}$	Output Turn-On Rise Time	$V_{IN} = 5V, R_{LOAD} = 10\Omega, T_A = 25^\circ C$		0.5	1	$\mu s$
$T_{D(OFF)}$	Output Turn-Off Delay Time	$V_{IN} = 5V, R_{LOAD} = 10\Omega, T_A = 25^\circ C$		4	10	$\mu s$
<b>AAT4280A-3</b>						
$T_{D(ON)}$	Output Turn-On Delay	$V_{IN} = 5V, R_{LOAD} = 10\Omega, T_A = 25^\circ C$		20	40	$\mu s$
$T_{ON}$	Output Turn-On Rise Time	$V_{IN} = 5V, R_{LOAD} = 10\Omega, T_A = 25^\circ C$		100	150	$\mu s$
$T_{D(OFF)}$	Output Turn-Off Delay Time	$V_{IN} = 5V, R_{LOAD} = 10\Omega, T_A = 25^\circ C$		4	10	$\mu s$
$R_{PD}$	Output Pull-Down Resistance During OFF	ON/ $\overline{OFF}$ = Inactive, $T_A = 25^\circ C$		150	250	$\Omega$

1. For  $V_{IN}$  outside this range, consult typical ON/ $\overline{OFF}$  threshold curve.

### Typical Characteristics

Unless otherwise noted,  $V_{IN} = 5V$ ,  $T_A = 25^\circ C$ .

Quiescent Current vs. Temperature

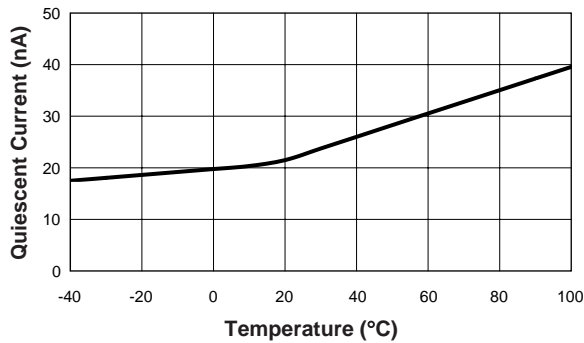

$R_{DS(ON)}$  vs. Input Voltage

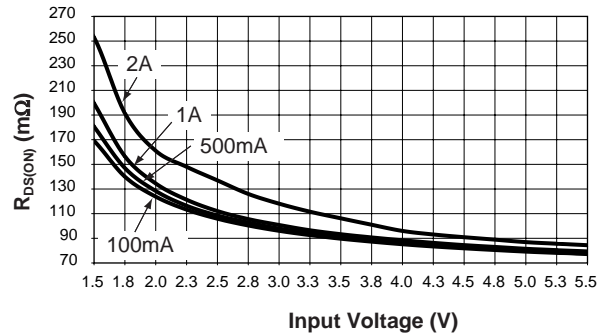

$R_{DS(ON)}$  vs. Temperature

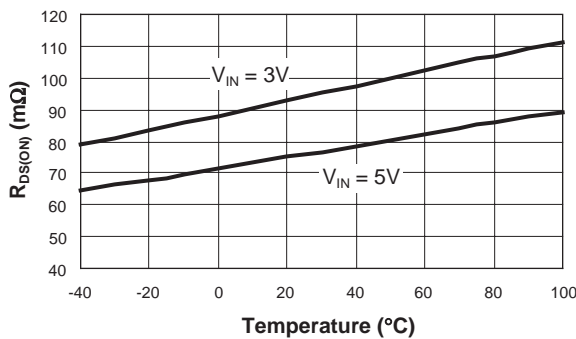

ON/OFF Threshold vs. Input Voltage

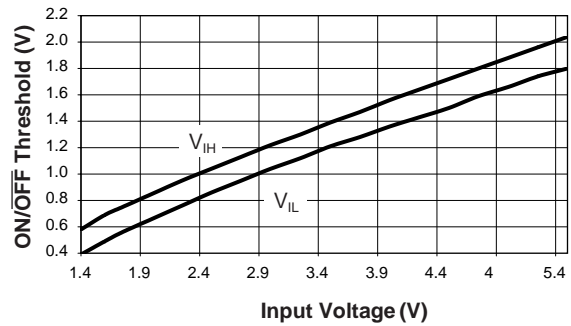

Off-Switch Current vs. Temperature

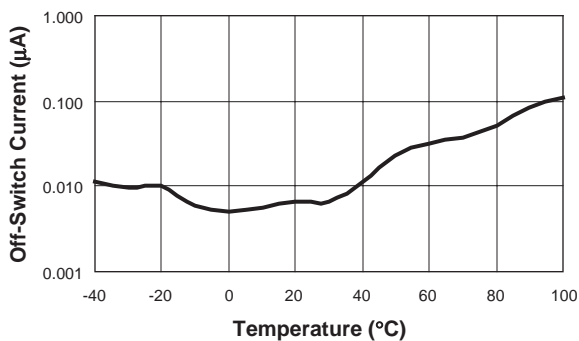

### Typical Characteristics—AAT4280A-1

Unless otherwise noted,  $V_{IN} = 5V$ ,  $T_A = 25^\circ C$ .

**AAT4280A-1 Turn-On**  
( $V_{IN} = 3V$ ;  $R_L = 6\Omega$ )

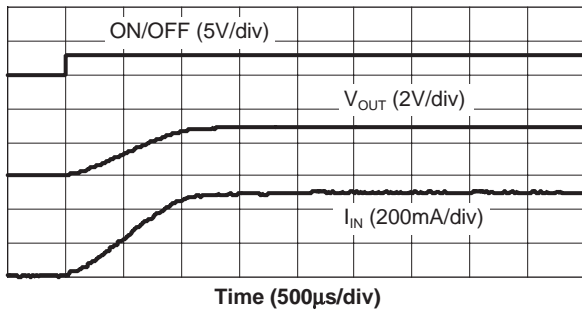

**AAT4280A-1 Turn-On**  
( $V_{IN} = 5V$ ;  $R_L = 10\Omega$ )

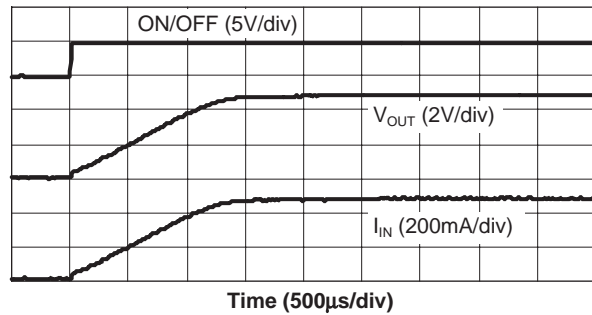

**AAT4280A-1 Turn-Off**  
( $V_{IN} = 3V$ ;  $R_L = 6\Omega$ )

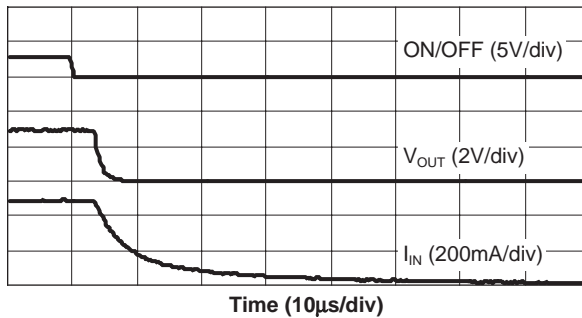

**AAT4280A-1 Turn-Off**  
( $V_{IN} = 5V$ ;  $R_L = 10\Omega$ )

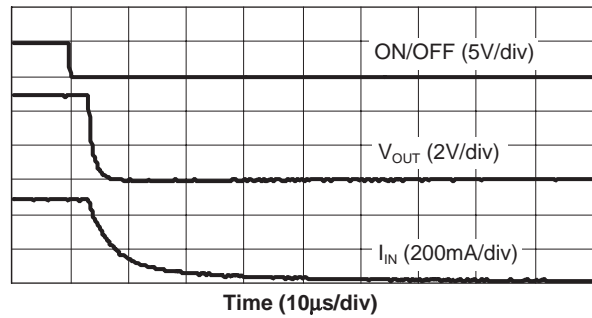

### Typical Characteristics—AAT4280A-2

Unless otherwise noted,  $V_{IN} = 5V$ ,  $T_A = 25^\circ C$ .

**AAT4280A-2 Turn-On**  
( $V_{IN} = 3V$ ;  $R_{IN} = 6\Omega$ )

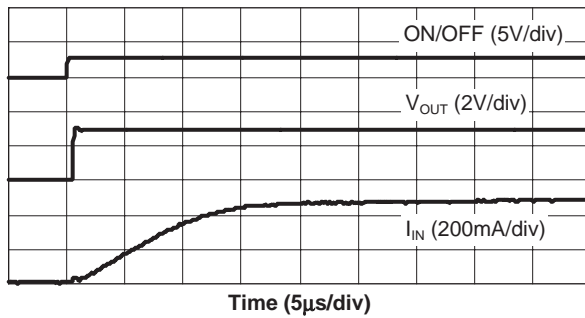

**AAT4280A-2 Turn-On**  
( $V_{IN} = 5V$ ;  $R_L = 10\Omega$ )

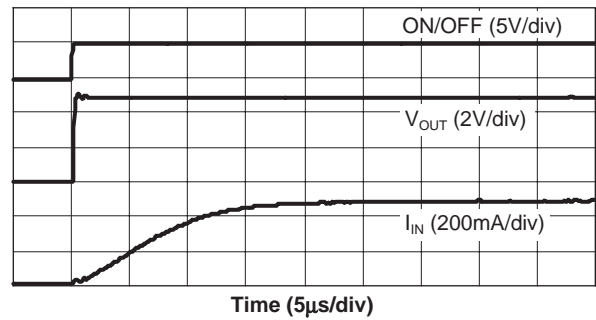

**AAT4280A-2 Turn-Off**  
( $V_{IN} = 3V$ ;  $R_L = 6\Omega$ )

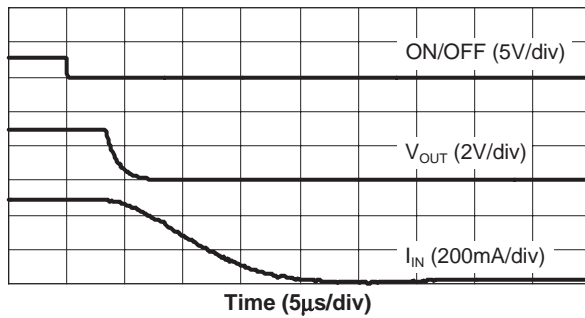

**AAT4280A-2 Turn-Off**  
( $V_{IN} = 5V$ ;  $R_L = 10\Omega$ )

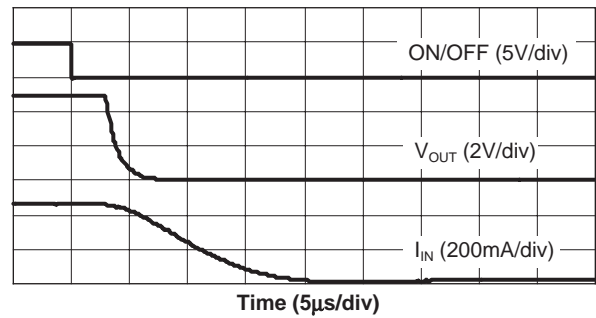

### Typical Characteristics—AAT4280A-3

Unless otherwise noted,  $V_{IN} = 5V$ ,  $T_A = 25^\circ C$ .

**AAT4280A-3 Turn-On**  
( $V_{IN} = 3V$ ;  $R_L = 6\Omega$ )

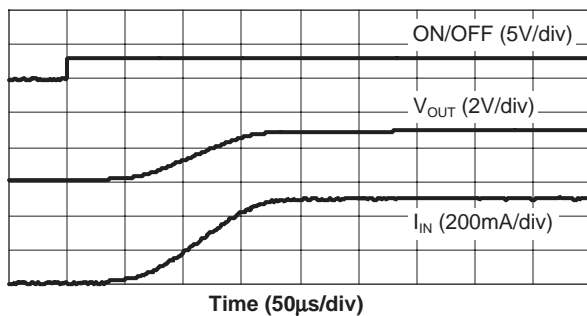

**AAT4280A-3 Turn-On**  
( $V_{IN} = 5V$ ;  $R_L = 10\Omega$ )

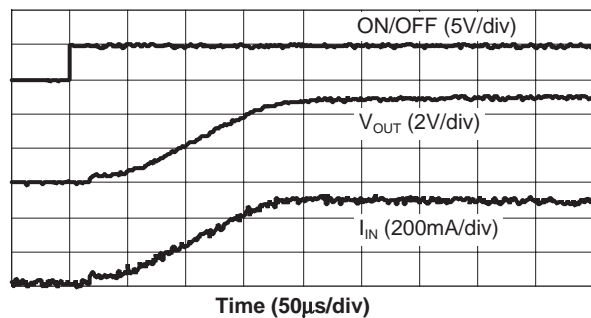

**AAT4280A-3 Turn-Off**  
( $V_{IN} = 3V$ ;  $R_L = 6\Omega$ )

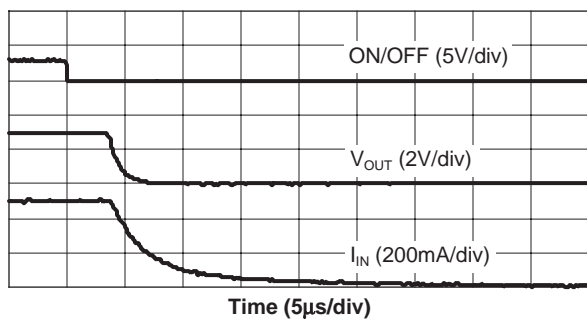

**AAT4280A-3 Turn-Off**  
( $V_{IN} = 5V$ ;  $R_L = 10\Omega$ )

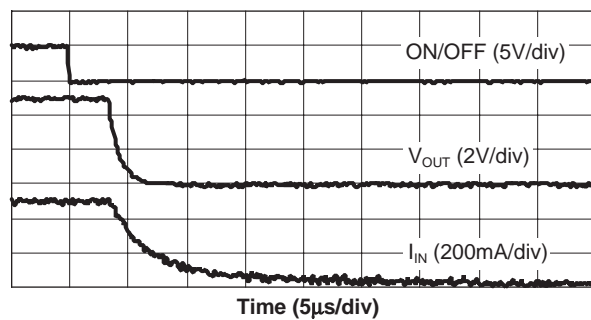



### Functional Block Diagram

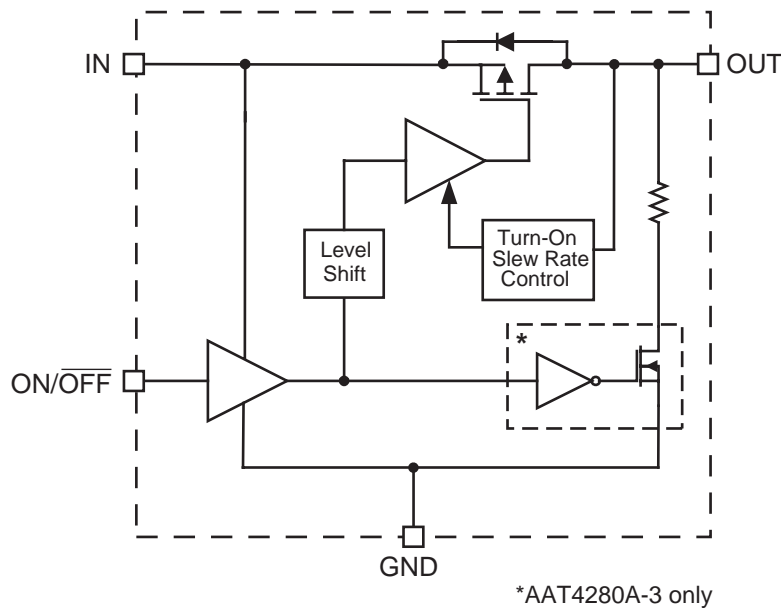

### Functional Description

The AAT4280A is a family of flexible P-channel MOSFET power switches designed for high-side load switching applications. There are three versions of the AAT4280A with different turn-on and turn-off characteristics to choose from, depending upon the specific requirements of an application. The first version, the AAT4280A-1, has a moderate turn-on slew rate feature, which reduces inrush current when the MOSFET is turned on. This function allows the load switch to be implemented with either a small input capacitor or no input capacitor at all. During turn-on slewing, the current ramps linearly until it reaches the level required for the output load condition. The proprietary turn-on current control method works by careful control and monitoring of the MOSFET gate voltage. When the device is switched ON, the gate voltage is quickly increased to the threshold level of the MOSFET. Once at this level, the current begins to slew as the gate voltage is slowly increased until the MOSFET

becomes fully enhanced. Once it has reached this point, the gate is quickly increased to the full input voltage and  $R_{DS(ON)}$  is minimized.

The second version, the AAT4280A-2, is a very fast switch intended for high-speed switching applications. This version has no turn-on slew rate control and no special output discharge features.

The final switch version, the AAT4280A-3, has the addition of a minimized slew rate limited turn-on function and a shutdown output discharge circuit to rapidly turn off a load when the load switch is disabled through the ON/OFF pin.

All versions of the AAT4280A operate with input voltages ranging from 1.5V to 5.5V. All versions of this device have extremely low operating current, making them ideal for battery-powered applications. The ON/OFF control pin is TTL compatible and will also function with 2.5V to 5V logic systems, making the AAT4280A an ideal level-shifting load switch.

### Applications Information

#### Input Capacitor

A 1µF or larger capacitor is typically recommended for C<sub>IN</sub> in most applications. A C<sub>IN</sub> capacitor is not required for basic operation; however, C<sub>IN</sub> is useful in preventing load transients from affecting upstream circuits. C<sub>IN</sub> should be located as close to the device V<sub>IN</sub> pin as practically possible. Ceramic, tantalum, or aluminum electrolytic capacitors may be selected for C<sub>IN</sub>. There is no specific capacitor ESR requirement for C<sub>IN</sub>; however, for higher current operation, ceramic capacitors are recommended for C<sub>IN</sub> due to their inherent capability over tantalum capacitors to withstand input current surges from low impedance sources, such as batteries in portable devices.

#### Output Capacitor

For proper slew operation, a 0.1µF capacitor or greater between V<sub>OUT</sub> and GND is recommended. The output capacitor has no specific capacitor type or ESR requirement. If desired, C<sub>OUT</sub> may be increased without limit to accommodate any load transient condition without adversely affecting the device turn-on slew rate time.

#### Enable Function

The AAT4280A features an enable / disable function. This pin (ON/ $\overline{\text{OFF}}$ ) is compatible with both TTL or CMOS logic.

#### Reverse Output-to-Input Voltage Conditions and Protection

Under normal operating conditions, a parasitic diode exists between the output and input of the load switch. The input voltage should always remain greater than the output load voltage, maintaining a reverse bias on the internal parasitic diode. Conditions where V<sub>OUT</sub> might exceed V<sub>IN</sub> should be avoided since this would forward bias the internal parasitic diode and allow excessive current flow into the V<sub>OUT</sub> pin and possibly damage the load switch.

In applications where there is a possibility of V<sub>OUT</sub> exceeding V<sub>IN</sub> for brief periods of time during normal operation, the use of a larger value C<sub>IN</sub> capacitor is highly recommended. A larger value of C<sub>IN</sub> with respect to C<sub>OUT</sub> will effect a slower C<sub>IN</sub> decay rate during shutdown, thus preventing V<sub>OUT</sub> from exceeding V<sub>IN</sub>. In applications where there is a greater danger of V<sub>OUT</sub> exceeding V<sub>IN</sub> for extended periods of time, it is recommended to place a Schottky diode from V<sub>IN</sub> to V<sub>OUT</sub> (connecting the cathode to V<sub>IN</sub> and anode to V<sub>OUT</sub>). The Schottky diode forward voltage should be less than 0.45V.

#### Thermal Considerations and High Output Current Applications

The AAT4280A is designed to deliver a continuous output load current. The limiting characteristic for maximum safe operating output load current is package power dissipation. In order to obtain high operating currents, careful device layout and circuit operating conditions need to be taken into account.

The following discussions will assume the load switch is mounted on a printed circuit board utilizing the minimum recommended footprint, as stated in the Layout Considerations section of this datasheet.

At any given ambient temperature (T<sub>A</sub>), the maximum package power dissipation can be determined by the following equation:

$$P_{D(\text{MAX})} = \frac{[T_{J(\text{MAX})} - T_A]}{\theta_{JA}}$$

Constants for the AAT4280A are maximum junction temperature, T<sub>J(MAX)</sub> = 125°C, and package thermal resistance,  $\theta_{JA}$  = 120°C/W. Worst case conditions are calculated at the maximum operating temperature where T<sub>A</sub> = 85°C. Typical conditions are calculated under normal ambient conditions where T<sub>A</sub> = 25°C. At T<sub>A</sub> = 85°C, P<sub>D(MAX)</sub> = 333mW. At T<sub>A</sub> = 25°C, P<sub>D(MAX)</sub> = 833mW.

The maximum continuous output current for the AAT4280A is a function of the package power dis-

sipation and the  $R_{DS}$  of the MOSFET at  $T_{J(MAX)}$ . The maximum  $R_{DS}$  of the MOSFET at  $T_{J(MAX)}$  is calculated by increasing the maximum room temperature  $R_{DS}$  by the  $R_{DS}$  temperature coefficient. The temperature coefficient ( $T_C$ ) is 2800ppm/°C. Therefore,

$$\text{MAX } R_{DS} 125^\circ\text{C} = R_{DS} 25^\circ\text{C} \times (1 + T_C \times \Delta T)$$

$$\text{MAX } R_{DS} 125^\circ\text{C} = 120\text{m}\Omega \times (1 + 0.0028 \times (125^\circ\text{C} - 25^\circ\text{C})) = 154\text{m}\Omega$$

For maximum current, refer to the following equation:

$$I_{OUT(MAX)} < \frac{P_{D(MAX)}}{R_{DS}}$$

For example, if  $V_{IN} = 5\text{V}$ ,  $R_{DS(MAX)} = 154\text{m}\Omega$  and  $T_A = 25^\circ\text{C}$ ,  $I_{OUT(MAX)} = 2.3\text{A}$ . If the output load current were to exceed 2.3A or if the ambient temperature were to increase, the internal die temperature would increase and the device would be damaged.

Higher peak currents can be obtained with the AAT4280A. To accomplish this, the device thermal resistance must be reduced by increasing the heat sink area or by operating the load switch in a duty-cycle manner.

### High Peak Output Current Applications

Some applications require the load switch to operate at a continuous nominal current level with short duration, high-current peaks. The duty cycle for both output current levels must be taken into account. To do so, first calculate the power dissipation at the nominal continuous current level, and then add in the additional power dissipation due to the short duration, high-current peak scaled by the duty factor.

For example, a 4V system using an AAT4280A operates at a continuous 100mA load current level and has short 2A current peaks, as in a GSM application. The current peak occurs for 576 $\mu\text{s}$  out of a 4.61ms period.

First, the current duty cycle is calculated:

$$\% \text{ Peak Duty Cycle: } X/100 = 576\mu\text{s}/4.61\text{ms}$$

$$\% \text{ Peak Duty Cycle} = 12.5\%$$

The load current is 100mA for 87.5% of the 4.61ms period and 2A for 12.5% of the period. Since the Electrical Characteristics do not report  $R_{DS(MAX)}$  for 4V operation, it must be calculated approximately by consulting the chart of  $R_{DS(ON)}$  vs.  $V_{IN}$ . The  $R_{DS}$  reported for 5V can be scaled by the ratio seen in the chart to derive the  $R_{DS}$  for a 4V  $V_{IN}$ :  $120\text{m}\Omega \times 87\text{m}\Omega / 80\text{m}\Omega = 130\text{m}\Omega$ . De-rated for temperature:  $130\text{m}\Omega \times (1 + 0.0028 \times (125^\circ\text{C} - 25^\circ\text{C})) = 166\text{m}\Omega$ . The power dissipation for a 100mA load is calculated as follows:

$$\begin{aligned} P_{D(MAX)} &= I_{OUT}^2 \times R_{DS} \\ P_{D(100\text{mA})} &= (100\text{mA})^2 \times 166\text{m}\Omega \\ P_{D(100\text{mA})} &= 1.66\text{mW} \\ P_{D(87.5\%D/C)} &= \%DC \times P_{D(100\text{mA})} \\ P_{D(87.5\%D/C)} &= 0.875 \times 1.66\text{mW} \\ P_{D(87.5\%D/C)} &= 1.45\text{mW} \end{aligned}$$

The power dissipation for 100mA load at 87.5% duty cycle is 1.45mW. Now the power dissipation for the remaining 12.5% of the duty cycle at 2A is calculated:

$$\begin{aligned} P_{D(MAX)} &= I_{OUT}^2 \times R_{DS} \\ P_{D(2A)} &= (2\text{A})^2 \times 166\text{m}\Omega \\ P_{D(2A)} &= 664\text{mW} \\ P_{D(12.5\%D/C)} &= \%DC \times P_{D(2A)} \\ P_{D(12.5\%D/C)} &= 0.125 \times 664\text{mW} \\ P_{D(12.5\%D/C)} &= 83\text{mW} \end{aligned}$$

The power dissipation for 2A load at 12.5% duty cycle is 83mW. Finally, the two power figures are summed to determine the total true power dissipation under the varied load:

$$\begin{aligned} P_{D(\text{total})} &= P_{D(100\text{mA})} + P_{D(2A)} \\ P_{D(\text{total})} &= 1.45\text{mW} + 83\text{mW} \\ P_{D(\text{total})} &= 84.5\text{mW} \end{aligned}$$

The maximum power dissipation for the AAT4280A operating at an ambient temperature of 85°C is 333mW. The device in this example will have a total power dissipation of 84.5mW. This is well within the thermal limits for safe operation of the device; in fact, at 85°C, the AAT4280A will handle a 2A pulse for up to 50% duty cycle. At lower ambient temperatures, the duty cycle can be further increased.

### Printed Circuit Board Layout Recommendations

For proper thermal management and to take advantage of the low  $R_{DS(ON)}$  of the AAT4280A, a few circuit board layout rules should be followed:  $V_{IN}$  and  $V_{OUT}$  should be routed using wider than normal traces, and GND should be connected to a ground plane. To maximize package thermal dissipation and power handling capacity of the AAT4280A SC70JW-8 package, the ground plane area connected to the ground pins should be made as large as possible. For best performance,  $C_{IN}$  and  $C_{OUT}$  should be placed close to the package pins.

### Evaluation Board Layout

The AAT4280A evaluation layout follows the printed circuit board layout recommendations and can be used for good applications layout. Refer to Figures 1 through 3.

Note: Board layout shown is not to scale.

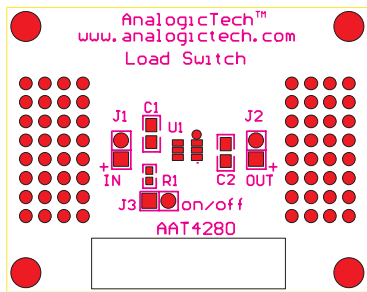

Figure 1: Evaluation Board Top Side Silk Screen Layout / Assembly Drawing.

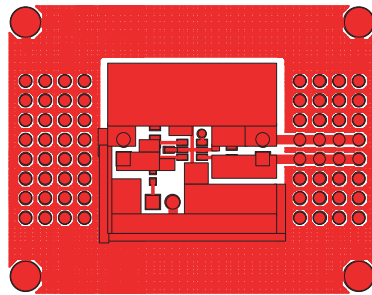

Figure 2: Evaluation Board Component Side Layout.

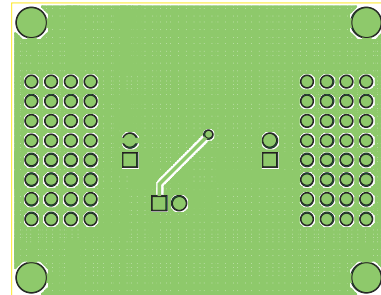

Figure 3: Evaluation Board Solder Side Layout.

### Ordering Information

Device Option	Package	Marking <sup>1</sup>	Part Number (Tape and Reel) <sup>2</sup>
AAT4280A-1	SC70JW-8	NDXY	<b>AAT4280AIJS-1-T1</b>
AAT4280A-2	SC70JW-8	NEXY	<b>AAT4280AIJS-2-T1</b>
AAT4280A-3	SC70JW-8	NFXY	<b>AAT4280AIJS-3-T1</b>



All AnalogicTech products are offered in Pb-free packaging. The term “Pb-free” means semiconductor products that are in compliance with current RoHS standards, including the requirement that lead not exceed 0.1% by weight in homogeneous materials. For more information, please visit our website at <http://www.analogictech.com/pbfree>.

### Package Information

#### SC70JW-8

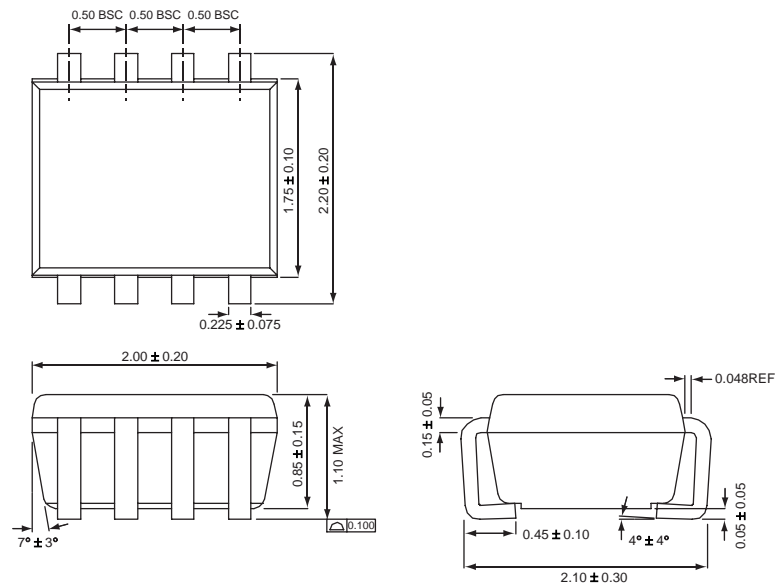

All dimensions in millimeters.

1. XYY = assembly and date code.  
2. Sample stock is generally held for part numbers listed in **BOLD**.

© Advanced Analogic Technologies, Inc.

AnalogicTech cannot assume responsibility for use of any circuitry other than circuitry entirely embodied in an AnalogicTech product. No circuit patent licenses, copyrights, mask work rights, or other intellectual property rights are implied. AnalogicTech reserves the right to make changes to their products or specifications or to discontinue any product or service without notice. Customers are advised to obtain the latest version of relevant information to verify, before placing orders, that information being relied on is current and complete. All products are sold subject to the terms and conditions of sale supplied at the time of order acknowledgement, including those pertaining to warranty, patent infringement, and limitation of liability. AnalogicTech warrants performance of its semiconductor products to the specifications applicable at the time of sale in accordance with AnalogicTech's standard warranty. Testing and other quality control techniques are utilized to the extent AnalogicTech deems necessary to support this warranty. Specific testing of all parameters of each device is not necessarily performed.

**Advanced Analogic Technologies, Inc.**  
**830 E. Arques Avenue, Sunnyvale, CA 94085**  
**Phone (408) 737-4600**  
**Fax (408) 737-4611**