



# AAT4282A

## Dual Slew Rate Controlled Load Switch

SmartSwitch™

### General Description

The AAT4282A SmartSwitch™ is a member of AnalogicTech's Application Specific Power MOSFET™ (ASPM™) product family. The AAT4282A is a dual P-channel MOSFET power switch designed for high-side load-switching applications. Each MOSFET has a typical  $R_{DS(ON)}$  of 60mΩ, allowing increased load switch current handling capacity with a low forward voltage drop. The device is available in three different versions with flexible turn-on and turn-off characteristics – from very fast to slew-rate limited. The standard 4282A (-1) version has a slew-rate limited turn-on load switch. The AAT4282A (-2) version features fast turn-on capability, typically less than 500ns turn-on and 3μs turn-off times. The AAT4282A (-3) variation offers a shutdown load discharge circuit to rapidly turn off a load circuit when the switch is disabled. An additional feature is a slew-rate selector pin which can switch between fast and slow slew rate.

All the AAT4282A load switch versions are designed to operate from 1.5V up to 6.5V, making them ideal for both 3V and 5V systems. Input logic levels are TTL and 2.5V to 5V CMOS compatible. The quiescent supply current is a very low 1μA.

The AAT4282A is available in the Pb-free, low profile 2.0x2.0mm FTDFN22-8 package and is specified over the -40 to 85°C temperature range.

### Features

- $V_{IN}$  Range: 1.5V to 6.5V
- Low  $R_{DS(ON)}$ 
  - 60mΩ Typical @ 5V
  - 140mΩ Typical @ 1.5V
- Slew Rate Turn-On Time Options
  - 1ms
  - 0.5μs
  - 100μs
- Fast Shutdown Load Discharge Option
- Low Quiescent Current
  - Typically 1μA
- TTL/CMOS Input Logic Level
- Temperature Range -40°C to 85°C
- FTDFN22-8 Package

### Applications

- Cellular Telephones
- Digital Still Cameras
- Hotswap Supplies
- Notebook Computers
- PDA Phones
- PDAs
- PMPs
- Smartphones

### Typical Application

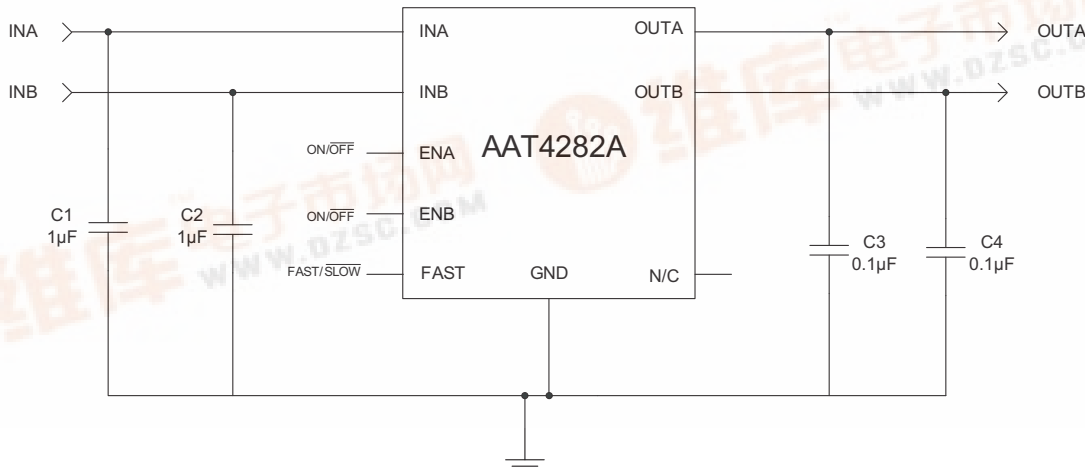

## Pin Descriptions

Pin #	Symbol	Function
1	INA	This is the pin to the P-channel MOSFET source for Switch A. Bypass to ground through a 1 $\mu$ F capacitor. INA is independent of INB
2	ENA	Active-High Enable Input A. A logic low turns the switch off and the device consumes less than 1 $\mu$ A of current. Logic high resumes normal operation.
3	ENB	Active-High Enable Input B. A logic low turns the switch off and the device consumes less than 1 $\mu$ A of current. Logic high resumes normal operation.
4	INB	This is the pin to the P-channel MOSFET source for Switch B. Bypass to ground through a 1 $\mu$ F capacitor. INB is independent of INA.
5	OUTB	This is the pin to the P-channel MOSFET drain connection. Bypass to ground through a 0.1 $\mu$ F capacitor.
6	GND	Ground connection
7	FAST	Active-high input Switches between FAST (Logic H) and SLOW (Logic L) Slew rate
8	OUTA	This is the pin to the P-channel MOSFET drain connection. Bypass to ground through a 0.1 $\mu$ F capacitor.

## Pin Configuration

**FTDFN22-8**  
**(Top View)**

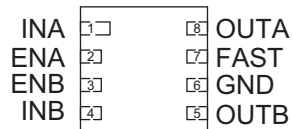

### Selector Guide

Part Number	Slew Rate (Typ)		Active Pull-Down	Enable
	FAST (H)	SLOW (L)		
AAT4282A-1*	1ms		NO	Active High
AAT4282A-2*	0.5 $\mu$ s		NO	Active High
AAT4282A-3	100 $\mu$ s	1ms	YES	Active High

### Absolute Maximum Ratings<sup>1</sup>

Symbol	Description	Value	Units
$V_{IN}$	IN to GND	-0.3 to 7	V
$V_{EN, FAST}$	EN, FAST to GND	-0.3 to 7	V
$V_{OUT}$	OUT to GND	-0.3 to $V_{IN} + 0.3$	V
$I_{MAX}$	Maximum Continuous Switch Current	3	A
$I_{DM}$	Maximum Pulsed Current	Duty Cycle $\leq$ 10% 5.5	A
$T_J$	Operating Junction Temperature Range	-40 to 150	$^{\circ}$ C
$T_{LEAD}$	Maximum Soldering Temperature (at leads)	300	$^{\circ}$ C
$V_{ESD}$	ESD Rating <sup>2</sup> – HBM	4000	V

### Thermal Characteristics<sup>3</sup>

Symbol	Description	Value	Units
$\theta_{JA}$	Thermal Resistance	70	$^{\circ}$ C/W
$P_D$	Maximum Power Dissipation	1.78	W

1. Stresses above those listed in Absolute Maximum Ratings may cause permanent damage to the device. Functional operation at conditions other than the operating conditions specified is not implied. Only one Absolute Maximum Rating should be applied at any one time.  
 2. Human body model is a 100pF capacitor discharged through a 1.5k $\Omega$  resistor into each pin.  
 3. Mounted on a AAT4282A demo board in still 25 $^{\circ}$ C air.

### Electrical Characteristics<sup>1</sup>

$V_{IN} = 5V$ ,  $T_A = -40$  to  $85^\circ C$  unless otherwise noted. Typical values are at  $T_A = 25^\circ C$ . Per channel.

Symbol	Description	Conditions	Min	Typ	Max	Units
<b>AAT4282A All Versions</b>						
$V_{IN}$	Operation Voltage		1.5		6.5	V
$I_Q$	Quiescent Current	ON/OFF = ACTIVE, FAST = $V_{IN}$ , $I_{OUT} = 0$			1.0	$\mu A$
$I_{Q(OFF)}$	Off Supply Current	ON/OFF = Inactive, OUT = Open			1.0	$\mu A$
$I_{SD(OFF)}$	Off Switch Current	ON/OFF = GND, $V_{OUT} = 0$			1.0	$\mu A$
$R_{DS(ON)}$	On-Resistance A or B	$V_{IN} = 6.5V$		56		m $\Omega$
		$V_{IN} = 5V$		60	130	
		$V_{IN} = 4.2V$		65	140	
		$V_{IN} = 3.0V$		76	160	
		$V_{IN} = 1.80V$		110	230	
		$V_{IN} = 1.5V$		140	280	
$TCR_{RDS}$	On Resistance Temperature Coefficient			2800		ppm/ $^\circ C$
$V_{IL}$	ON/OFF Input Logic Low Voltage	$V_{IN} = 1.5V$			0.4	V
$V_{IH}$	ON/OFF Input Logic High Voltage	$V_{IN} = 5V$	1.4			V
$I_{SINK}$	ON/OFF Input Leakage	$V_{ON/OFF} = 5.5V$			1.0	$\mu A$
<b>AAT4282A -1<sup>2</sup></b>						
$T_{D(ON)}$	Output Turn-On Delay Time	$V_{IN} = 5V$ , $R_{LOAD} = 10\Omega$ , $T_A = 25^\circ C$		20	40	$\mu s$
$T_{ON}$	Turn-On Rise Time	$V_{IN} = 5V$ , $R_{LOAD} = 10\Omega$ , $T_A = 25^\circ C$		1000	1500	$\mu s$
$T_{D(OFF)}$	Output Turn-OFF Delay Time	$V_{IN} = 5V$ , $R_{LOAD} = 10\Omega$ , $T_A = 25^\circ C$		4.0	10	$\mu s$
<b>AAT4282A -2<sup>2</sup></b>						
$T_{D(ON)}$	Output Turn-On Delay Time	$V_{IN} = 5V$ , $R_{LOAD} = 10\Omega$ , $T_A = 25^\circ C$		0.5	2	$\mu s$
$T_{ON}$	Turn-On Rise Time	$V_{IN} = 5V$ , $R_{LOAD} = 10\Omega$ , $T_A = 25^\circ C$		0.5	1.0	$\mu s$
$T_{D(OFF)}$	Output Turn-OFF Delay Time	$V_{IN} = 5V$ , $R_{LOAD} = 10\Omega$ , $T_A = 25^\circ C$		4.0	10	$\mu s$
<b>AAT4282A -3</b>						
$T_{D(ON)}$	Output Turn-On Delay Time	$V_{IN} = 5V$ , $R_{LOAD} = 10\Omega$ , $T_A = 25^\circ C$		20	40	$\mu s$
$T_{ON}$	Turn-On Rise Time	$V_{IN} = 5V$ , $R_{LOAD} = 10\Omega$ , FAST = 5V, $T_A = 25^\circ C$		100	150	$\mu s$
$T_{ON}$	Turn-On Rise Time	$V_{IN} = 5V$ , $R_{LOAD} = 10\Omega$ , FAST = 0V, $T_A = 25^\circ C$		1000	1500	$\mu s$
$T_{D(OFF)}$	Output Turn-OFF Delay Time	$V_{IN} = 5V$ , $R_{LOAD} = 10\Omega$ , $T_A = 25^\circ C$		4.0	10	$\mu s$
$R_{PD}$	Output Pull-Down Resistance During OFF	ON/OFF = Inactive, $T_A = 25^\circ C$		150	250	$\Omega$

1. The AAT4282A is guaranteed to meet performance specifications over the  $-40^\circ C$  to  $+85^\circ C$  operating temperature range and is assured by design, characterization, and correlation with statistical process controls.  
2. Contact factory for other turn on and delay options.

### Typical Characteristics

$V_{IN} = 5V$ ,  $T_A = 25^\circ C$  unless otherwise noted.

**Quiescent Current vs. Temperature**  
(No Load; Single Switch)

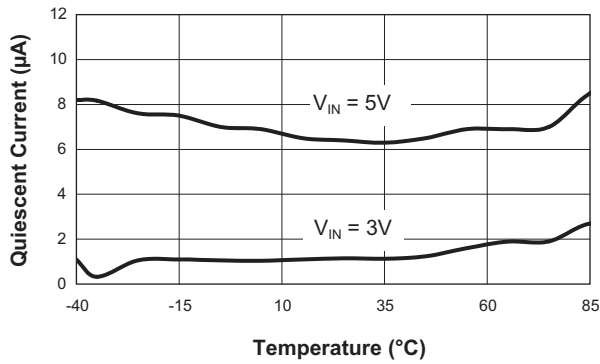

**Quiescent Current vs. Input Voltage**  
(No Load; Single Switch)

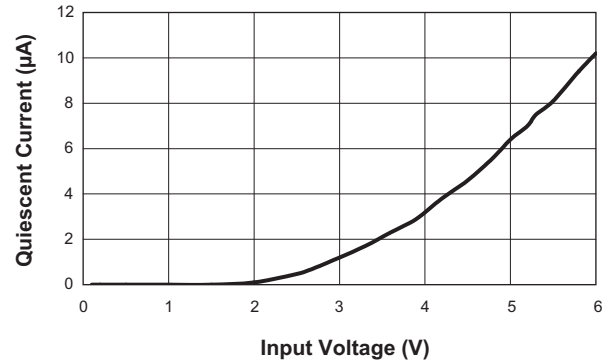

**Off Supply Current vs. Temperature**  
(No Load; EN = GND;  $V_{IN} = 5V$ )

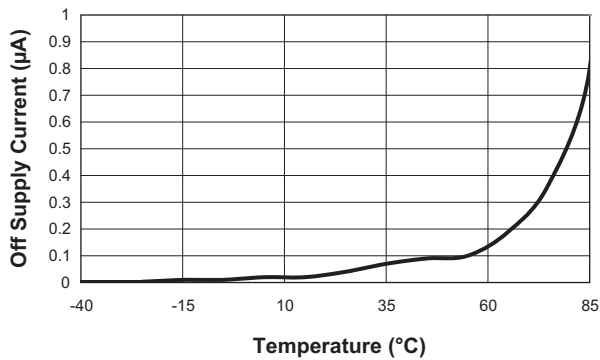

**Typical ON/OFF Threshold vs. Input Voltage**

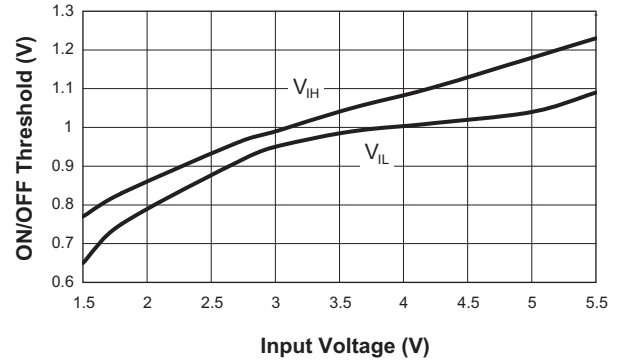

**On-Resistance vs. Temperature**

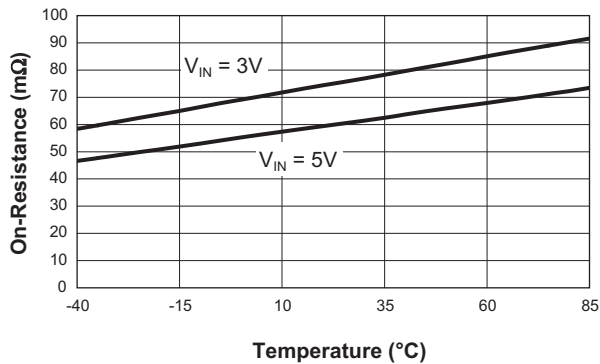

**On-Resistance vs. Input Voltage**

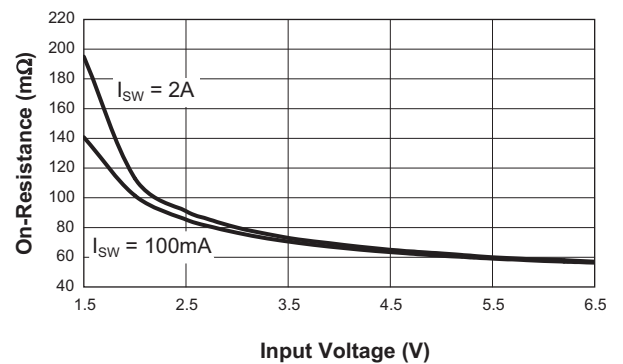

### Typical Characteristics

$V_{IN} = 5V$ ,  $T_A = 25^\circ C$  unless otherwise noted.

**Output Turn-On Delay Time**  
 $(V_{INA}/V_{ENA} = 5V; V_{INB}/V_{ENB} = 3V; R_{LA} = 10\Omega; R_{LB} = 20\Omega)$

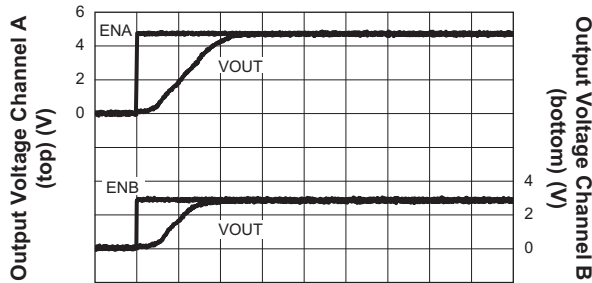

Time (50 $\mu$ s/div)

**Output Turn-On Delay Time**  
 $(V_{INA}/V_{INB}/V_{EN} = 5V; R_L = 10\Omega)$

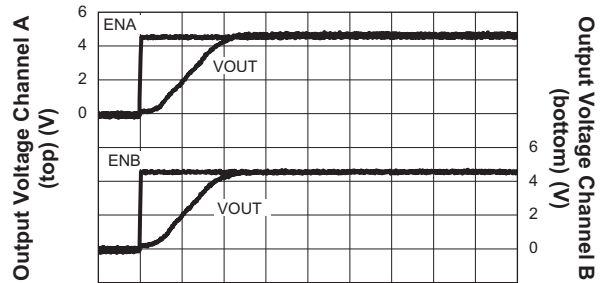

Time (50 $\mu$ s/div)

**Output Turn-On Delay Time**  
 $(V_{IN} = 5V; R_L = 10\Omega)$

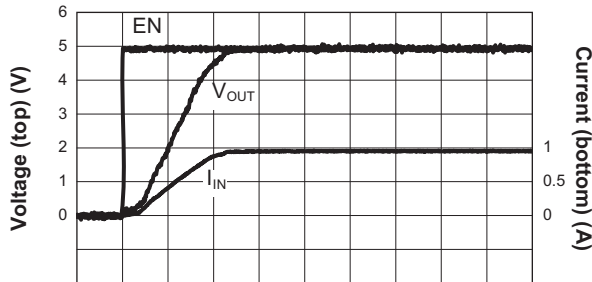

Time (50 $\mu$ s/div)

**Output Turn-On Delay Time**  
 $(V_{IN} = 3V; R_L = 20\Omega)$

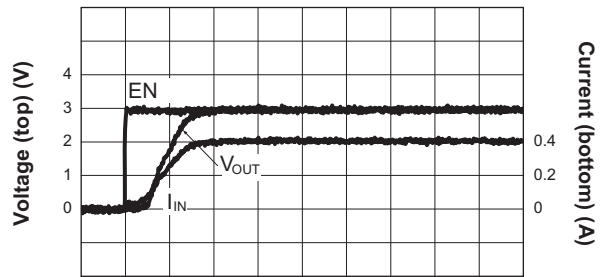

Time (50 $\mu$ s/div)

**Output Turn-On**  
 $(R_L = 10\Omega)$

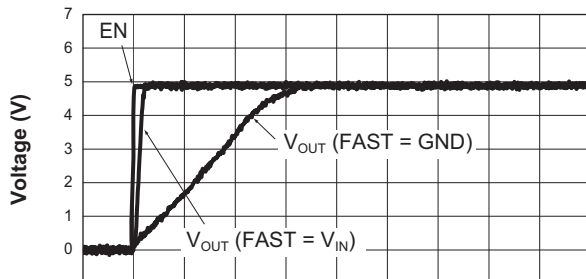

Time (500 $\mu$ s/div)

**Output Turn-On**  
 $(V_{IN} = 1.8V; R_L = 10\Omega)$

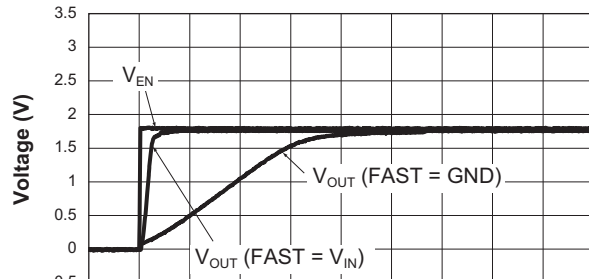

Time (200 $\mu$ s/div)

### Typical Characteristics

$V_{IN} = 5V$ ,  $T_A = 25^\circ C$  unless otherwise noted.

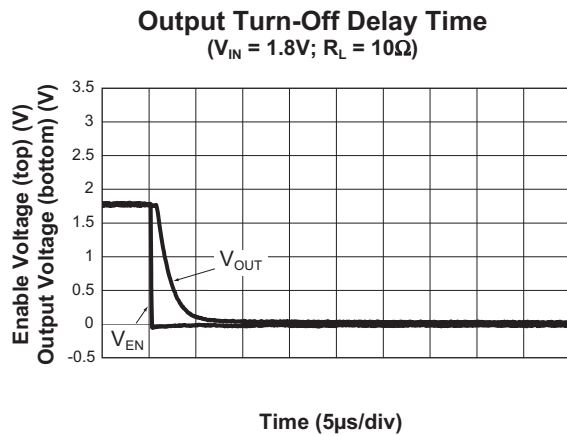
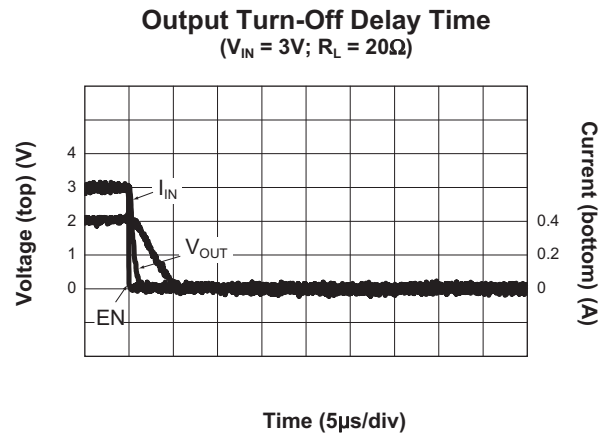
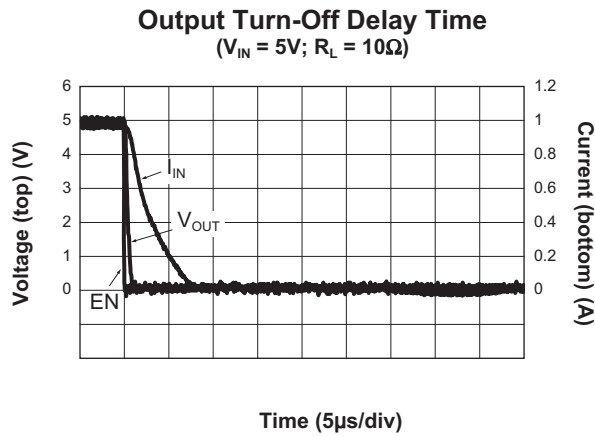

### Functional Block Diagram

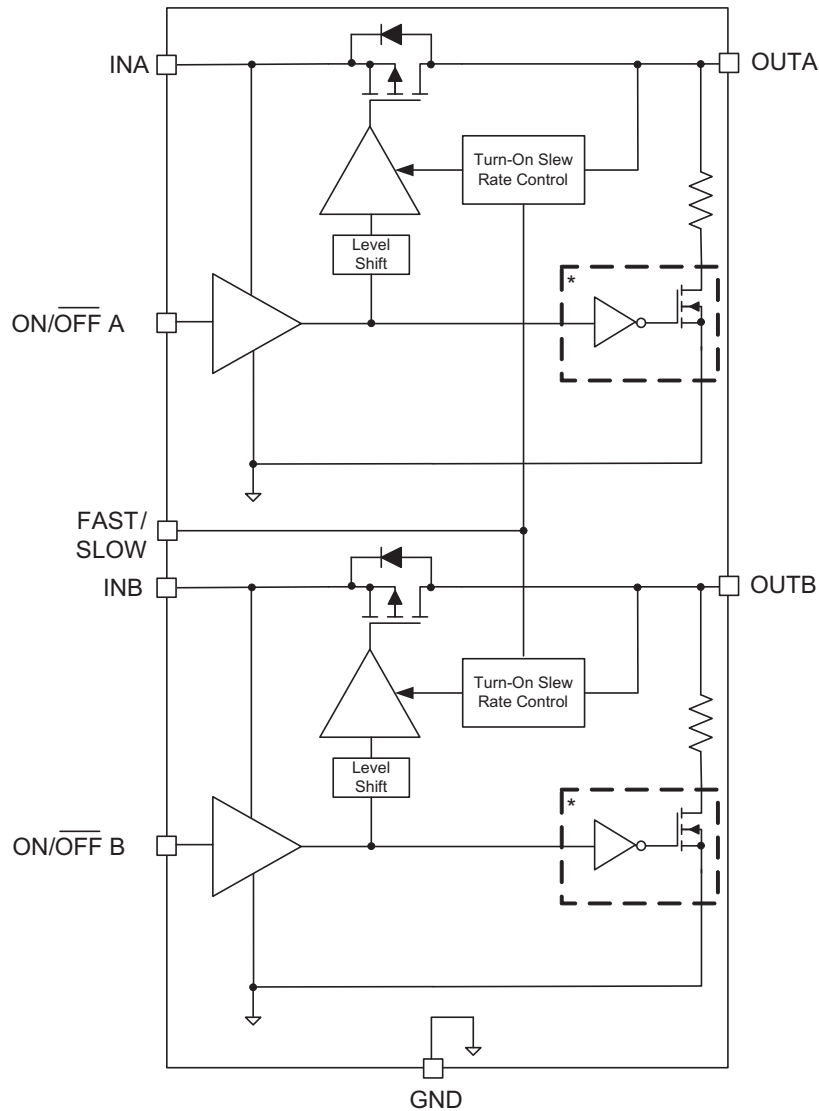

\* AAT4282A-3 version only

### Functional Description

The AAT4282A is a family of flexible dual P-channel MOSFET power switches designed for high-side load switching applications. There are three versions of the AAT4282A with different turn-on and turn-off characteristics to choose from, depending upon the specific requirements of an

application. The first version, the AAT4282A-1, has a moderate turn-on slew rate feature, which reduces in-rush current when the MOSFET is turned on. This function allows the load switch to be implemented with either a small input capacitor or no input capacitor at all. During turn-on slewing, the current ramps linearly until it reaches the level required for the output load condition. The



proprietary turn-on current control method works by careful control and monitoring of the MOSFET gate voltage. When the device is switched ON, the gate voltage is quickly increased to the threshold level of the MOSFET. Once at this level, the current begins to slew as the gate voltage is slowly increased until the MOSFET becomes fully enhanced. Once it has reached this point the gate is quickly increased to the full input voltage and the  $R_{DS(ON)}$  is minimized.

The second version, the AAT4282A-2, is a very fast switch intended for high-speed switching applications.

This version has no turn-on slew rate control and no special output discharge features. The final switch version, the AAT4282A-3, has the addition of a minimized slew rate limited turn-on function and a shutdown output discharge circuit to rapidly turn off a load when the load switch is disabled through the ON/OFF pin. Using the FAST input pin on the AAT4282A-3, the device can be manually switched to a slower slew rate.

All versions of the AAT4282A operate with input voltages ranging from 1.5V to 6.5V. All versions of this device have extremely low operating current, making them ideal for battery-powered applications.

The ON/OFF control pin is TTL compatible and will also function with 2.5V to 5V logic systems, making the AAT4282A an ideal level-shifting load switch.

## Applications Information

### Input Capacitor

A 1 $\mu$ F or larger capacitor is typically recommended for  $C_{IN}$  in most applications. A  $C_{IN}$  capacitor is not required for basic operation; however, it is useful in preventing load transients from affecting upstream circuits.  $C_{IN}$  should be located as close to the device VIN pin as practically possible. Ceramic, tantalum, or aluminum electrolytic capacitors may be selected for  $C_{IN}$ . There is no specific capacitor equivalent series resistance (ESR) requirement for  $C_{IN}$ . However, for higher current operation, ceramic capacitors are recommended for  $C_{IN}$  due to their inherent capability over tantalum capacitors to withstand input current surges from low-impedance sources, such as batteries in portable devices.

### Output Capacitor

For proper slew operation, a 0.1 $\mu$ F capacitor or greater is required between VOUT and GND. Likewise, with the output capacitor, there is no specific capacitor ESR requirement. If desired,  $C_{OUT}$  may be increased without limit to accommodate any load transient condition without adversely affecting the slew rate.

### Enable Function

The AAT4282A features an enable / disable function. This pin (ON) is active high and is compatible with TTL or CMOS logic. To assure the load switch will turn on, the ON control level must be greater than 1.4V. The load switch will go into shutdown mode when the voltage on the ON pin falls below 0.4V. When the load switch is in shutdown mode, the OUT pin is tri-stated, and quiescent current drops to leakage levels below 1 $\mu$ A.

### Reverse Output-to-Input Voltage Conditions and Protection

Under normal operating conditions, a parasitic diode exists between the output and input of the load switch. The input voltage should always remain greater than the output load voltage, maintaining a reverse bias on the internal parasitic diode. Conditions where  $V_{OUT}$  might exceed  $V_{IN}$  should be avoided since this would forward bias

the internal parasitic diode and allow excessive current flow into the V<sub>OUT</sub> pin, possibly damaging the load switch. In applications where there is a possibility of V<sub>OUT</sub> exceeding V<sub>IN</sub> for brief periods of time during normal operation, the use of a larger value C<sub>IN</sub> capacitor is highly recommended. A larger value of C<sub>IN</sub> with respect to C<sub>OUT</sub> will effect a slower C<sub>IN</sub> decay rate during shutdown, thus preventing V<sub>OUT</sub> from exceeding V<sub>IN</sub>. In applications where there is a greater danger of V<sub>OUT</sub> exceeding V<sub>IN</sub> for extended periods of time, it is recommended to place a Schottky diode from V<sub>IN</sub> to V<sub>OUT</sub> (connecting the cathode to V<sub>IN</sub> and anode to V<sub>OUT</sub>). The Schottky diode forward voltage should be less than 0.45V.

### Thermal Considerations and High Output Current Applications

The AAT4282A is designed to deliver a continuous output load current. The limiting characteristic for maximum safe operating output load current is package power dissipation. In order to obtain high operating currents, careful device layout and circuit operating conditions must be taken into account.

The following discussions will assume the load switch is mounted on a printed circuit board utilizing the minimum recommended footprint as stated in the Printed Circuit Board Layout Recommendations section of this datasheet.

At any given ambient temperature (T<sub>A</sub>), the maximum package power dissipation can be determined by the following equation:

$$P_{D(MAX)} = \frac{T_{J(MAX)} - T_A}{\theta_{JA}}$$

Constants for the AAT4282A are maximum junction temperature (T<sub>J(MAX)</sub> = 125°C) and package thermal resistance (θ<sub>JA</sub> = 70°C/W). Worst case conditions are calculated at the maximum operating temperature, T<sub>A</sub> = 85°C. Typical conditions are calculated under normal ambient conditions where T<sub>A</sub> = 25°C. At T<sub>A</sub> = 85°C, P<sub>D(MAX)</sub> = 571mW. At T<sub>A</sub> = 25°C, P<sub>D(MAX)</sub> = 1429mW.

The maximum continuous output current for the AAT4282A is a function of the package power dissipation and the R<sub>DS</sub> of the MOSFET at T<sub>J(MAX)</sub>. The maximum R<sub>DS</sub> of the MOSFET at T<sub>J(MAX)</sub> is calculated by increasing the maximum room temperature R<sub>DS</sub> by the R<sub>DS</sub> temperature coefficient. The temperature coefficient (TC) is 2800ppm/°C. Therefore, at 125°C:

$$R_{DS(MAX)} = R_{DS(25^\circ C)} : (1 + TC \cdot \Delta T)\Omega$$

$$R_{DS(MAX)} = 130m\Omega \cdot + 0.002800 \cdot (125^\circ C - 25^\circ C))$$

$$R_{DS(MAX)} = 166.4m\Omega$$

For maximum current, refer to the following equation:

$$I_{OUT(MAX)} < \sqrt{\frac{P_{D(MAX)}}{R_{DS}}}$$

For example, if V<sub>IN</sub> = 5V, R<sub>DS(MAX)</sub> = 166.4mΩ, and T<sub>A</sub> = 25°C, I<sub>OUT(MAX)</sub> = 2.93A. If the output load current were to exceed 2.93A or if the ambient temperature were to increase, the internal die temperature would increase and the device would be damaged. Higher peak currents can be obtained with the AAT4282A. To accomplish this, the device thermal resistance must be reduced by increasing the heat sink area or by operating the load switch in a duty cycle manner. Duty cycles with peaks less than 2ms in duration can be considered using the method described in the High Peak Current Applications section of this datasheet.

1 The actual maximum junction temperature of AAT4282A is 150°C. However, good designed practice is to derate the maximum die temperature down to 125 °C to prevent the possibility of over-temperature damage.

### High Peak Output Current Applications

Some applications require the load switch to operate at a continuous nominal current level with short duration, high-current peaks. Refer to the  $I_{DM}$  specification in the Absolute Maximum Ratings table to ensure the AAT4282A's maximum pulsed current rating is not exceeded. The duty cycle for both output current levels must be taken into account. To do so, first calculate the power dissipation at the nominal continuous current level, and then add the additional power dissipation due to the short duration, high-current peak scaled by the duty factor. For example, a 4V system using an AAT4282A which has channel A operates at a continuous 1A load current level, and channel B operates at a continuous 100mA load current level and has short 3A current peaks, as in a GSM application. The current peak occurs for 576 $\mu$ s out of a 4.61ms period. First, the current duty cycle is calculated:

$$\% \text{ Peak Duty Cycle} = \left( \frac{x}{100} \right) = \left( \frac{576\mu\text{s}}{4.61\text{ms}} \right)$$

$$\% \text{ Peak Duty Cycle} = 12.5\%$$

The load current is 100mA for 87.5% of the 4.61ms period and 3A for 12.5% of the period. Since the Electrical Characteristics do not report  $R_{DS(MAX)}$  for 4V operation, it must be approximated by consulting the chart of  $R_{DS(ON)}$  vs.  $V_{IN}$ . The  $R_{DS}$  reported for 5V at 100mA and 3A can be scaled by the ratio seen in the chart to derive the  $R_{DS}$  for 4V  $V_{IN}$  at 25°C:  $130\text{m}\Omega \cdot 63\text{m}\Omega / 60\text{m}\Omega = 136.5\text{m}\Omega$ . Derated for temperature:  $136.5\text{m}\Omega \cdot (1 + 0.002800 \cdot (125^\circ\text{C} - 25^\circ\text{C})) = 174.7\text{m}\Omega$ .

For channel A, the power dissipation for a continuous 1A load is calculated as follows:

$$P_{D(CHA)} = I_{OUT}^2 \cdot R_{DS} = (1\text{A})^2 \cdot 174.7\text{m}\Omega = 174.7\text{mW}$$

For channel B, the power dissipation for 100mA load is calculated as follows:

$$P_{D(MAX)} = I_{OUT}^2 \cdot R_{DS}$$

$$P_{D(100\text{mA})} = (100\text{mA})^2 \cdot 174.7\text{m}\Omega$$

$$P_{D(100\text{mA})} = 1.75\text{mW}$$

$$P_{D(87.5\%D/C)} = \%DC \cdot P_{D(100\text{mA})}$$

$$P_{D(87.5\%D/C)} = 0.875 \cdot 1.75\text{mW}$$

$$P_{D(87.5\%D/C)} = 1.53\text{mW}$$

The power dissipation for 100mA load at 87.5% duty cycle is 1.53mW. Now the power dissipation for the remaining 12.5% of the duty cycle at 3A is calculated:

$$P_{D(MAX)} = I_{OUT}^2 \cdot R_{DS}$$

$$P_{D(3A)} = (3\text{A})^2 \cdot 174.7\text{m}\Omega$$

$$P_{D(3A)} = 1572\text{mW}$$

$$P_{D(12.5\%D/C)} = \%DC \cdot P_{D(3A)}$$

$$P_{D(12.5\%D/C)} = 0.125 \cdot 1572\text{mW}$$

$$P_{D(12.5\%D/C)} = 196.7\text{mW}$$

Finally, the total power dissipation for channels A and B is determined as follows:

$$P_{D(total)} = P_{D(CHA)} + P_{D(100\text{mA})} + P_{D(3A)}$$

$$P_{D(total)} = 174.7\text{mW} + 1.53\text{mW} + 196.7\text{mW}$$

$$P_{D(total)} = 373\text{mW}$$

The maximum power dissipation for the AAT4282A operating at an ambient temperature of 85°C is 373mW. The device in this example will have a total power dissipation of 571mW. This is well within the thermal limits for safe operation of the device; in fact, at 85°C, the AAT4282A will handle a 3A pulse for up to 25% duty cycle. At lower ambient temperatures, the duty cycle can be further increased.

### Printed Circuit Board Layout Recommendations

For proper thermal management, and to take advantage of the low  $R_{DS(ON)}$  of the AAT4282A, a few circuit board layout rules should be followed:  $V_{IN}$  and  $V_{OUT}$  should be routed using wider than normal traces, and GND should be connected to a ground plane. For best performance,  $C_{IN}$  and  $C_{OUT}$  should be placed close to the package pins.

### Evaluation Board Layout

The AAT4282A evaluation layout follows the printed circuit board layout recommendations and can be used for good applications layout. Refer to Figures 1 through 2.

Note: Board layout shown is not to scale.

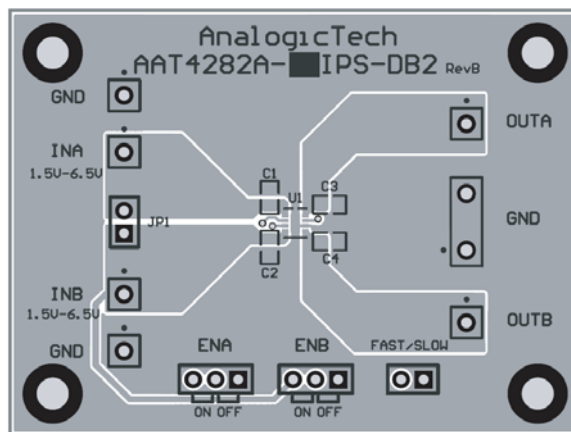

Figure 1: Evaluation Board Top Side Layout.

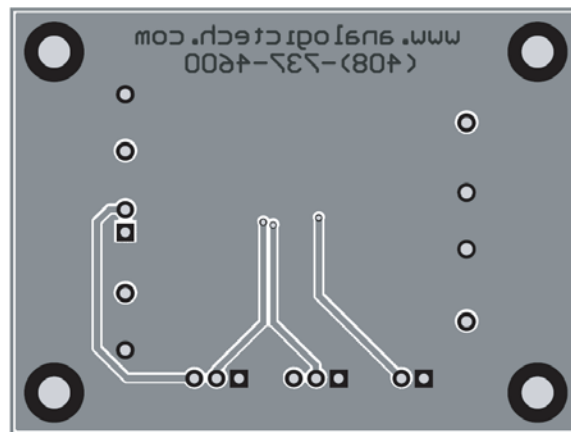

Figure 2: Evaluation Board Bottom Side Layout.

### Ordering Information

Device Option	Package	Marking <sup>1</sup>	Part Number (Tape and Reel) <sup>2</sup>
AAT4282A-3	FTDFN22-8	WKXYY	AAT4282AIPS-3-T1



All AnalogicTech products are offered in Pb-free packaging. The term “Pb-free” means semiconductor products that are in compliance with current RoHS standards, including the requirement that lead not exceed 0.1% by weight in homogeneous materials. For more information, please visit our website at <http://www.analogictech.com/pbfree>.

### Package Information<sup>3</sup>

#### FTDFN22-8

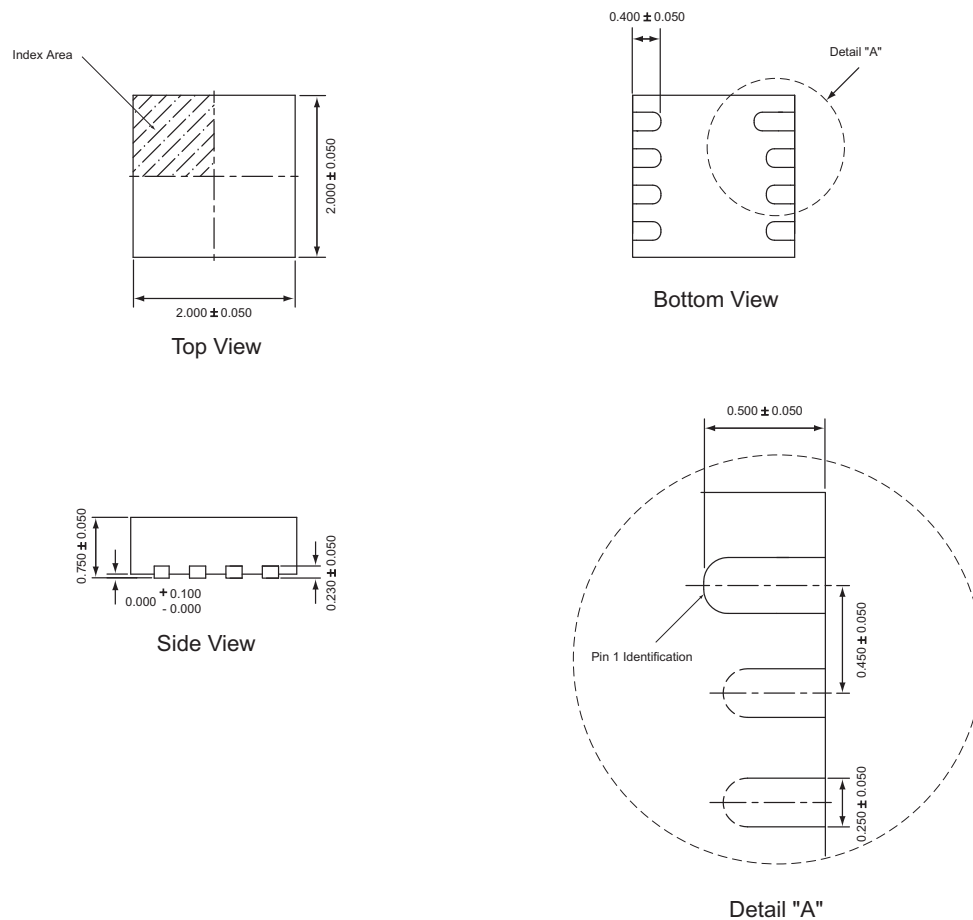

All dimensions in millimeters.

1. XYY = assembly and date code.
2. Sample stock is generally held on part numbers listed in **BOLD**.
3. The leadless package family, which includes QFN, TQFN, DFN, FTDFN, TDFN and STDFN, has exposed copper (unplated) at the end of the lead terminals due to the manufacturing process. A solder fillet at the exposed copper edge cannot be guaranteed and is not required to ensure a proper bottom solder connection.



# AAT4282A

## Dual Slew Rate Controlled Load Switch

---

© Advanced Analogic Technologies, Inc.

AnalogicTech cannot assume responsibility for use of any circuitry other than circuitry entirely embodied in an AnalogicTech product. No circuit patent licenses, copyrights, mask work rights, or other intellectual property rights are implied. AnalogicTech reserves the right to make changes to their products or specifications or to discontinue any product or service without notice. Except as provided in AnalogicTech's terms and conditions of sale, AnalogicTech assumes no liability whatsoever, and AnalogicTech disclaims any express or implied warranty relating to the sale and/or use of AnalogicTech products including liability or warranties relating to fitness for a particular purpose, merchantability, or infringement of any patent, copyright or other intellectual property right. In order to minimize risks associated with the customer's applications, adequate design and operating safeguards must be provided by the customer to minimize inherent or procedural hazards. Testing and other quality control techniques are utilized to the extent AnalogicTech deems necessary to support this warranty. Specific testing of all parameters of each device is not necessarily performed. AnalogicTech and the AnalogicTech logo are trademarks of Advanced Analogic Technologies Incorporated. All other brand and product names appearing in this document are registered trademarks or trademarks of their respective holders.

**Advanced Analogic Technologies, Inc.**  
3230 Scott Boulevard, Santa Clara, CA 95054  
Phone (408) 737-4600  
Fax (408) 737-4611

