



ACST4

AC power switch

Main applications

- AC static switching in appliance control systems
- Drive of low power high inductive or resistive loads like
 - spray pump in dishwashers
 - fan in air-conditioners

Features

- Blocking voltage: $V_{DRM} / V_{RRM} = \pm 700\text{ V}$
- Avalanche controlled: $V_{CL\ typ} = 1100\text{ V}$
- Nominal conducting current : $I_{T(RMS)} = 4\text{ A}$
- High surge current capability: 30 A for 20 ms full wave
- Gate triggering current: $I_{GT} < 10\text{ mA}$ or 25 mA
- Switch integrated driver
- High noise immunity: static $dV/dt > 500\text{ V}/\mu\text{s}$

Benefits

- Enables equipment to meet IEC 61000-4-5
- High off-state reliability with planar technology
- No external overvoltage protection needed
- Reduces the power component factor
- Interfaces directly with the microcontroller
- Direct interface with the microcontroller for the ACST4-7S ($I_{GT} < 10\text{ mA}$)

Description

The ACST4 belongs to the AC power switch family built around the ASD™ technology. This high performance device is adapted to home appliances or industrial systems and drives loads up to 4 A.

The ACS™ switch embeds a Triac structure with a high voltage clamping device to absorb the inductive turn-off energy and withstand line transients such as those described in the IEC 61000-4-5 standards.

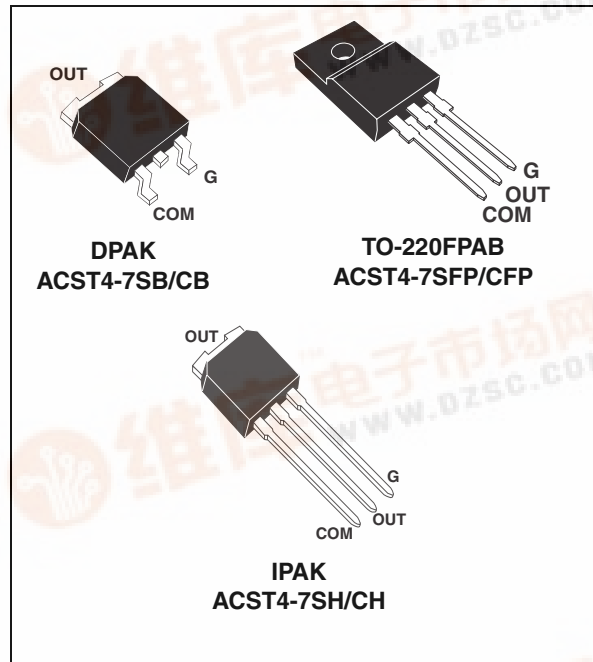
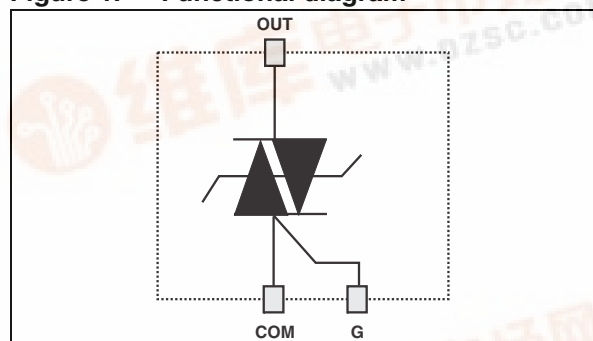

Figure 1. Functional diagram



TM: ASD and ACS are trademarks of STMicroelectronics.



1 Characteristics

Table 1. Absolute ratings (limiting values)
For either positive or negative polarity of pin OUT voltage in respect to pin COM voltage

Symbol	Parameter		Value	Unit	
V_{DRM}/V_{RRM}	Repetitive peak off-state voltage		$T_j = -10^\circ\text{C}$	700	V
$I_{T(RMS)}$	RMS on-state current full cycle sine wave 50 to 60 Hz	DPAK, IPAK	$T_c = 110^\circ\text{C}$	4	A
		TO-220FPAB	$T_c = 100^\circ\text{C}$		
I_{TSM}	Non repetitive surge peak on-state current		$F = 50\text{ Hz}$	30	A
	T_j initial = 25°C , full cycle sine wave		$F = 60\text{ Hz}$	33	A
I^2t	Fusing capability		$t_p = 10\text{ ms}$	6.4	A^2s
di/dt	Repetitive on-state current critical rate of rise $I_G = 10\text{ mA}$ ($t_r < 100\text{ ns}$)	$T_j = 125^\circ\text{C}$	$F = 120\text{ Hz}$	50	$\text{A}/\mu\text{s}$
V_{PP}	Non repetitive line peak pulse voltage ⁽¹⁾			2	kV
T_{stg}	Storage temperature range			- 40 to + 150	$^\circ\text{C}$
T_j	Operating junction temperature range			- 30 to + 125	$^\circ\text{C}$
T_l	Maximum lead soldering temperature during 10 s			260	$^\circ\text{C}$

1. according to test described by IEC 61000-4-5 standard and [Figure 3](#).

Table 2. Gate characteristics (maximum values)

Symbol	Parameter	Value	Unit
$P_{G(AV)}$	Average gate power dissipation	0.1	W
P_{GM}	Peak gate power dissipation ($t_p = 20\ \mu\text{s}$)	10	A
I_{GM}	Peak gate current ($t_p = 20\ \mu\text{s}$)	1	V

Table 3. Thermal resistances

Symbol	Parameter		Value	Unit
$R_{th(j-a)}$	Junction to ambient	$S^{(1)} = 0.5\text{ cm}^2$ DPAK, IPAK	70	$^\circ\text{C}/\text{W}$
		TO-220FPAB	60	$^\circ\text{C}/\text{W}$
$R_{th(j-l)}$	Junction to tab/lead for full cycle sine wave conduction	DPAK, IPAK	2.6	$^\circ\text{C}/\text{W}$
		TO-220FPAB	4.6	$^\circ\text{C}/\text{W}$

1. S = Copper surface under Tab

Table 4. Parameter description

Parameter symbol	Parameter description
I_{GT}	Triggering gate current
V_{GT}	Triggering gate voltage
V_{GD}	Non-triggering gate voltage
I_H	Holding current
I_L	Latching current
V_{TM}	Peak on-state voltage drop
V_{TO}	On state threshold voltage
R_d	On state dynamic resistance
I_{DRM} / I_{RRM}	Maximum forward or reverse leakage current
dV/dt	Critical rate of rise of off-state voltage
$(dV/dt)_c$	Critical rate of rise of commutating off-state voltage
$(dI/dt)_c$	Critical rate of decrease of commutating on-state current
V_{CL}	Clamping voltage
I_{CL}	Clamping current

Table 5. Electrical characteristics

For either positive or negative polarity of pin OUT voltage respect to pin COM voltage

Symbol	Test conditions				ACST4-7S	ACST4-7C	Unit
I_{GT}	$V_{OUT} = 12\text{ V DC}$ $R_L = 33\ \Omega$	QI - QII - QIII	$T_j = 25^\circ\text{ C}$	MAX	10	25	mA
V_{GT}	$V_{OUT} = 12\text{ V DC}$ $R_L = 33\ \Omega$	QI - QII - QIII	$T_j = 25^\circ\text{ C}$	MAX	1	1.1	V
V_{GD}	$V_{OUT} = V_{DRM}$	$R_L = 3.3\ \Omega$	$T_j = 125^\circ\text{ C}$	MIN	0.2		V
I_H	$I_{OUT} = 100\text{ mA}$	Gate open	$T_j = 25^\circ\text{ C}$	MAX	20	35	mA
I_L	$I_G = 2 \times I_{GTmax}$		$T_j = 25^\circ\text{ C}$	MAX	40	60	mA
V_{TM}	$I_{OUT} = 5.6\text{ A}$	$t_p = 380\ \mu\text{s}$	$T_j = 25^\circ\text{ C}$	MAX	1.5		V
V_{TO}			$T_j = 125^\circ\text{ C}$	MAX	0.90		V
R_d			$T_j = 125^\circ\text{ C}$	MAX	100		m Ω
I_{DRM} / I_{RRM}	$V_{OUT} = 700\text{ V}$		$T_j = 25^\circ\text{ C}$	MAX	10		μA
			$T_j = 125^\circ\text{ C}$	MAX	500		
dV/dt	$V_{OUT} = 460\text{ V}$	Gate open	$T_j = 110^\circ\text{ C}$	MIN	200	500	V/ μs
$(dI/dt)_c$	$(dI/dt)_c = 15\text{ V}/\mu\text{s}$		$T_j = 125^\circ\text{ C}$	MIN	2.0	2.5	A/ms
V_{CL}	$I_{CL} = 1\text{ mA}$	$t_p = 1\text{ ms}$	$T_j = 25^\circ\text{ C}$	TYP	1100		V

2 AC line switch basic application

The ACST4 device has been designed to switch on and off low power, but highly inductive or resistive loads such as dishwashers spray pumps, and air-conditioners fan.

- **Pin COM:** Common drive reference to connect to the power line neutral
- **Pin G:** Switch Gate input to connect to the digital controller
- **Pin OUT:** Switch Output to connect to the load

ACST4-7S triggering current has to be sunk from the gate pin G. The switch can then be driven directly by logic level circuits through a resistor as shown on the typical application diagram .

Thanks to its thermal and turn off commutation performances, the ACST4 switch is able to drive with no turn off additional snubber an inductive load up to 4 A.

Figure 2. Typical application diagram

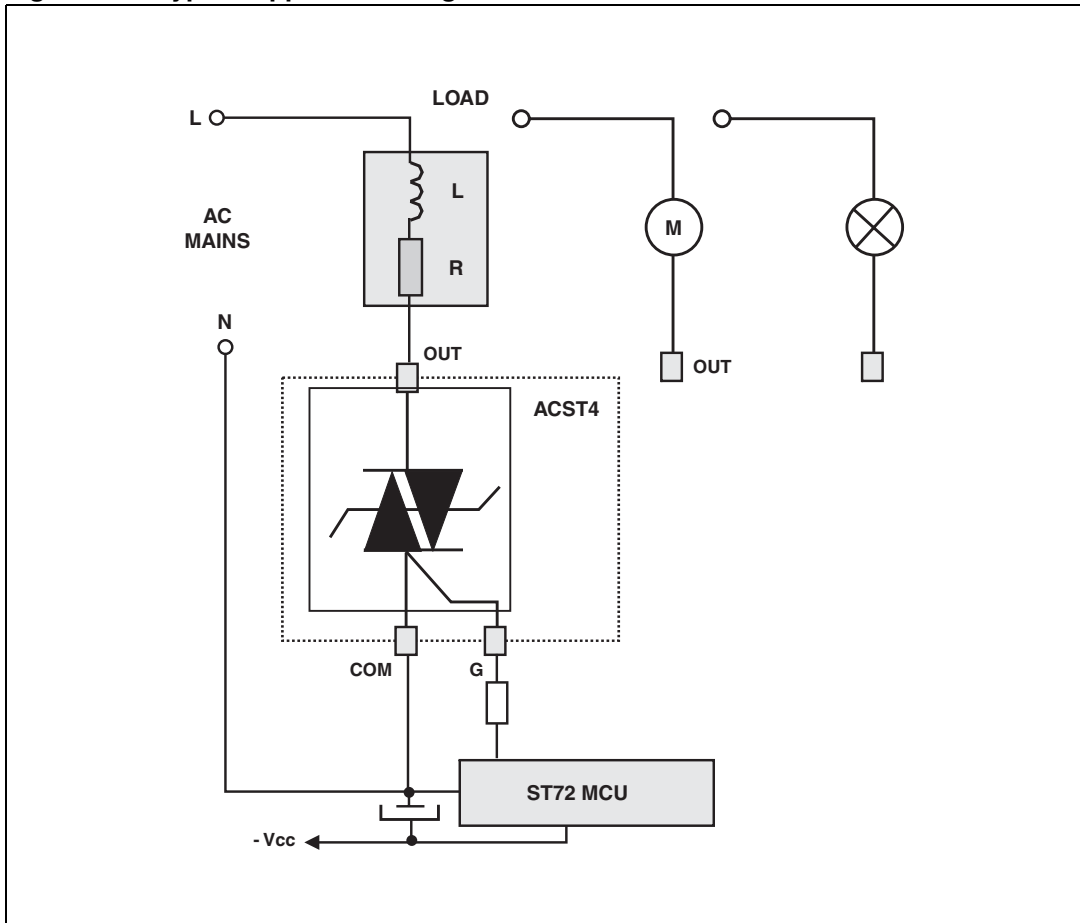

3 AC line transient voltage ruggedness

The ACST4 switch is able to sustain safely the AC line transient voltages either by clamping the low energy spikes or by breaking over under high energy shocks, even with high turn-on current rises.

The test circuit of the *Figure 6* is representative of the final ACST application and is also used to stress the ACST switch according to the IEC 61000-4-5 standard conditions. Thanks to the load, the ACST switch sustains the voltage spikes up to 2 kV above the peak line voltage. It will break over safely even on resistive load where the turn on current rate of rise, is as high as shown on *Figure 7*. Such non-repetitive test can be done 10 times on each AC line voltage polarity.

Figure 3. Overvoltage ruggedness test circuit for resistive and inductive loads according to IEC 61000-4-5 standards.
 $R = 150 \Omega$, $L = 10 \mu\text{H}$, $V_{PP} = 2 \text{ kV}$.

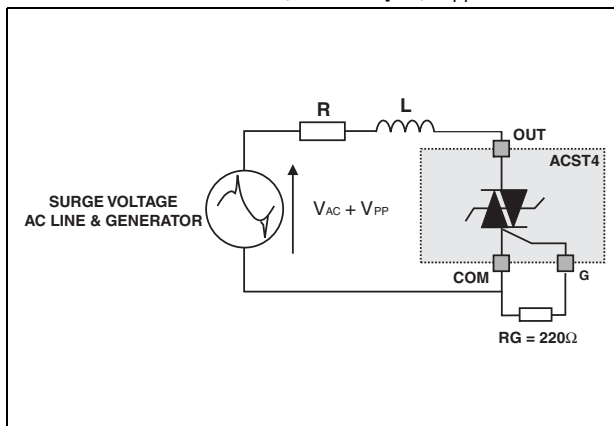

Figure 4. Current and voltage of the ACST4 during IEC 61000-4-5 standard test with R, L and V_{PP} .

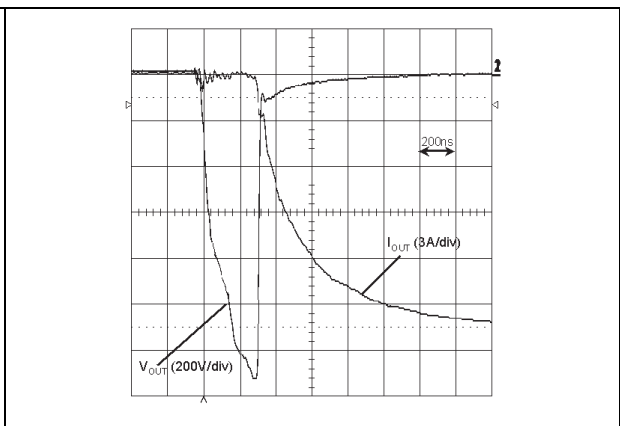

Figure 5. Maximum power dissipation versus RMS on-state current.

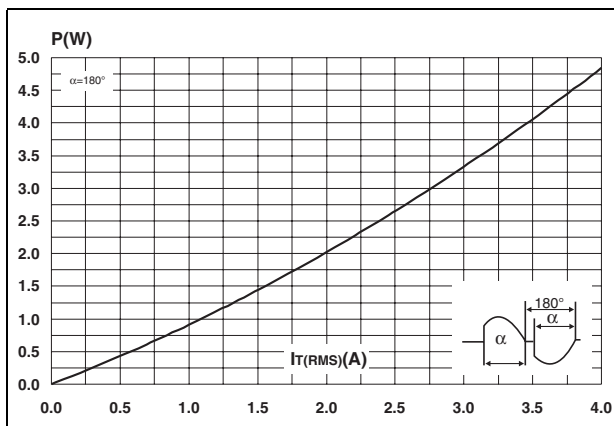

Figure 6. RMS on-state current versus case temperature.

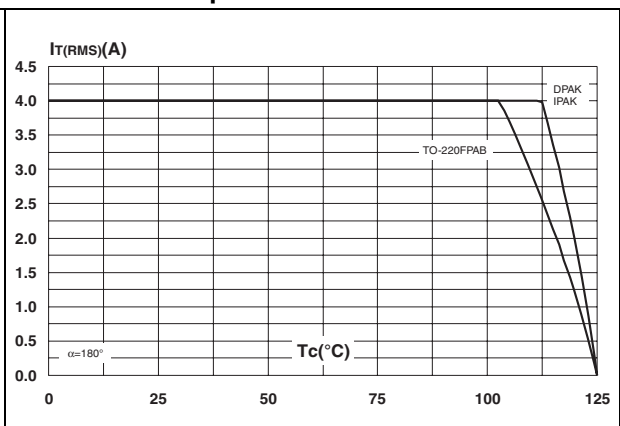

Figure 7. RMS on-state current versus ambient temperature.

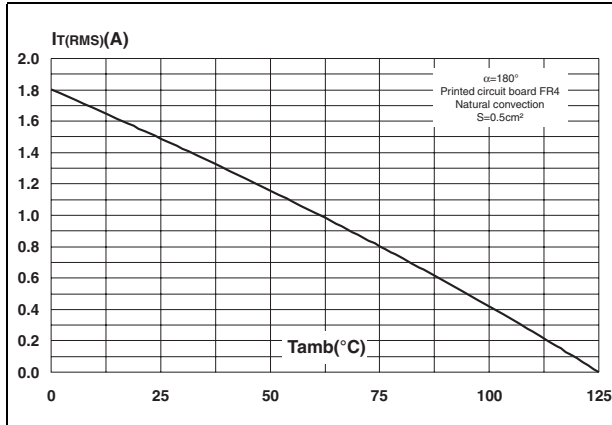

Figure 8. Relative variation of thermal impedance versus pulse duration.

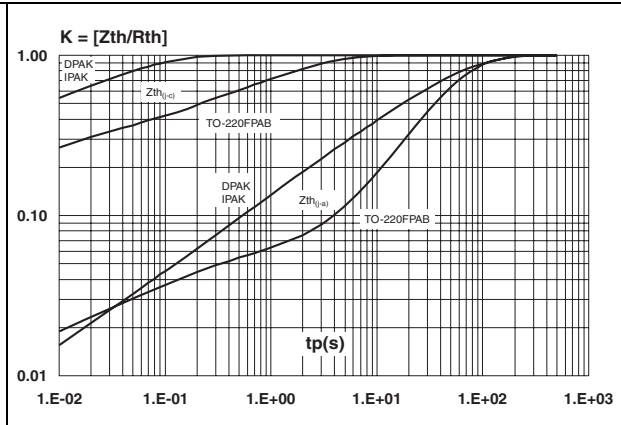

Figure 9. Relative variation of gate trigger current, holding current and latching versus junction temperature (typical values).

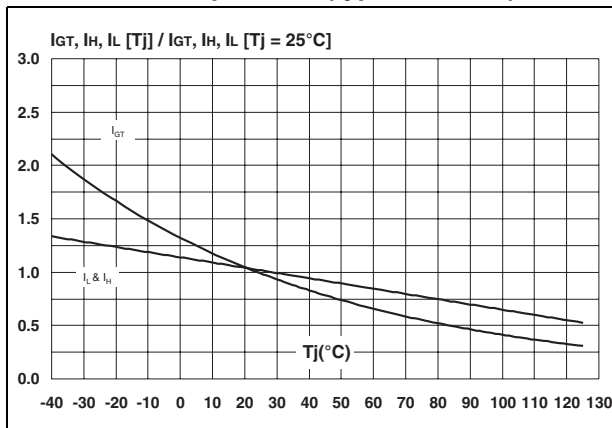

Figure 10. Relative variation of static dV/dt versus junction temperature.

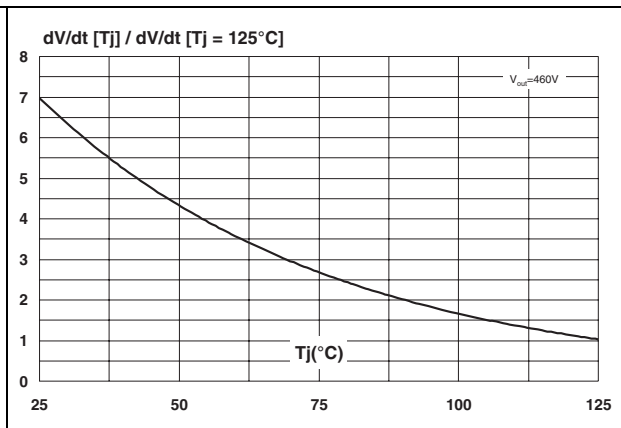

Figure 11. Relative variation of critical rate of decrease of main current versus reapplied dV/dt (typical values).

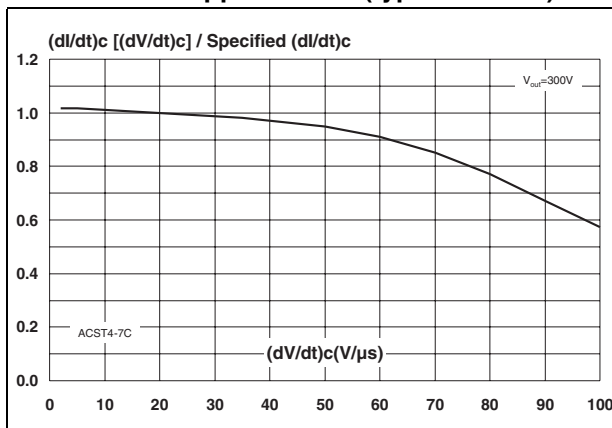

Figure 12. Relative variation of critical rate of decrease of main current versus reapplied dV/dt (typical values).

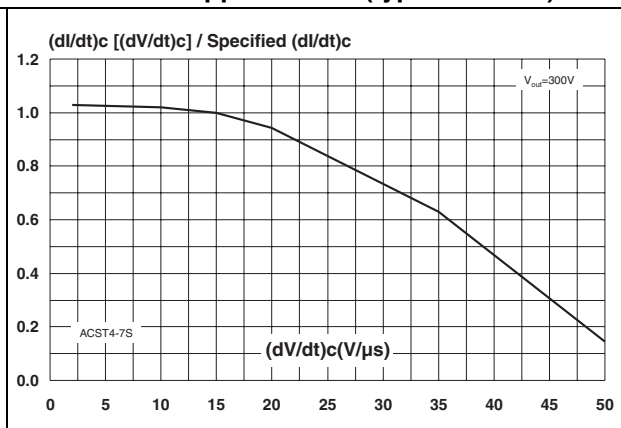

Figure 13. Relative variation of critical rate of decrease of main current versus junction temperature.

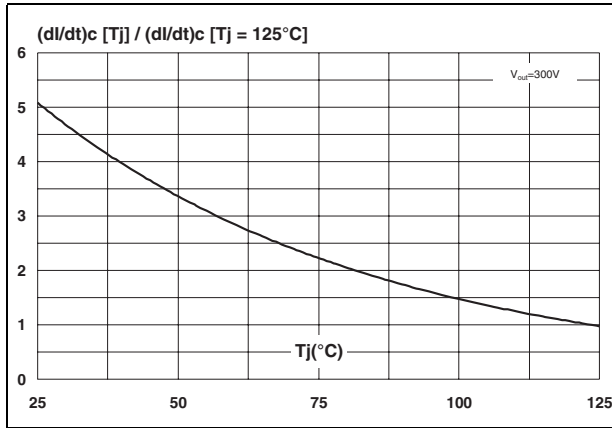

Figure 14. Surge peak on-state current versus number of cycles.

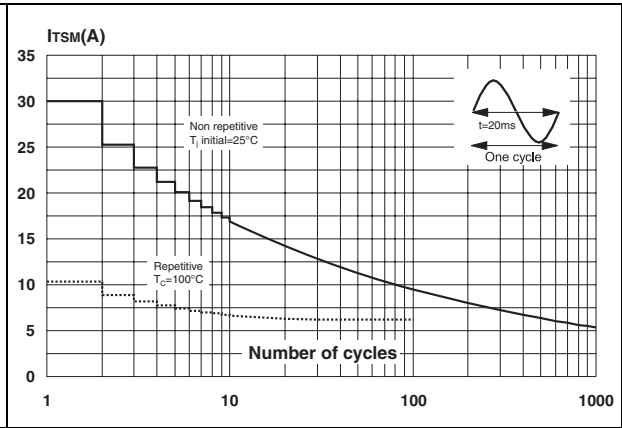

Figure 15. Non repetitive surge peak on-state current for a sinusoidal pulse with width $t_p < 10\text{ ms}$, and corresponding value of I^2t .

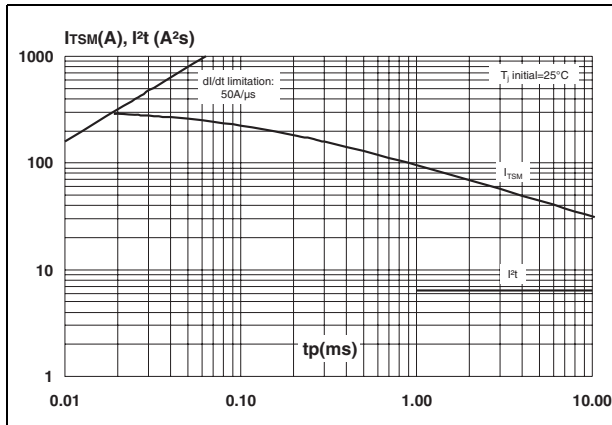

Figure 16. On-state characteristics (maximum values).

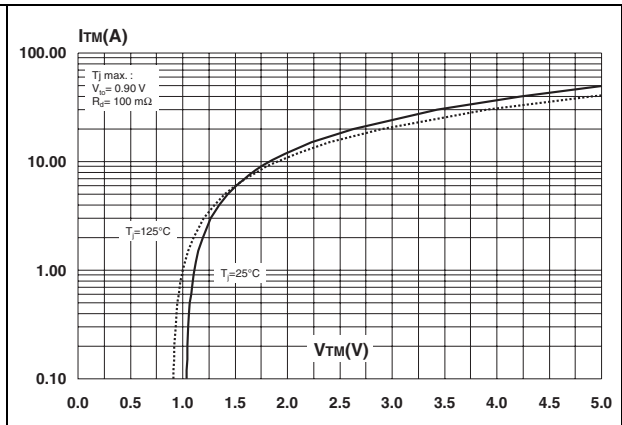
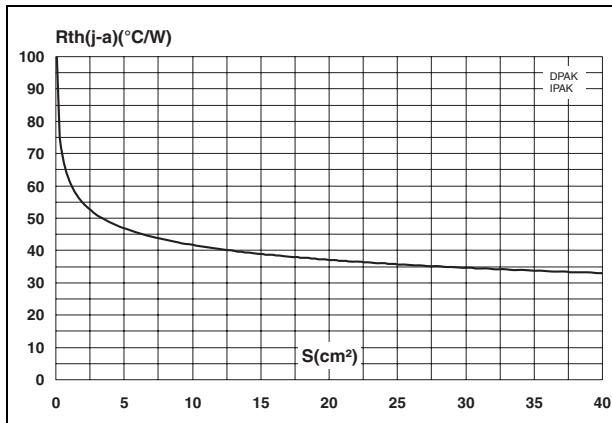
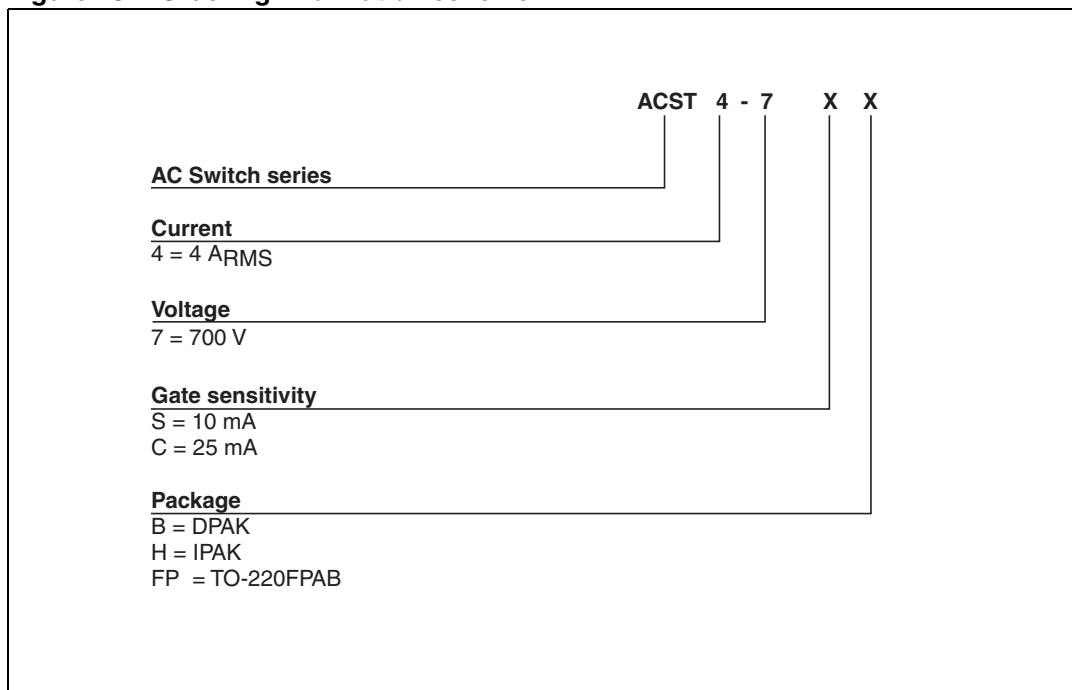

Figure 17. Thermal resistance junction to ambient versus copper surface under tab (printed circuit board FR4, copper thickness: 35 μm).



4 Ordering information scheme

Figure 18. Ordering information scheme



5 Package information

- Epoxy meets UL94, V0
- Recommended torque values 0.4 to 0.6 Nm

Table 6. DPAK dimensions

Ref.	Dimensions			
	Millimeters		Inches	
	Min.	Max.	Min.	Max.
A	2.20	2.40	0.086	0.094
A1	0.90	1.10	0.035	0.043
A2	0.03	0.23	0.001	0.009
B	0.64	0.90	0.025	0.035
B2	5.20	5.40	0.204	0.212
C	0.45	0.60	0.017	0.023
C2	0.48	0.60	0.018	0.023
D	6.00	6.20	0.236	0.244
E	6.40	6.60	0.251	0.259
G	4.40	4.60	0.173	0.181
H	9.35	10.10	0.368	0.397
L2	0.80 typ.		0.031 typ.	
L4	0.60	1.00	0.023	0.039
V2	0°	8°	0°	8°

Figure 19. Footprint (dimensions in mm)

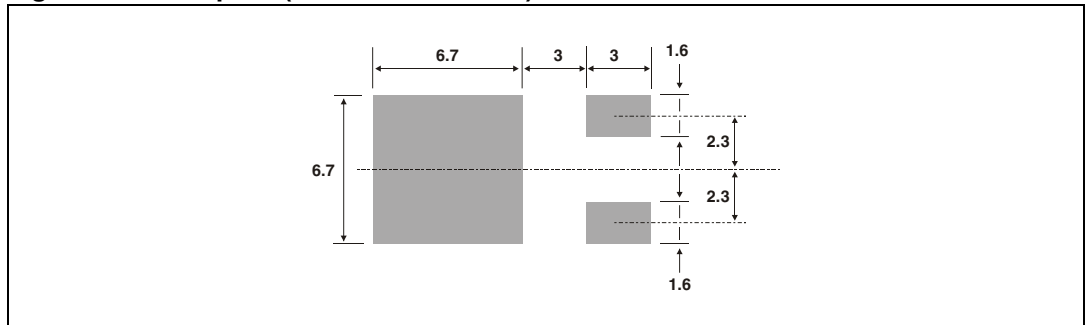
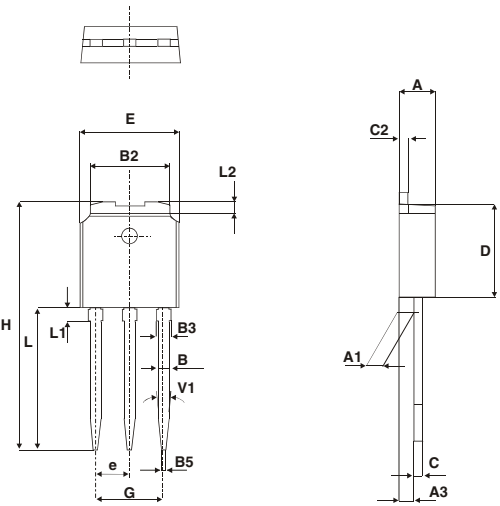

Table 7. IPAK dimensions



Ref.	Dimensions					
	Millimeters			Inches		
	Min.	Typ.	Max.	Min.	Typ.	Max.
A	2.20		2.40	0.086		0.094
A1	0.90		1.10	0.035		0.043
A3	0.70		1.30	0.027		0.051
B	0.64		0.90	0.025		0.035
B2	5.20		5.40	0.204		0.212
B3			0.95			0.037
B5		0.30			0.035	
C	0.45		0.60	0.017		0.023
C2	0.48		0.60	0.019		0.023
D	6		6.20	0.236		0.244
E	6.40		6.60	0.252		0.260
e		2.28			0.090	
G	4.40		4.60	0.173		0.181
H		16.10			0.634	
L	9		9.40	0.354		0.370
L1	0.8		1.20	0.031		0.047
L2		0.80	1		0.031	0.039
V1		10°			10°	

Table 8. TO-220FPAB dimensions

Ref.	Dimensions			
	Millimeters		Inches	
	Min.	Max.	Min.	Max.
A	4.4	4.6	0.173	0.181
B	2.5	2.7	0.098	0.106
D	2.5	2.75	0.098	0.108
E	0.45	0.70	0.018	0.027
F	0.75	1	0.030	0.039
F1	1.15	1.70	0.045	0.067
F2	1.15	1.70	0.045	0.067
G	4.95	5.20	0.195	0.205
G1	2.4	2.7	0.094	0.106
H	10	10.4	0.393	0.409
L2	16 Typ.		0.63 Typ.	
L3	28.6	30.6	1.126	1.205
L4	9.8	10.6	0.386	0.417
L5	2.9	3.6	0.114	0.142
L6	15.9	16.4	0.626	0.646
L7	9.00	9.30	0.354	0.366
Dia.	3.00	3.20	0.118	0.126

In order to meet environmental requirements, ST offers these devices in ECOPACK® packages. These packages have a lead-free second level interconnect. The category of second level interconnect is marked on the package and on the inner box label, in compliance with JEDEC Standard JESD97. The maximum ratings related to soldering conditions are also marked on the inner box label. ECOPACK is an ST trademark. ECOPACK specifications are available at: www.st.com.

6 Ordering information

Table 9. Ordering information

Part number	Marking	Package	Weight	Base qty	Packing mode
ACST4-7SB	ACST47S	DPAK	0.3 g	75	Tube
ACST4-7SB-TR	ACST47S	DPAK	0.3 g	2500	Tape and reel
ACST4-7SH	ACST47S	IPAK	0.4 g	75	Tube
ACST4-7SFP	ACST47S	TO-220FPAB	2.4 g	50	Tube
ACST4-7CB	ACST47C	DPAK	0.3 g	75	Tube
ACST4-7CB-TR	ACST47C	DPAK	0.3 g	2500	Tape and reel
ACST4-7CH	ACST47C	IPAK	0.4 g	75	Tube
ACST4-7CFP	ACST47C	TO-220FPAB	2.4 g	50	Tube

7 Revision history

Table 10. Revision history

Date	Revision	Changes
Jan-2003	3A	Previous update
04-Jul-2007	4	Reformatted to current standard. Added IPAK package

Please Read Carefully:

Information in this document is provided solely in connection with ST products. STMicroelectronics NV and its subsidiaries ("ST") reserve the right to make changes, corrections, modifications or improvements, to this document, and the products and services described herein at any time, without notice.

All ST products are sold pursuant to ST's terms and conditions of sale.

Purchasers are solely responsible for the choice, selection and use of the ST products and services described herein, and ST assumes no liability whatsoever relating to the choice, selection or use of the ST products and services described herein.

No license, express or implied, by estoppel or otherwise, to any intellectual property rights is granted under this document. If any part of this document refers to any third party products or services it shall not be deemed a license grant by ST for the use of such third party products or services, or any intellectual property contained therein or considered as a warranty covering the use in any manner whatsoever of such third party products or services or any intellectual property contained therein.

UNLESS OTHERWISE SET FORTH IN ST'S TERMS AND CONDITIONS OF SALE ST DISCLAIMS ANY EXPRESS OR IMPLIED WARRANTY WITH RESPECT TO THE USE AND/OR SALE OF ST PRODUCTS INCLUDING WITHOUT LIMITATION IMPLIED WARRANTIES OF MERCHANTABILITY, FITNESS FOR A PARTICULAR PURPOSE (AND THEIR EQUIVALENTS UNDER THE LAWS OF ANY JURISDICTION), OR INFRINGEMENT OF ANY PATENT, COPYRIGHT OR OTHER INTELLECTUAL PROPERTY RIGHT.

UNLESS EXPRESSLY APPROVED IN WRITING BY AN AUTHORIZED ST REPRESENTATIVE, ST PRODUCTS ARE NOT RECOMMENDED, AUTHORIZED OR WARRANTED FOR USE IN MILITARY, AIR CRAFT, SPACE, LIFE SAVING, OR LIFE SUSTAINING APPLICATIONS, NOR IN PRODUCTS OR SYSTEMS WHERE FAILURE OR MALFUNCTION MAY RESULT IN PERSONAL INJURY, DEATH, OR SEVERE PROPERTY OR ENVIRONMENTAL DAMAGE. ST PRODUCTS WHICH ARE NOT SPECIFIED AS "AUTOMOTIVE GRADE" MAY ONLY BE USED IN AUTOMOTIVE APPLICATIONS AT USER'S OWN RISK.

Resale of ST products with provisions different from the statements and/or technical features set forth in this document shall immediately void any warranty granted by ST for the ST product or service described herein and shall not create or extend in any manner whatsoever, any liability of ST.

ST and the ST logo are trademarks or registered trademarks of ST in various countries.

Information in this document supersedes and replaces all information previously supplied.

The ST logo is a registered trademark of STMicroelectronics. All other names are the property of their respective owners.

© 2007 STMicroelectronics - All rights reserved

STMicroelectronics group of companies

Australia - Belgium - Brazil - Canada - China - Czech Republic - Finland - France - Germany - Hong Kong - India - Israel - Italy - Japan - Malaysia - Malta - Morocco - Singapore - Spain - Sweden - Switzerland - United Kingdom - United States of America

www.st.com