



1700 MHz to 2400 MHz GaAs Matched RF PA Predriver

ADL5323

FEATURES

- Internally matched to 50 Ω input and output
- Internally biased
- Operating frequency: 1700 MHz to 2400 MHz
- Gain: 20 dB
- OIP3: 43 dBm
- P1 dB: 28 dBm
- Noise figure: 5 dB
- 3 mm \times 3 mm LFCSP
- Power supply: 5 V

APPLICATIONS

CDMA2000, WCDMA, and GSM base station transceivers and high power amplifiers

GENERAL DESCRIPTION

The ADL5323 is a high linearity GaAs driver amplifier that is internally matched to 50 Ω for operation in the 1700 MHz to 2400 MHz frequency range. The amplifier, which has a gain of 20 dB, has been specially designed for use in the output stage of a cellular base station radio or as an input preamplifier in a multicarrier base station power amplifier. Matching and biasing are all on-chip. The ADL5323 is available in a Pb-free, 3 mm \times 3 mm, 8-lead LFCSP with an operating temperature of -40°C to +85°C.

FUNCTIONAL BLOCK DIAGRAM

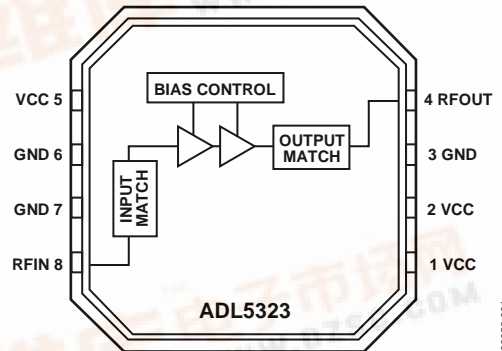

Figure 1.

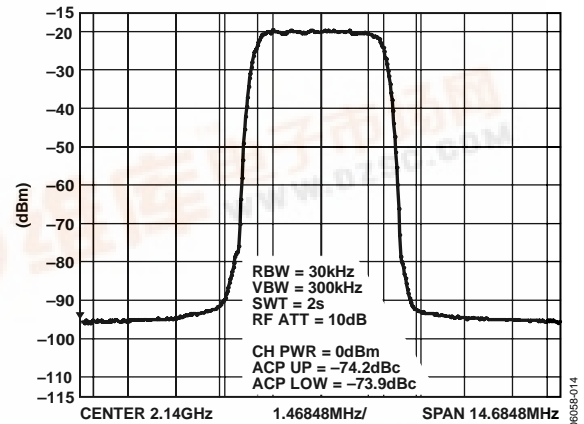

Figure 2. Single-Carrier WCDMA Spectral Plot @ 2140 MHz
(No Noise Floor Correction, Test Model 1-64)



TABLE OF CONTENTS

Features	1	Pin Configuration and Function Descriptions.....	5
Applications.....	1	Typical Performance Characteristics	6
Functional Block Diagram	1	Basic Connections	8
General Description	1	WCDMA Driving Application	8
Revision History	2	Evaluation Board	9
Specifications.....	3	Outline Dimensions	10
Absolute Maximum Ratings.....	4	Ordering Guide	10
ESD Caution.....	4		

REVISION HISTORY

7/06—Revision 0: Initial Version

SPECIFICATIONS

$V_{CC} = 5\text{ V}$, $T_A = 25^\circ\text{C}$.

Table 1.

Parameter	Conditions	Min	Typ	Max	Unit
FREQUENCY RANGE		1700		2400	MHz
GAIN	Frequency = 1960 MHz	18	20.5	24	dB
vs. Frequency	1930 MHz to 1990 MHz		± 0.2		dB
vs. Temperature	-40°C to $+85^\circ\text{C}$		± 1.25		dB
vs. Voltage	4.75 V to 5.25 V		± 0.1		dB
	Frequency = 2140 MHz	17.5	19.5	21.8	dB
vs. Frequency	2110 MHz to 2170 MHz		± 0.25		dB
vs. Temperature	-40°C to $+85^\circ\text{C}$		± 1.5		dB
vs. Voltage	4.75 V to 5.25 V		± 0.1		dB
P1 dB	Frequency = 1960 MHz	27.3	28		dBm
vs. Frequency	1930 MHz to 1990 MHz		± 0.1		dBm
vs. Temperature	-40°C to $+85^\circ\text{C}$		± 0.8		dBm
vs. Voltage	5 V, @ 5% (4.75 V to 5.25 V)		± 0.5		dBm
	Frequency = 2140 MHz	27.3	28		dBm
vs. Frequency	2110 MHz to 2170 MHz		± 0.15		dBm
vs. Temperature	-40°C to $+85^\circ\text{C}$		± 1.1		dBm
vs. Voltage	5 V, @ 5% (4.75 V to 5.25 V)		± 0.5		dBm
NOISE FIGURE	Frequency = 1700 MHz to 2300 MHz		5		dB
INPUT RETURN LOSS S_{11}	Frequency = 1930 MHz to 2170 MHz		-15		dB
OUTPUT RETURN LOSS S_{22}	Frequency = 1930 MHz to 2170 MHz		-15		dB
OIP3	Carrier spacing = 1 MHz, $P_{OUT} = 5\text{ dBm}$ per carrier				
	Frequency = 1960 MHz		42.5		dBm
vs. Frequency	1930 MHz to 1990 MHz		± 0.5		dBm
vs. Temperature	-40°C to $+85^\circ\text{C}$		± 1		dBm
vs. Voltage	4.75 V to 5.25 V		± 2		dBm
	Frequency = 2140 MHz		43.5		dBm
vs. Frequency	2110 MHz to 2170 MHz		± 0.15		dBm
vs. Temperature	-40°C to $+85^\circ\text{C}$		± 0.75		dBm
vs. Voltage	4.75 V to 5.25 V		± 1.8		dBm
POWER SUPPLY					
Supply Voltage		4.75	5	5.25	V
Supply Current	$P_{OUT} = 5\text{ dBm}$		320		mA
Operating Temperature		-40		+85	$^\circ\text{C}$

ADL5323

ABSOLUTE MAXIMUM RATINGS

Table 2.

Parameter	Rating
Supply Voltage, VPOS	6 V
Input Power (re: 50 Ω)	18 dBm
Equivalent Voltage	1.8 V rms
θ_{jC} (Paddle Soldered)	28.5°C/W
Maximum Junction Temperature	150°C
Operating Temperature Range	-40°C to +85°C
Storage Temperature Range	-65°C to +150°C
Soldering Temperature	260°C

Stresses above those listed under Absolute Maximum Ratings may cause permanent damage to the device. This is a stress rating only; functional operation of the device at these or any other conditions above those indicated in the operational section of this specification is not implied. Exposure to absolute maximum rating conditions for extended periods may affect device reliability.

ESD CAUTION

ESD (electrostatic discharge) sensitive device. Electrostatic charges as high as 4000V readily accumulate on the human body and test equipment and can discharge without detection. Although this product features proprietary ESD protection circuitry, permanent damage may occur on devices subjected to high energy electrostatic discharges. Therefore, proper ESD precautions are recommended to avoid performance degradation or loss of functionality.



PIN CONFIGURATION AND FUNCTION DESCRIPTIONS

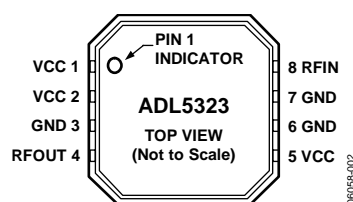

Figure 3. Pin Configuration

Table 3. Pin Function Descriptions

Pin No.	Mnemonic	Description
1, 2, 5	VCC	Positive 5 V Supply Voltage. Bypass these three pins with independent power supply decoupling networks (100 pF, 10 nF, and 10 μ F).
3, 6, 7	GND	Device Ground.
4	RFOUT	RF Output. Internally matched to 50 Ω .
8	RFIN	RF Input. Internally matched to 50 Ω .
N/A	EP	Exposed Paddle. Connect to ground plane via a low impedance path.

Table 4. S-Parameters

Frequency (GHz)	ADL5323 (1, 1)	ADL5323 (1, 2)	ADL5323 (2, 1)	ADL5323 (2, 2)
1.700	+0.223/-117.296	0.001/46.748	11.970/81.811	0.329/131.623
1.750	+0.221/-121.479	0.001/42.216	11.841/70.891	0.284/126.121
1.800	+0.213/-125.661	8.631E-4/20.038	11.719/59.628	0.237/119.974
1.850	+0.199/-125.955	7.410E-4/8.703	11.579/48.044	0.187/112.389
1.900	+0.178/-134.553	+6.610E-4/-15.411	11.430/36.098	0.138/101.953
1.950	+0.148/-139.939	+6.107E-4/-49.029	11.233/23.696	0.092/85.095
2.000	+0.109/-143.147	+7.862E-4/-93.510	10.994/10.837	0.058/47.650
2.050	+0.062/-144.310	+9.845E-4/-106.413	+10.677/-2.467	+0.064/-8.136
2.100	+0.013/-85.228	+0.001/-137.342	+10.282/-16.244	+0.103/-38.076
2.150	+0.065/-1.170	+0.002/-152.839	+9.786/-30.382	+0.151/-52.943
2.200	+0.137/-3.193	+0.002/-165.020	+9.178/-44.797	+0.201/-62.896
2.250	+0.213/-9.279	0.002/178.599	+8.460/-59.375	+0.250/-70.697
2.300	+0.288/-16.416	0.003/168.309	+7.657/-73.707	+0.298/-77.549
2.350	+0.359/-23.757	0.003/156.456	+6.820/-87.516	+0.343/-83.655
2.400	+0.423/-31.004	0.003/145.888	+6.002/-100.610	+0.386/-89.478

TYPICAL PERFORMANCE CHARACTERISTICS

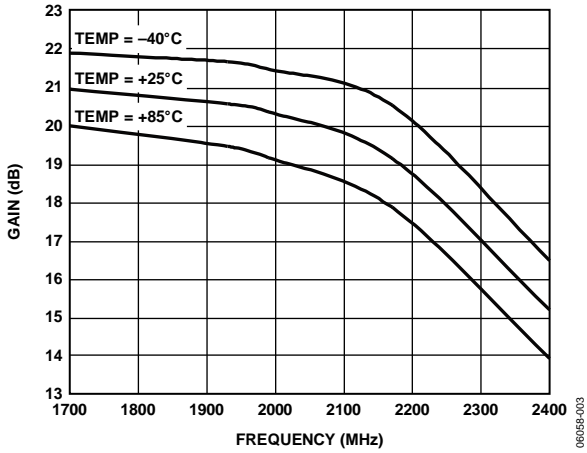

Figure 4. Gain vs. Frequency, $V_{CC} = 5\text{ V}$, $T_A = -40^\circ\text{C}$, $+25^\circ\text{C}$, and $+85^\circ\text{C}$

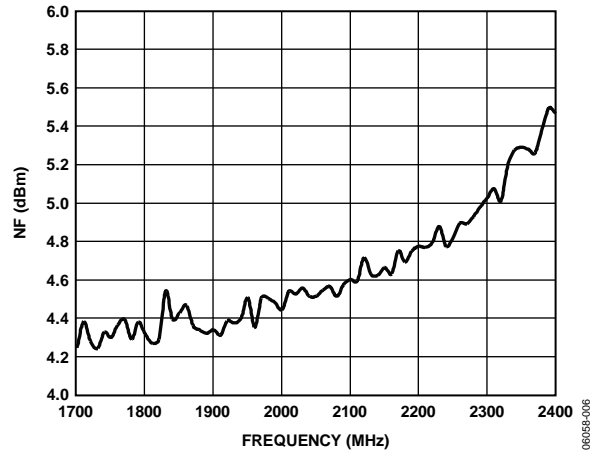

Figure 7. Noise Figure vs. Frequency, $V_{CC} = 5\text{ V}$, $T_A = 25^\circ\text{C}$

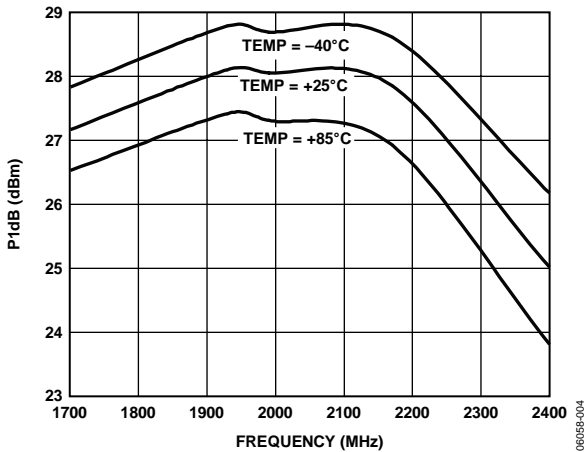

Figure 5. $P_1\text{ dB}$ vs. Frequency, $V_{CC} = 5\text{ V}$, $T_A = -40^\circ\text{C}$, $+25^\circ\text{C}$, and $+85^\circ\text{C}$

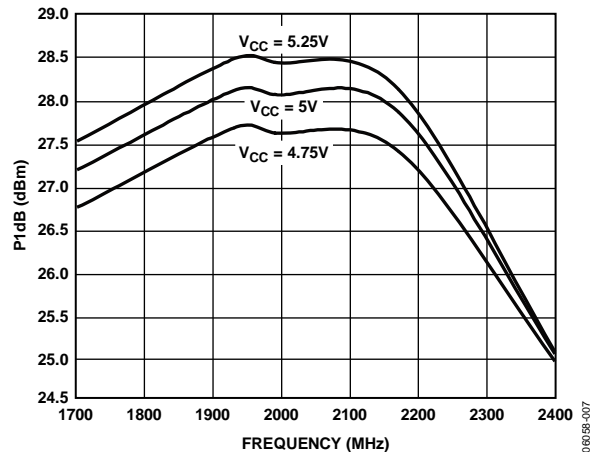

Figure 8. $P_1\text{ dB}$ vs. Frequency, $V_{CC} = 4.75\text{ V}$, 5 V , and 5.25 V , $T_A = 25^\circ\text{C}$

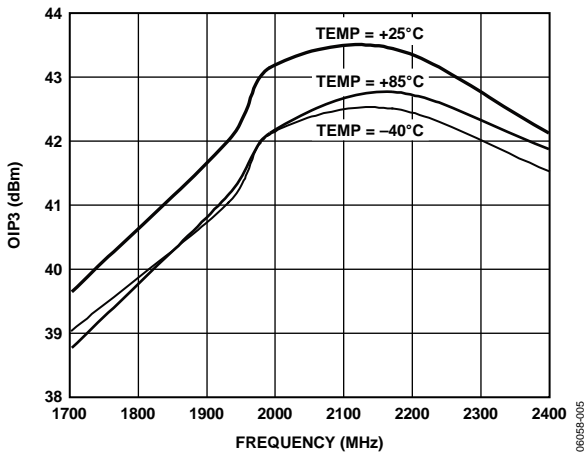

Figure 6. OIP3 vs. Frequency, $V_{CC} = 5\text{ V}$, $T_A = -40^\circ\text{C}$, $+25^\circ\text{C}$, and $+85^\circ\text{C}$

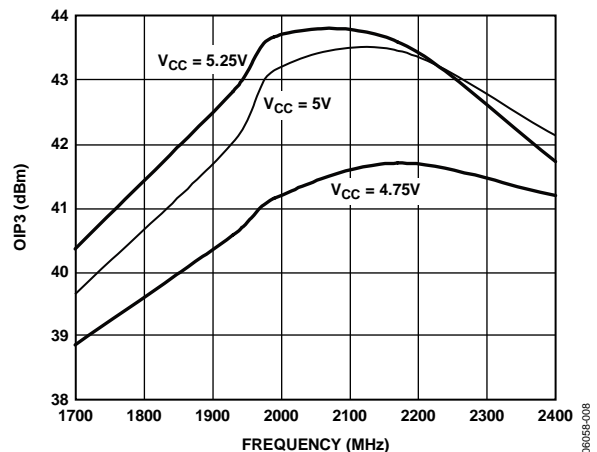

Figure 9. OIP3 vs. Frequency, $V_{CC} = 4.75\text{ V}$, 5 V , and 5.25 V , $T_A = 25^\circ\text{C}$

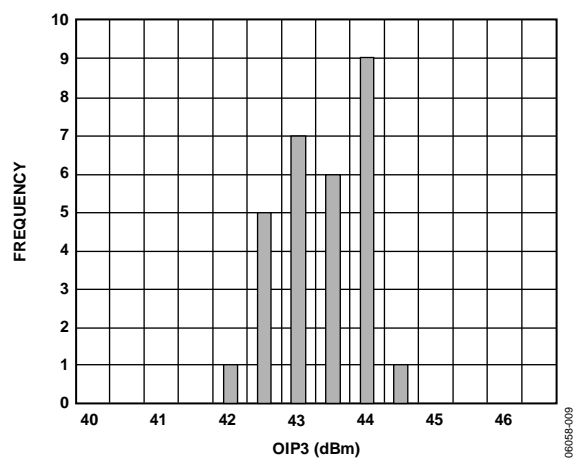

Figure 10. Distribution of OIP3 at 1990 MHz

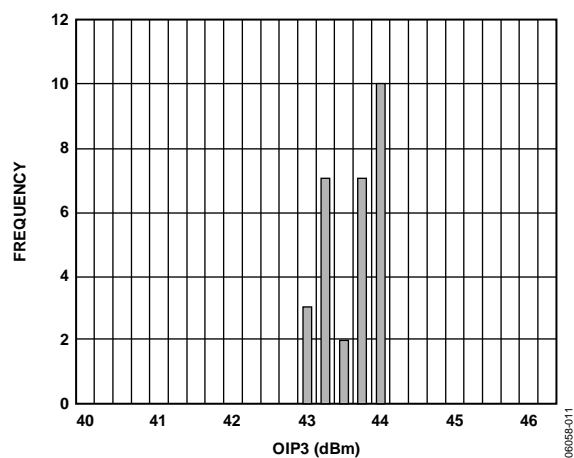

Figure 12. Distribution of OIP3 at 2170 MHz

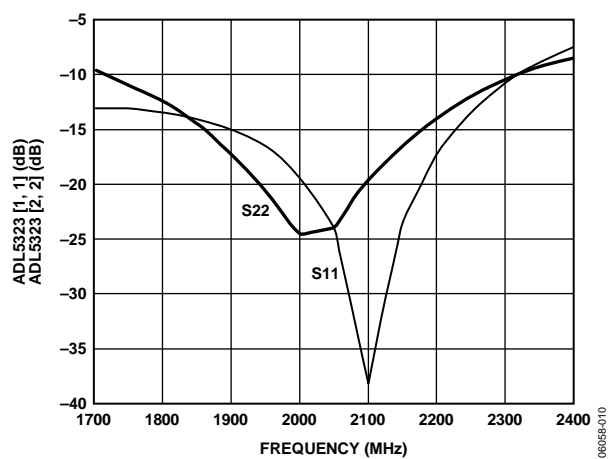

Figure 11. Input S11 and Output S22 Return Loss vs. Frequency

BASIC CONNECTIONS

Figure 16 shows the basic connections for operating the ADL5323. Each of the three power supply lines should be decoupled with 10 μF , 10 nF, and 100 pF capacitors. Pin 3, Pin 6, Pin 7, and the exposed paddle under the device should all be connected to a low impedance ground plane. If multiple ground planes are being used, these should be stitched together with vias under the device to optimize thermal conduction. See the recommended land pattern in Figure 13 for more information.

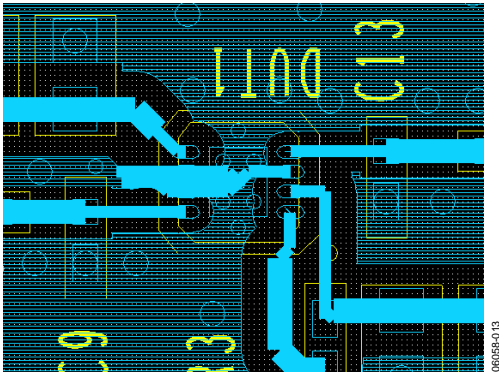

Figure 13. Recommended Land Pattern

WCDMA DRIVING APPLICATION

Figure 14 shows a plot of the spectrum of an ADL5323 driving a single carrier WCDMA signal (Test Model 1-64) at 0 dBm, centered at 2140 MHz. At 5 MHz offset, an adjacent channel power ratio of -74 was measured.

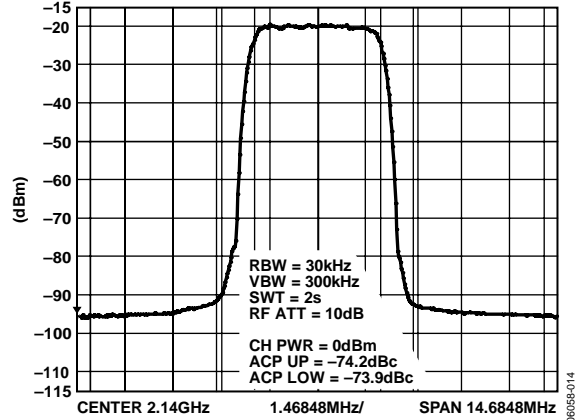

Figure 14. Spectrum of Single WCDMA Carrier Centered at 2140 MHz; Carrier Power = 0 dBm, ACPR = -74 dBc

Figure 15 shows how ACP varies with output power level. Note that in this plot, the noise floor of the spectrum analyzer was factored out.

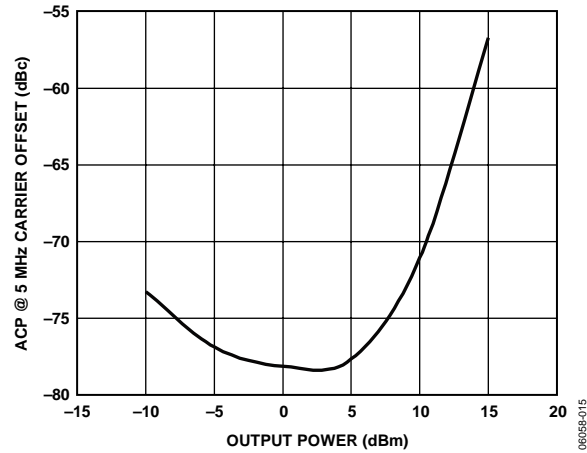

Figure 15. WCDMA ACP vs. Output Power, Single Carrier, Test Model 1-64

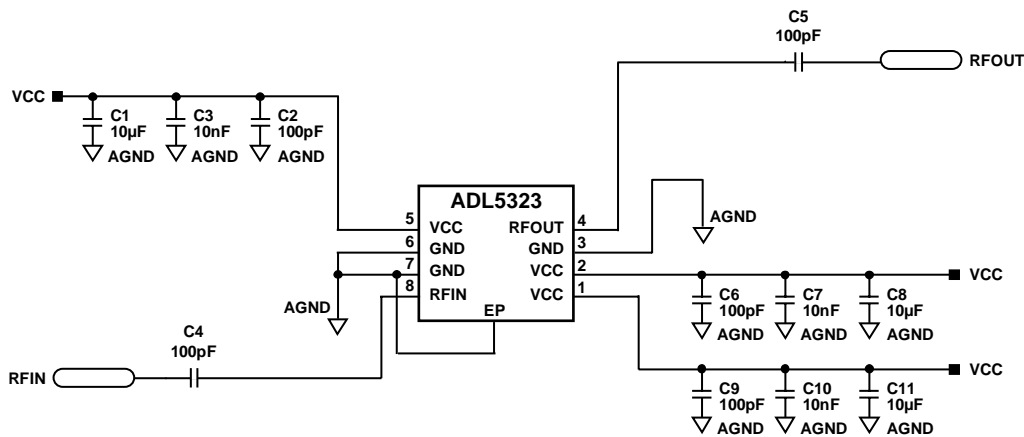

Figure 16. Basic Connections

EVALUATION BOARD

Figure 18 shows the schematic of the ADL5323 evaluation board. The board is powered by a single supply in the 4.75 V to 5.25 V range. The power supply is decoupled on each of the three power supply pins by 10 μF , 10 nF, and 100 pF capacitors. See Table 5 for the exact evaluation board component values. Note that all three VCC pins (Pin 1, Pin 2, and Pin 5) should be independently bypassed as shown in Figure 18 for proper operation.

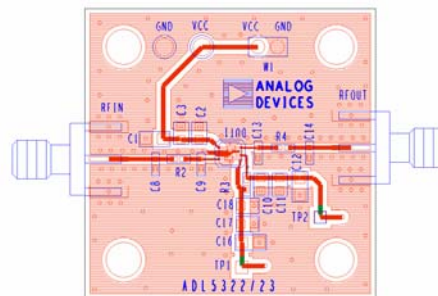

Figure 17. Evaluation Board Component Side View

Table 5. Evaluation Board Components

Component	Function	Default Value
DUT1	Driver amplifier	ADL5323
C1, C12, C16	Low frequency bypass capacitors	10 μF , 0603
C3, C11, C17	Low frequency bypass capacitors	10 nF, 0402
C2, C10, C18	High frequency bypass capacitors	100 pF, 0402
C8, C9, C13, C14, R3	Open	Open , 0402
R2, R4	AC coupling capacitors	100 pF, 0402

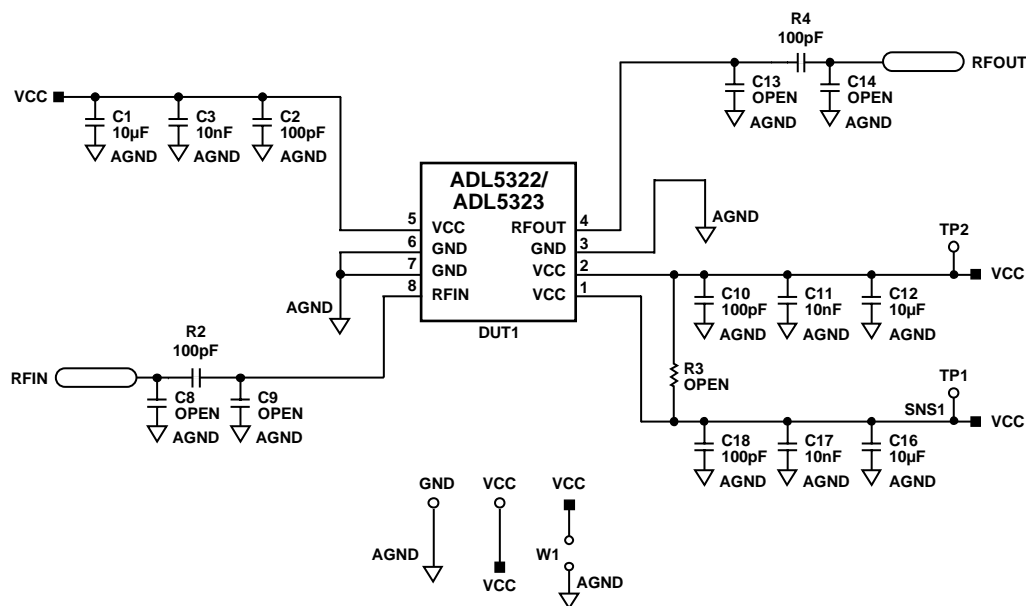

Figure 18. Evaluation Board Schematic

ADL5323

OUTLINE DIMENSIONS

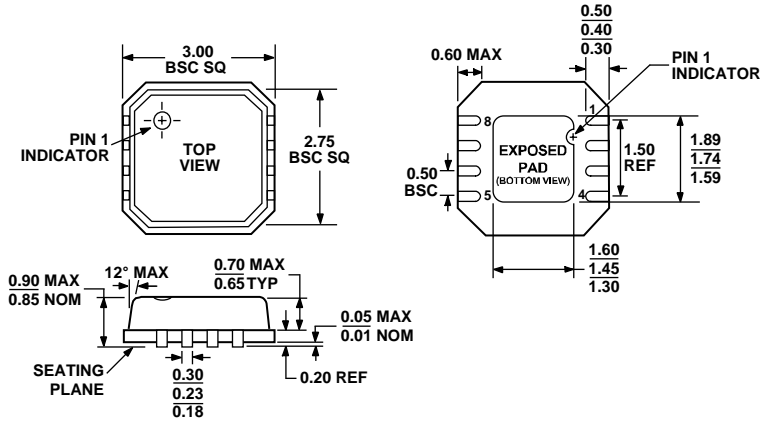

Figure 19. 8-Lead Lead Frame Chip Scale Package [LFCSP_VD]
 3 mm × 3 mm Body, Very Thin, Dual Lead
 (CP-8-2)
 Dimensions shown in millimeters

ORDERING GUIDE

Model	Temperature Range	Package Description	Package Option	Branding	Ordering Quantity
ADL5323ACPZ-R7 ¹	-40°C to +85°C	8-Lead LFCSP_VD, 7" Tape and Reel	CP-8-2	OR	1500
ADL5323ACPZ-WP ¹	-40°C to +85°C	8-Lead LFCSP_VD, Waffle Pack	CP-8-2	OR	50
ADL5323-EVAL		Evaluation Board			1

¹ Z = Pb-free part.

NOTES

ADL5323

NOTES