



5 V Slew-Rate Limited Half- and Full-Duplex RS-485/RS-422 Transceivers

ADM4850–ADM4857

FEATURES

EIA RS-485-/RS-422-compliant

Data rate options

ADM4850/ADM4854—115 kbps

ADM4851/ADM4855—500 kbps

ADM4852/ADM4856—2.5 Mbps

ADM4853/ADM4857—10 Mbps

Half- and full-duplex options

Reduced slew rates for low EMI

True fail-safe receiver inputs

5 μ A (maximum) supply current in shutdown mode

Up to 256 transceivers on one bus

Outputs high-z when disabled or powered off

–7 V to +12 V bus common-mode range

Thermal shutdown and short-circuit protection

Pin-compatible with MAX308x

Specified over the –40°C to +85°C temperature range

Available in 8-lead SOIC and LFCSP packages

APPLICATIONS

Low power RS-485 applications

EMI-sensitive systems

DTE-DCE interfaces

Industrial control

Packet switching

Local area networks

Level translators

GENERAL DESCRIPTION

The ADM4850–ADM4857 are differential line transceivers suitable for high speed half- and full-duplex data communication on multipoint bus transmission lines. They are designed for balanced data transmission and comply with EIA Standards RS-485 and RS-422. The ADM4850–ADM4853 are half-duplex transceivers, which share differential lines and have separate enable inputs for the driver and receiver. The full-duplex ADM4854–ADM4857 transceivers have dedicated differential line driver outputs and receiver inputs.

The parts have a 1/8-unit-load receiver input impedance, which allows up to 256 transceivers on one bus. Since only one driver should be enabled at any time, the output of a disabled or powered-down driver is three-stated to avoid overloading the bus.

The receiver inputs have a true fail-safe feature, which ensures a logic high output level when the inputs are open or shorted. This guarantees that the receiver outputs are in a known state before communication begins and when communication ends.

FUNCTIONAL BLOCK DIAGRAM

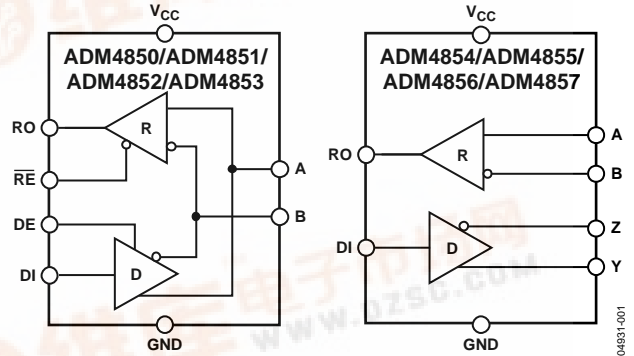

Figure 1.

The driver outputs are slew-rate limited to reduce EMI and data errors caused by reflections from improperly terminated buses. Excessive power dissipation caused by bus contention or by output shorting is prevented with a thermal shutdown circuit.

The parts are fully specified over the commercial and industrial temperature ranges, and are available in 8-lead SOIC and LFCSP packages.

Table 1. Selection Table

Part No	Half-/Full-Duplex	Data Rate
ADM4850	Half	115 kbps
ADM4851	Half	500 kbps
ADM4852	Half	2.5 Mbps
ADM4853	Half	10 Mbps
ADM4854	Full	115 kbp
ADM4855	Full	500 kbps
ADM4856	Full	2.5 Mbps
ADM4857	Full	10 Mbps

ADM4850–ADM4857

TABLE OF CONTENTS

Specifications.....	3	Circuit Description.....	12
ADM4850/ADM4854 Timing Specifications.....	4	Slew-Rate Control	12
ADM4851/ADM4855 Timing Specifications.....	4	Receiver Input Filtering.....	12
ADM4852/ADM4856 Timing Specifications.....	5	Half-/Full-Duplex Operation	12
ADM4853/ADM4857 Timing Specifications.....	5	High Receiver Input Impedance	13
Absolute Maximum Ratings.....	6	Three-State Bus Connection.....	13
ESD Caution.....	6	Shutdown Mode	13
Pin Configurations and Function Descriptions	7	Fail-Safe Operation	13
Test Circuits.....	8	Current Limit and Thermal Shutdown	13
Switching Characteristics	9	Outline Dimensions	14
Typical Performance Characteristics	10	Ordering Guide	15

REVISION HISTORY

10/04—Revision 0: Initial Version

SPECIFICATIONS

V = 5 V ± 5%, T_A = T_{MIN} to T_{MAX}, unless otherwise noted.

Table 2.

Parameter	Min	Typ	Max	Unit	Test Conditions/Comments
DRIVER					
Differential Output Voltage, V _{OD}			V _{CC}	V	R = ∞, Figure 4 ¹
	2.0		5	V	R = 50 Ω (RS-422), Figure 4
	1.5		5	V	R = 27 Ω (RS-485), Figure 4
	1.5		5	V	V _{TST} = -7 V to 12 V, Figure 5
Δ V _{OD} for Complementary Output States			0.2	V	R = 27 Ω or 50 Ω, Figure 4
Common-Mode Output Voltage, V _O			3	V	R = 27 Ω or 50 Ω, Figure 4
Δ V _O for Complementary Output States			0.2	V	R = 27 Ω or 50 Ω, Figure 4
Output Short-Circuit Current, V _{OUT} = High	-200		+200	mA	-7 V < V _{OUT} < +12 V
Output Short-Circuit Current, V _{OUT} = Low	-200		+200	mA	-7 V < V _{OUT} < +12 V
DRIVER INPUT LOGIC					
CMOS Input Logic Threshold Low		1.4	0.8	V	
CMOS Input Logic Threshold High	2.0	1.4		V	
CMOS Logic Input Current (DI)			±1	μA	
DE Input Resistance to GND		220		kΩ	
RECEIVER					
Differential Input Threshold Voltage, V _{TH}	-200	-125	-30	mV	-7 V < V _M < +12 V
Input Hysteresis		20		mV	-7 V < V _M < +12 V
Input Resistance (A, B)	96	150		kΩ	-7 V < V _M < +12 V
Input Current (A, B)			0.125	mA	V _{IN} = +12 V
			-0.1	mA	V _{IN} = -7 V
CMOS Logic Input Current (\overline{RE})			±1	μA	
CMOS Output Voltage Low			0.4	V	I _{OUT} = +4 mA
CMOS Output Voltage High	4.0			V	I _{OUT} = -4 mA
Output Short Circuit Current	7		85	mA	V _{OUT} = GND or V _{CC}
Three-State Output Leakage Current			±2	μA	0.4 V ≤ V _{OUT} ≤ 2.4 V
POWER SUPPLY CURRENT					
I (115 kbps Options)			5	μA	DE = 0 V, \overline{RE} = V _{CC} (shutdown)
		36	60	μA	DE = 0 V, \overline{RE} = 0 V
		100	160	μA	DE = V _{CC}
I (500 kbps Options)			5	μA	DE = 0 V, \overline{RE} = V _{CC} (shutdown)
		80	120	μA	DE = 0 V, \overline{RE} = 0 V
		120	200	μA	DE = V _{CC}
I (2.5 Mbps Options)			5	μA	DE = 0 V, \overline{RE} = V _{CC} (shutdown)
		250	400	μA	DE = 0 V, \overline{RE} = 0 V
		320	500	μA	DE = V _{CC}
I (10 Mbps Options)			5	μA	DE = 0 V, \overline{RE} = V _{CC} (shutdown)
		250	400	μA	DE = 0 V, \overline{RE} = 0 V
		320	500	μA	DE = V _{CC}

¹ Guaranteed by design.

ADM4850–ADM4857

ADM4850/ADM4854 TIMING SPECIFICATIONS

V = 5 V ± 5%, T_A = T_{MIN} to T_{MAX}, unless otherwise noted.

Table 3.

Parameter	Min	Typ	Max	Unit	Test Conditions/Comments
DRIVER					
Maximum Data Rate	115			kbps	
Propagation Delay t _{PLH} , t _{PHL}	600		2500	ns	R _{LDIFF} = 54 Ω, C _{L1} = C _{L2} = 100 pF, Figure 6
Skew t _{SKEW}			70	ns	R _{LDIFF} = 54 Ω, C _{L1} = C _{L2} = 100 pF, Figure 6
Rise/Fall Time t _R , t _F	600		2400	ns	R _{LDIFF} = 54 Ω, C _{L1} = C _{L2} = 100 pF, Figure 6
Enable Time			2000	ns	R _L = 500 Ω, C _L = 100 pF, Figure 7, ADM4850
Disable Time			2000	ns	R _L = 500 Ω, C _L = 15 pF, Figure 7, ADM4850
Enable Time from Shutdown		4000		ns	R _L = 500 Ω, C _L = 100 pF, Figure 7, ADM4850
RECEIVER					
Propagation Delay t _{PLH} , t _{PHL}	400		1000	ns	C _L = 15 pF, Figure 8
Differential Skew t _{SKEW}			255	ns	C _L = 15 pF, Figure 8
Enable Time		5	50	ns	R _L = 1 kΩ, C _L = 15 pF, Figure 9, ADM4850
Disable Time		20	50	ns	R _L = 1 kΩ, C _L = 15 pF, Figure 9, ADM4850
Enable Time from Shutdown		4000		ns	R _L = 1 kΩ, C _L = 15 pF, Figure 9, ADM4850
Time to Shut Down	50	330	3000	ns	ADM4850 ¹

¹ The half-duplex device is put into shutdown mode by driving \overline{RE} high and DE low. If these inputs are in this state for less than 50 ns, the device is guaranteed not to enter shutdown mode. If the enable inputs are in this state for at least 3000 ns, the device is guaranteed to enter shutdown mode.

ADM4851/ADM4855 TIMING SPECIFICATIONS

V = 5 V ± 5%, T_A = T_{MIN} to T_{MAX}, unless otherwise noted.

Table 4.

Parameter	Min	Typ	Max	Unit	Test Conditions/Comments
DRIVER					
Maximum Data Rate	500			kbps	
Propagation Delay t _{PLH} , t _{PHL}	250		600	ns	R _{LDIFF} = 54 Ω, C _{L1} = C _{L2} = 100 pF, Figure 6
Skew t _{SKEW}			40	ns	R _{LDIFF} = 54 Ω, C _{L1} = C _{L2} = 100 pF, Figure 6
Rise/Fall Time t _R , t _F	200		600	ns	R _{LDIFF} = 54 Ω, C _{L1} = C _{L2} = 100 pF, Figure 6
Enable Time			1000	ns	R _L = 500 Ω, C _L = 100 pF, Figure 7, ADM4851
Disable Time			1000	ns	R _L = 500 Ω, C _L = 15 pF, Figure 7, ADM4851
Enable Time from Shutdown		4000		ns	R _L = 500 Ω, C _L = 100 pF, Figure 7, ADM4851
RECEIVER					
Propagation Delay t _{PLH} , t _{PHL}	400		1000	ns	C _L = 15 pF, Figure 8
Differential Skew t _{SKEW}			250	ns	C _L = 15 pF, Figure 8
Enable Time		5	50	ns	R _L = 1 kΩ, C _L = 15 pF, Figure 9, ADM4851
Disable Time		20	50	ns	R _L = 1 kΩ, C _L = 15 pF, Figure 9, ADM4851
Enable Time from Shutdown		4000		ns	R _L = 1 kΩ, C _L = 15 pF, Figure 9, ADM4851
Time to Shut Down	50	330	3000	ns	ADM4851 ¹

¹ The half-duplex device is put into shutdown mode by driving \overline{RE} high and DE low. If these inputs are in this state for less than 50 ns, the device is guaranteed not to enter shutdown mode. If the enable inputs are in this state for at least 3000 ns, the device is guaranteed to enter shutdown mode.

ADM4852/ADM4856 TIMING SPECIFICATIONS

V = 5 V ± 5%, T_A = T_{MIN} to T_{MAX}, unless otherwise noted.

Table 5.

Parameter	Min	Typ	Max	Unit	Test Conditions/Comments
DRIVER					
Maximum Data Rate	2.5			Mbps	
Propagation Delay t _{PLH} , t _{PHL}	50		180	ns	R _{LDIFF} = 54 Ω, C _{L1} = C _{L2} = 100 pF, Figure 6
Skew t _{SKEW}			50	ns	R _{LDIFF} = 54 Ω, C _{L1} = C _{L2} = 100 pF, Figure 6
Rise/Fall Time t _R , t _F			140	ns	R _{LDIFF} = 54 Ω, C _{L1} = C _{L2} = 100 pF, Figure 6
Enable Time			180	ns	R _L = 500 Ω, C _L = 100 pF, Figure 7, ADM4852
Disable Time			180	ns	R _L = 500 Ω, C _L = 15 pF, Figure 7, ADM4852
Enable Time from Shutdown		4000		ns	R _L = 500 Ω, C _L = 100 pF, Figure 7, ADM4852
RECEIVER					
Propagation Delay t _{PLH} , t _{PHL}	55		190	ns	C _L = 15 pF, Figure 8
Differential Skew t _{SKEW}			50	ns	C _L = 15 pF, Figure 8
Enable Time		5	50	ns	R _L = 1 kΩ, C _L = 15 pF, Figure 9, ADM4852
Disable Time		20	50	ns	R _L = 1 kΩ, C _L = 15 pF, Figure 9, ADM4852
Enable Time from Shutdown		4000		ns	R _L = 1 kΩ, C _L = 15 pF, Figure 9, ADM4852
Time to Shut Down	50	330	3000	ns	ADM4852 ¹

¹ The half-duplex device is put into shutdown mode by driving \overline{RE} high and DE low. If these inputs are in this state for less than 50 ns, the device is guaranteed not to enter shutdown mode. If the enable inputs are in this state for at least 3000 ns, the device is guaranteed to enter shutdown mode.

ADM4853/ADM4857 TIMING SPECIFICATIONS

V = 5 V ± 5%, T_A = T_{MIN} to T_{MAX}, unless otherwise noted.

Table 6.

Parameter	Min	Typ	Max	Unit	Test Conditions/Comments
DRIVER					
Maximum Data Rate	10			Mbps	
Propagation Delay t _{PLH} , t _{PHL}	0		30	ns	R _{LDIFF} = 54 Ω, C _{L1} = C _{L2} = 100 pF, Figure 6
Skew t _{SKEW}			10	ns	R _{LDIFF} = 54 Ω, C _{L1} = C _{L2} = 100 pF, Figure 6
Rise/Fall Time t _R , t _F			30	ns	R _{LDIFF} = 54 Ω, C _{L1} = C _{L2} = 100 pF, Figure 6
Enable Time			35	ns	R _L = 500 Ω, C _L = 100 pF, Figure 7, ADM4853
Disable Time			35	ns	R _L = 500 Ω, C _L = 15 pF, Figure 7, ADM4853
Enable Time from Shutdown		4000		ns	R _L = 500 Ω, C _L = 100 pF, Figure 7, ADM4853
RECEIVER					
Propagation Delay t _{PLH} , t _{PHL}	55		190	ns	C _L = 15 pF, Figure 8
Differential Skew t _{SKEW}			30	ns	C _L = 15 pF, Figure 8
Enable Time		5	50	ns	R _L = 1 kΩ, C _L = 15 pF, Figure 9, ADM4853
Disable Time		20	50	ns	R _L = 1 kΩ, C _L = 15 pF, Figure 9, ADM4853
Enable Time from Shutdown		4000		ns	R _L = 1 kΩ, C _L = 15 pF, Figure 9, ADM4853
Time to Shut Down	50	330	3000	ns	ADM4853 ¹

¹ The half-duplex device is put into shutdown mode by driving \overline{RE} high and DE low. If these inputs are in this state for less than 50 ns, the device is guaranteed not to enter shutdown mode. If the enable inputs are in this state for at least 3000 ns, the device is guaranteed to enter shutdown mode.

ADM4850–ADM4857

ABSOLUTE MAXIMUM RATINGS

Table 7.

Parameter	Rating
V _{CC} to GND	6 V
Digital I/O Voltage (DE, RE, DI, RO _{UT})	−0.3 V to V _{CC} + 0.3 V
Driver Output/Receiver Input Voltage	−9 V to +14 V
Operating Temperature Range	−40°C to +85°C
Storage Temperature Range	−65°C to +125°C
θ _{JA} Thermal Impedance	
SOIC	110°C/W
LFCSP	62°C/W
Lead Temperature	
Soldering (10 s)	300°C
Vapour Phase (60 s)	215°C
Infrared (15 s)	220°C

Stresses above those listed under Absolute Maximum Ratings may cause permanent damage to the device. This is a stress rating only; functional operation of the device at these or any other conditions above those indicated in the operational section of this specification is not implied. Exposure to absolute maximum rating conditions for extended periods may affect device reliability.

ESD CAUTION

ESD (electrostatic discharge) sensitive device. Electrostatic charges as high as 4000 V readily accumulate on the human body and test equipment and can discharge without detection. Although this product features proprietary ESD protection circuitry, permanent damage may occur on devices subjected to high energy electrostatic discharges. Therefore, proper ESD precautions are recommended to avoid performance degradation or loss of functionality.



PIN CONFIGURATIONS AND FUNCTION DESCRIPTIONS

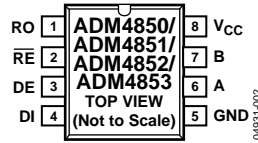

Figure 2. ADM4850–ADM4853 Pin Configuration

Table 8. ADM4850–ADM4853 Pin Descriptions

Pin No.	Mnemonic	Description
1	RO	Receiver Output. When enabled, if $(A-B) \geq -30$ mV, then RO = high. If $(A-B) \leq -200$ mV, then RO = low.
2	\overline{RE}	Receiver Output Enable. A low level enables the receiver output, RO. A high level places it in a high impedance state.
3	DE	Driver Output Enable. A high level enables the driver differential inputs A and B. A low level places it in a high impedance state.
4	DI	Driver Input. When the driver is enabled, a logic low on DI forces A low and B high, while a logic high on DI forces A high and B low.
5	GND	Ground.
6	A	Noninverting Receiver Input A/Driver Output A.
7	B	Inverting Receiver Input B/Driver Output B.
8	V _{CC}	5 V Power Supply.

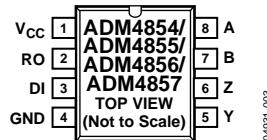

Figure 3. ADM4854–ADM4857 Pin Configuration

Table 9. ADM4854–ADM4857 Pin Descriptions

Pin No.	Mnemonic	Description
1	V _{CC}	5 V Power Supply.
2	RO	Receiver Output. When enabled, if $(A-B) \geq -30$ mV, then RO = high. If $(A-B) \leq -200$ mV, then RO = low.
3	DI	Driver Input. When the driver is enabled, a logic low on DI forces Y low and Z high, while a logic high on DI forces Y high and Z low.
4	GND	Ground.
5	Y	Driver Noninverting Output.
6	Z	Driver Inverting Output.
7	B	Receiver Inverting Input.
8	A	Receiver Noninverting Input.

TEST CIRCUITS

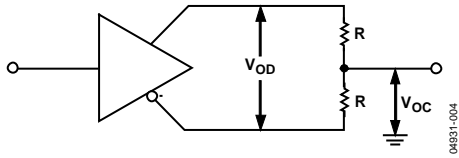

Figure 4. Driver Voltage Measurement

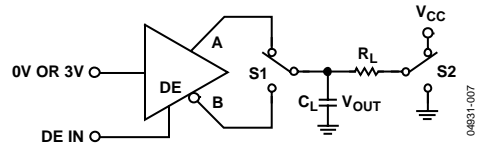

Figure 7. Driver Enable/Disable

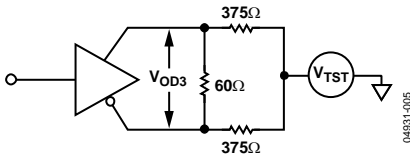

Figure 5. Driver Voltage Measurement over Common-Mode Voltage Range

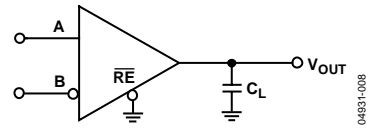

Figure 8. Receiver Propagation Delay

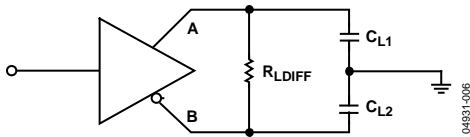

Figure 6. Driver Propagation Delay

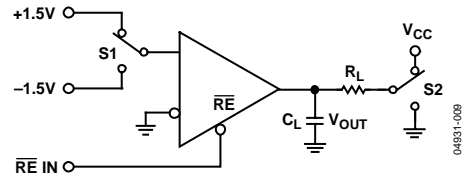

Figure 9. Receiver Enable/Disable

SWITCHING CHARACTERISTICS

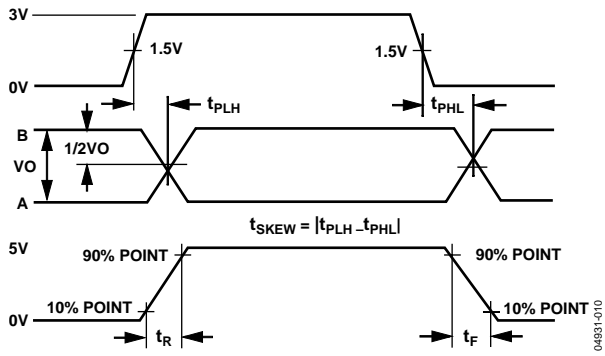

Figure 10. Driver Propagation Delay, Rise/Fall Timing

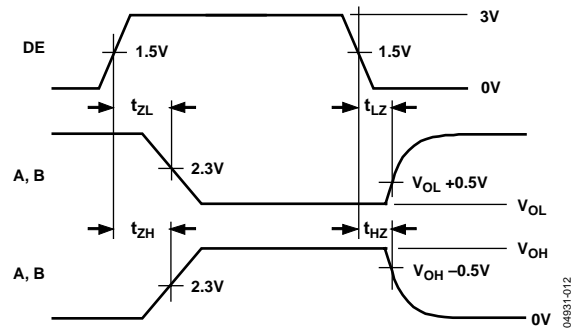

Figure 12. Driver Enable/Disable Timing

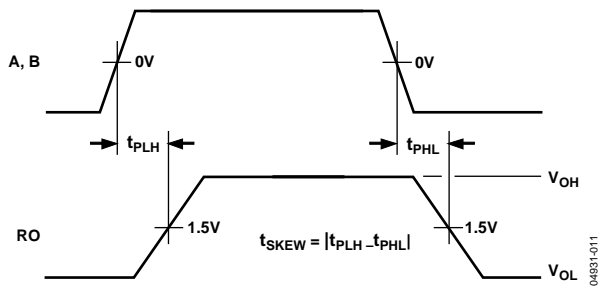

Figure 11. Receiver Propagation Delay

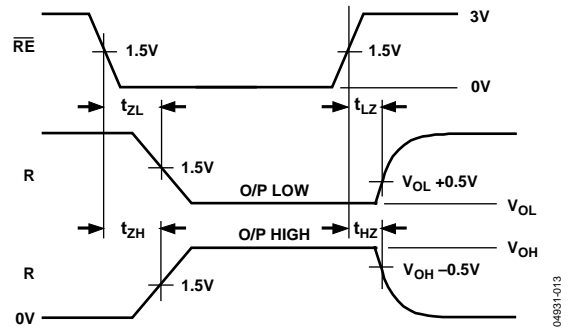

Figure 13. Receiver Enable/Disable Timing

TYPICAL PERFORMANCE CHARACTERISTICS

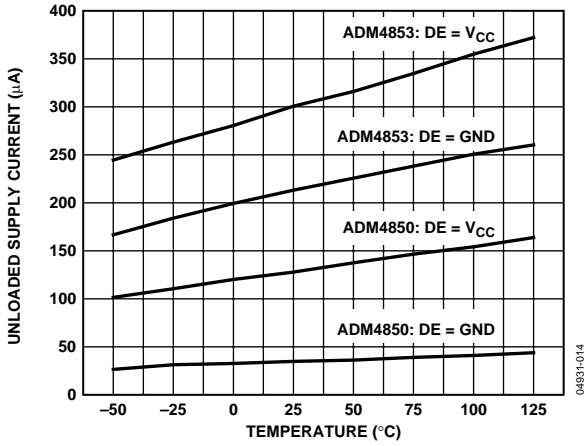

Figure 14. Unloaded Supply Current vs. Temperature

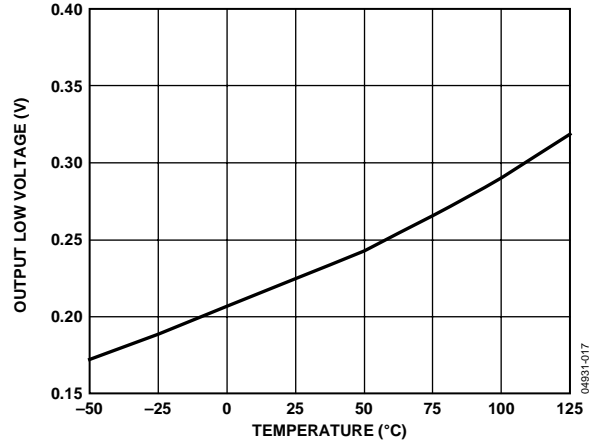

Figure 17. Receiver Output Low Voltage vs. Temperature

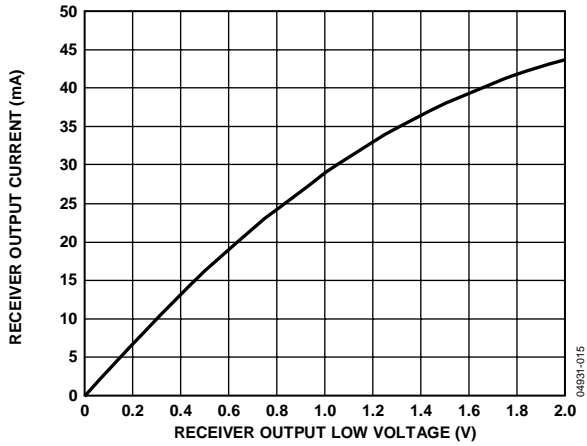

Figure 15. Output Current vs. Receiver Output Low Voltage

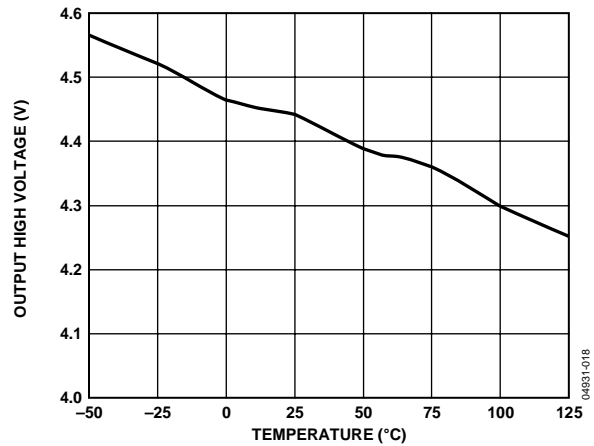

Figure 18. Receiver Output High Voltage vs. Temperature

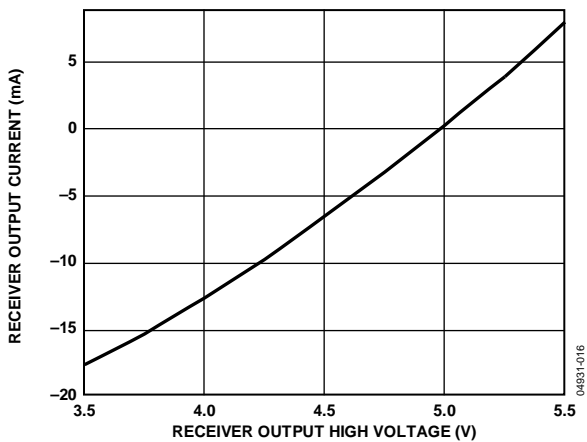

Figure 16. Output Current vs. Receiver Output High Voltage

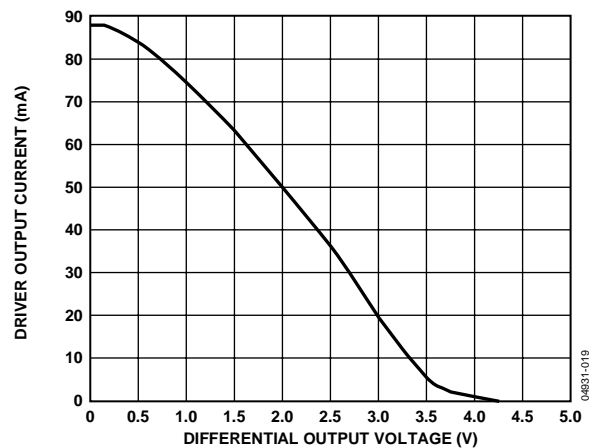

Figure 19. Driver Output Current vs. Differential Output Voltage

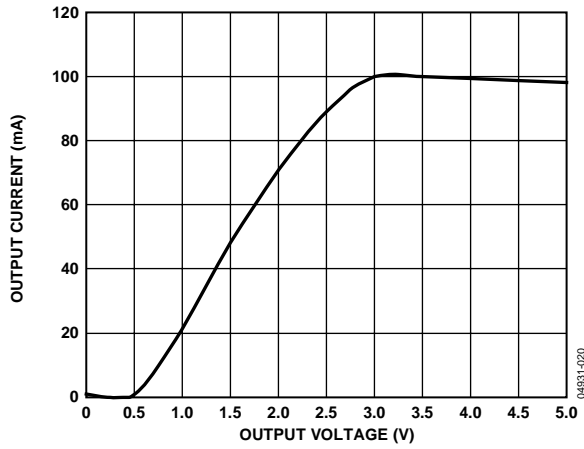

Figure 20. Output Current vs. Driver Low Voltage

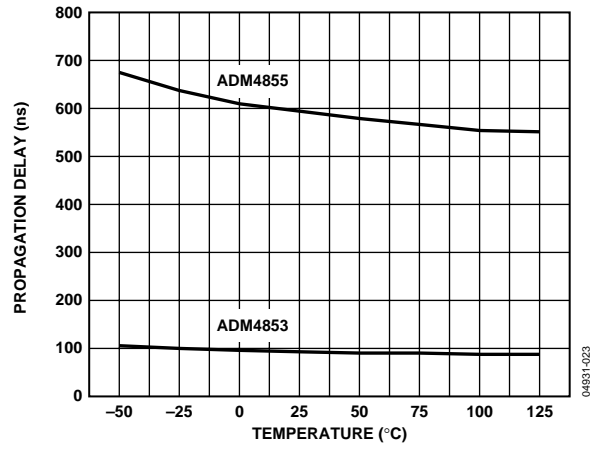

Figure 23. Receiver Propagation Delay vs. Temperature

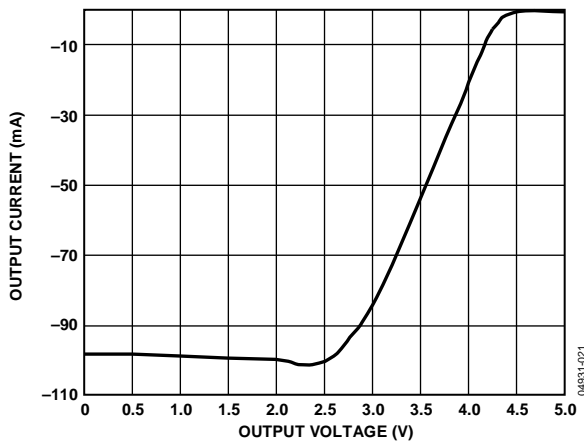

Figure 21. Output Current vs. Driver Output High Voltage

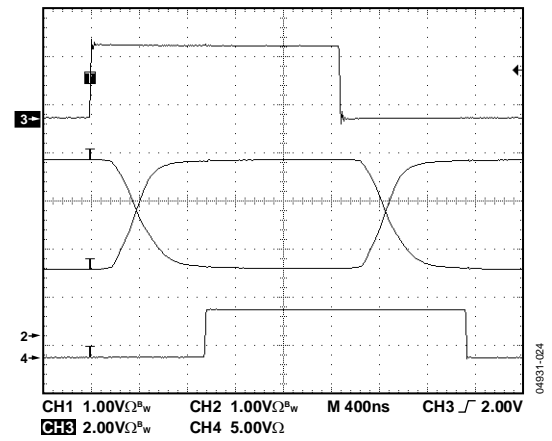

Figure 24. Driver/Receiver Propagation Delay (ADM4855, 500 kbps)

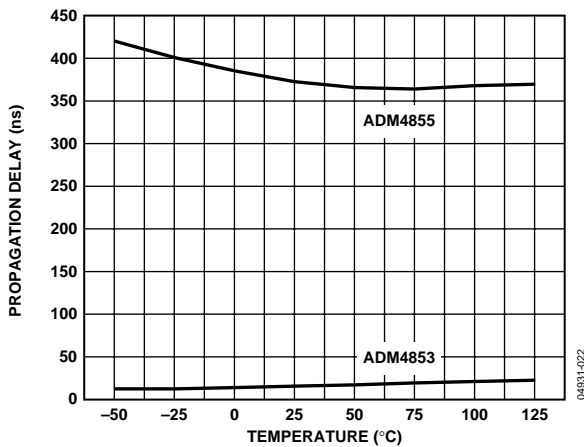

Figure 22. Driver Propagation Delay vs. Temperature

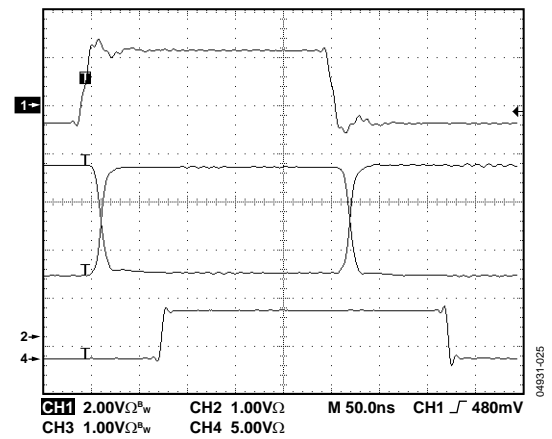

Figure 25. Driver/Receiver Propagation Delay (ADM4855, 4 Mbps)

ADM4850–ADM4857

CIRCUIT DESCRIPTION

The ADM4850–ADM4857 are high speed RS-485/RS-422 transceivers offering enhanced performance over industry-standard devices. All devices in the family contain one driver and one receiver, but offer a choice of performance options. The devices feature true fail-safe operation, which means that a logic high receiver output is guaranteed when the receiver inputs are open-circuit or short-circuit, or when they are connected to a terminated transmission line with all drivers disabled (see the Fail-Safe Operation section).

SLEW-RATE CONTROL

The ADM4850/ADM4854 feature a controlled slew-rate driver that minimizes electromagnetic interference (EMI) and reduces reflections caused by incorrectly terminated cables, allowing error-free data transmission rates up to 115 kbps. The ADM4851/ADM4855 offer a higher limit on driver output slew rate, allowing data transmission rates up to 500 kbps. The driver slew rates of the ADM4852/ADM4856 and the ADM4853/ADM4857 are not limited, offering data transmission rates up to 2.5 Mbps and 10 Mbps, respectively.

RECEIVER INPUT FILTERING

The receivers of all the devices incorporate input hysteresis. In addition, the receivers of the 115 kbps ADM4850/ADM485 and the 500 kbps ADM4851/ADM4855 incorporate input filtering. This enhances noise immunity with differential signals that have very slow rise and fall times. However, it causes the propagation delay to increase by 20%.

HALF-/FULL-DUPLEX OPERATION

Half-duplex operation implies that the transceiver can transmit and receive, but it can only do one of these at any given time. However, with full-duplex operation, the transceiver can transmit and receive simultaneously. The ADM4850–ADM4853 are half-duplex devices in which the driver and receiver share differential bus terminals. The ADM4854–ADM4857 are full-duplex devices, which have dedicated driver output and receiver input pins. Figure 26 and Figure 27 show typical half- and full-duplex topologies.

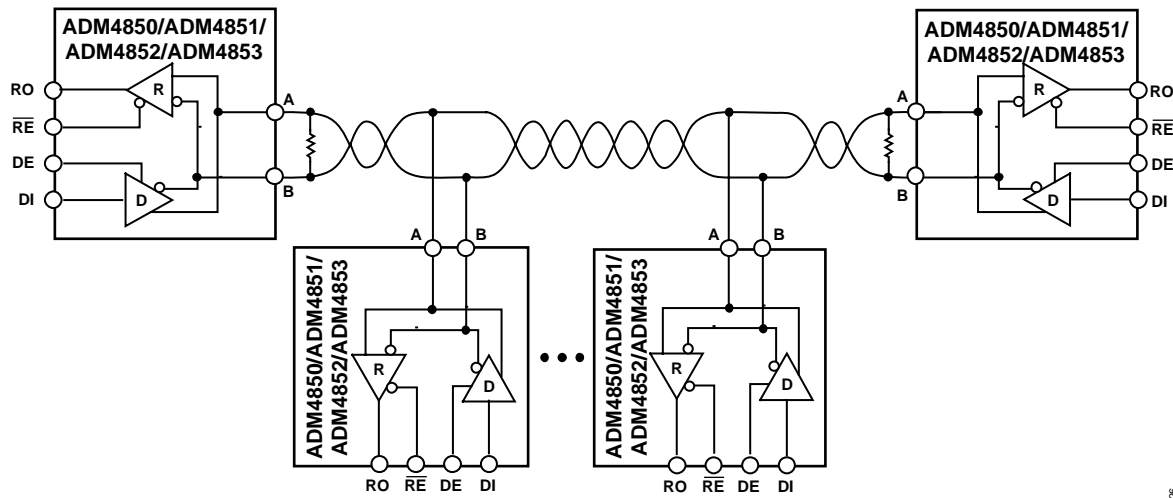

MAXIMUM NUMBER OF TRANSCEIVERS ON BUS: 256

Figure 26. Typical Half-Duplex RS-485 Network Topology

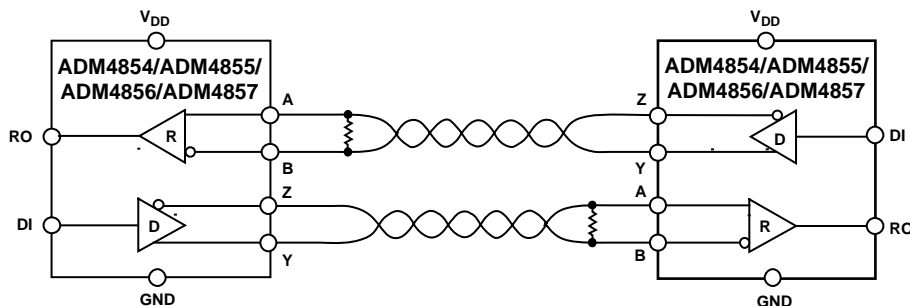

Figure 27. Typical Full-Duplex Point-to-Point RS-485 Network Topology

04831-026

04831-027

HIGH RECEIVER INPUT IMPEDANCE

The input impedance of the ADM485x receivers is 96 k Ω , which is 8 times higher than the standard RS-485 unit load of 12 k Ω . This 96 k Ω impedance, enables a standard driver to drive 32 unit loads or be connected to 256 ADM485x receivers. An RS-485 bus, driven by a single standard driver, can be connected to a combination of ADM485x and standard unit load receivers, up to an equivalent of 32 standard unit loads.

THREE-STATE BUS CONNECTION

The half-duplex parts have a driver enable (DE) pin that enables the driver outputs when taken high, or puts the driver outputs into a high impedance state when taken low. Similarly, the half-duplex devices have an active-low receiver enable ($\overline{\text{RE}}$) pin. Taking this pin low enables the receiver, while taking it high puts the receiver outputs into a high impedance state. This allows several driver outputs to be connected to an RS-485 bus. Note that only one driver should be enabled at a time, while many receivers can be enabled.

SHUTDOWN MODE

The ADM4850–ADM4853 have a low power shutdown mode, which is enabled by taking $\overline{\text{RE}}$ high and DE low. If shutdown mode is not used, the fact that DE is active high and $\overline{\text{RE}}$ is active low offers a convenient way of switching the device between transmit and receive by tying DE and $\overline{\text{RE}}$ together.

The devices are guaranteed not to enter shutdown mode if DE and $\overline{\text{RE}}$ are driven in this way. If DE is low and $\overline{\text{RE}}$ is high for less than 50 ns, the device does not enter shutdown mode. If DE is low and $\overline{\text{RE}}$ is high for less than 3000 ns, the device is guaranteed to enter shutdown mode.

FAIL-SAFE OPERATION

The ADM4850–ADM4857 offer true fail-safe operation while remaining fully compliant with the ± 200 mV EIA/TIA-485 standard. A logic-high receiver output is generated when the receiver inputs are shorted together or open-circuit, or when they are connected to a terminated transmission line with all drivers disabled. This is done by setting the receiver threshold between -30 mV and -200 mV. If the differential receiver input voltage (A-B) is greater than or equal to -30 mV, RO is logic high. If A-B is less than or equal to -200 mV, RO is logic low. In the case of a terminated bus with all transmitters disabled, the receiver's differential input voltage is pulled to 0 V by the ADM485x's internal circuitry, which results in a logic high with 30 mV minimum noise margin.

CURRENT LIMIT AND THERMAL SHUTDOWN

The ADM485x incorporates two protection mechanisms to guard the drivers against short circuits, bus contention, or other fault conditions. The first is a current-limiting output stage, which protects the driver against short circuits over the entire common-mode voltage range by limiting the output current to approximately 70 mA. Under extreme fault conditions where the current limit is not effective, a thermal shutdown circuit puts the driver outputs into a high impedance state if the die temperature exceeds 150°C, and does not turn them back on until the temperature falls to 130°C.

ADM4850-ADM4857

OUTLINE DIMENSIONS

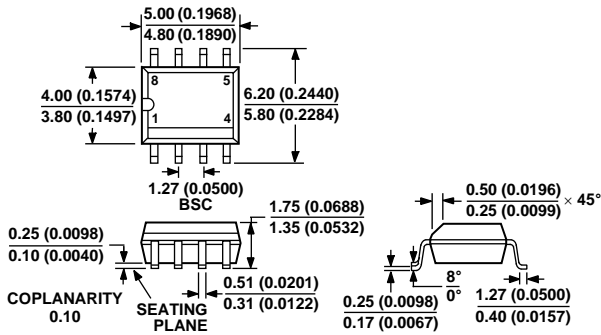

COMPLIANT TO JEDEC STANDARDS MS-012AA
 CONTROLLING DIMENSIONS ARE IN MILLIMETERS; INCH DIMENSIONS
 (IN PARENTHESES) ARE ROUNDED-OFF MILLIMETER EQUIVALENTS FOR
 REFERENCE ONLY AND ARE NOT APPROPRIATE FOR USE IN DESIGN

Figure 28. 8-Lead Standard Small Outline Package [SOIC]
 Narrow Body (R-8)
 Dimensions shown in millimeters and (inches)

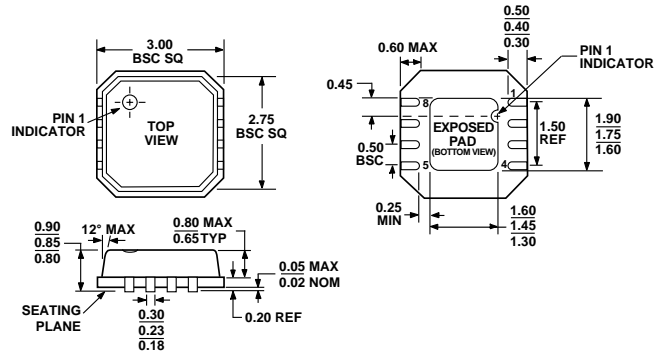

Figure 29. 8-Lead Lead Frame Chip Scale Package [LFCS]
 (CP-8-2)
 Dimensions shown in millimeters

ORDERING GUIDE

Model	Temperature Range	Package Description	Package Type	Branding
ADM4850ACP-REEL	–40°C to +85°C	8-Lead Lead Frame Chip Scale Package	CP-8-2	MOR
ADM4850ACP-REEL7	–40°C to +85°C	8-Lead Lead Frame Chip Scale Package	CP-8-2	MOR
ADM4850AR	–40°C to +85°C	8-Lead Standard Small Outline Package	R-8	
ADM4850AR-REEL	–40°C to +85°C	8-Lead Standard Small Outline Package	R-8	
ADM4850AR-REEL7	–40°C to +85°C	8-Lead Standard Small Outline Package	R-8	
ADM4851ACP-REEL	–40°C to +85°C	8-Lead Lead Frame Chip Scale Package	CP-8-2	MOS
ADM4851ACP-REEL7	–40°C to +85°C	8-Lead Lead Frame Chip Scale Package	CP-8-2	MOS
ADM4851AR	–40°C to +85°C	8-Lead Standard Small Outline Package	R-8	
ADM4851AR-REEL	–40°C to +85°C	8-Lead Standard Small Outline Package	R-8	
ADM4851AR-REEL7	–40°C to +85°C	8-Lead Standard Small Outline Package	R-8	
ADM4852ACP-REEL	–40°C to +85°C	8-Lead Lead Frame Chip Scale Package	CP-8-2	MOT
ADM4852ACP-REEL7	–40°C to +85°C	8-Lead Lead Frame Chip Scale Package	CP-8-2	MOT
ADM4852AR	–40°C to +85°C	8-Lead Standard Small Outline Package	R-8	
ADM4852AR-REEL	–40°C to +85°C	8-Lead Standard Small Outline Package	R-8	
ADM4852AR-REEL7	–40°C to +85°C	8-Lead Standard Small Outline Package	R-8	
ADM4853ACP-REEL	–40°C to +85°C	8-Lead Lead Frame Chip Scale Package	CP-8-2	M0U
ADM4853ACP-REEL7	–40°C to +85°C	8-Lead Lead Frame Chip Scale Package	CP-8-2	M0U
ADM4853AR	–40°C to +85°C	8-Lead Standard Small Outline Package	R-8	
ADM4853AR-REEL	–40°C to +85°C	8-Lead Standard Small Outline Package	R-8	
ADM4853AR-REEL7	–40°C to +85°C	8-Lead Standard Small Outline Package	R-8	
ADM4854AR	–40°C to +85°C	8-Lead Standard Small Outline Package	R-8	
ADM4855AR	–40°C to +85°C	8-Lead Standard Small Outline Package	R-8	
ADM4855AR-REEL	–40°C to +85°C	8-Lead Standard Small Outline Package	R-8	
ADM4855AR-REEL7	–40°C to +85°C	8-Lead Standard Small Outline Package	R-8	
ADM4856AR	–40°C to +85°C	8-Lead Standard Small Outline Package	R-8	
ADM4856AR-REEL	–40°C to +85°C	8-Lead Standard Small Outline Package	R-8	
ADM4856AR-REEL7	–40°C to +85°C	8-Lead Standard Small Outline Package	R-8	
ADM4857AR	–40°C to +85°C	8-Lead Standard Small Outline Package	R-8	
ADM4857AR-REEL	–40°C to +85°C	8-Lead Standard Small Outline Package	R-8	
ADM4857AR-REEL7	–40°C to +85°C	8-Lead Standard Small Outline Package	R-8	

ADM4850–ADM4857

NOTES