



SHARC® DSP Microcomputer

ADSP-21160M

SUMMARY

High-Performance 32-Bit DSP—Applications in Audio, Medical, Military, Graphics, Imaging, and Communication

Super Harvard Architecture—Four Independent Buses for Dual Data Fetch, Instruction Fetch, and Nonintrusive, Zero-Overhead I/O

Backwards-Compatible—Assembly Source Level Compatible with Code for ADSP-2106x DSPs

Single-Instruction-Multiple-Data (SIMD) Computational Architecture—Two 32-Bit IEEE Floating-Point Computation Units, Each with a Multiplier, ALU, Shifter, and Register File

Integrated Peripherals—Integrated I/O Processor, 4 M Bit On-Chip Dual-Ported SRAM, Glueless Multiprocessing Features, and Ports (Serial, Link, External Bus, and JTAG)

KEY FEATURES

80 MHz (12.5 ns) Core Instruction Rate

Single-Cycle Instruction Execution, Including SIMD Operations in Both Computational Units

480 MFLOPS Peak and 320 MFLOPS Sustained Performance (Based on FIR)

Dual Data Address Generators (DAGs) with Modulo and Bit-Reverse Addressing

Zero-Overhead Looping and Single-Cycle Loop Setup, Providing Efficient Program Sequencing

IEEE 1149.1 JTAG Standard Test Access Port and On-Chip Emulation

400-Ball 27 × 27 mm Metric PBGA Package

FUNCTIONAL BLOCK DIAGRAM

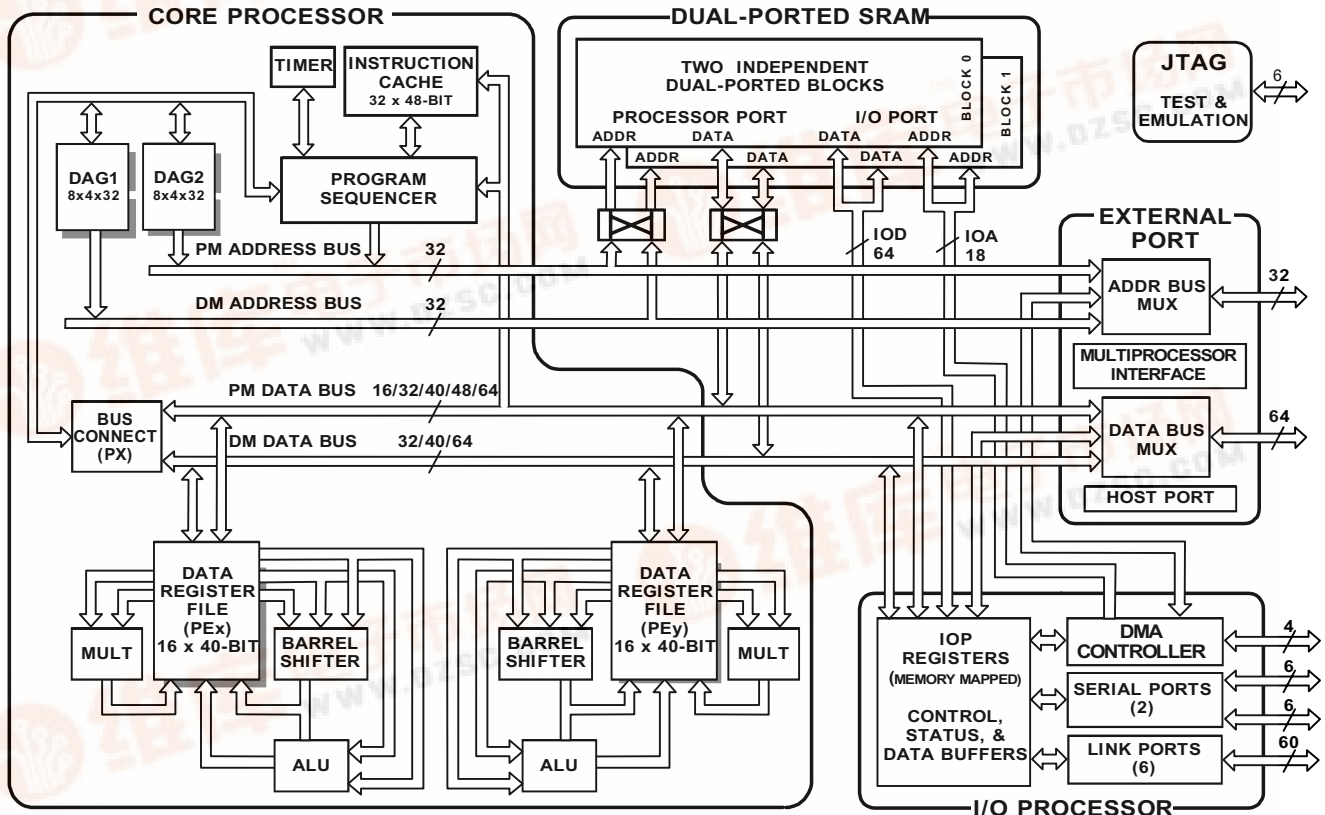

SHARC is a registered trademark of Analog Devices, Inc.

REV. 0

Information furnished by Analog Devices is believed to be accurate and reliable. However, no responsibility is assumed by Analog Devices for its use, nor for any infringements of patents or other rights of third parties which may result from its use. No license is granted by implication or otherwise.

ADSP-21160M

FEATURES (CONTINUED)

Single Instruction Multiple Data (SIMD)

Architecture Provides:

Two Computational Processing Elements

Concurrent Execution—Each Processing Element

Executes the Same Instruction, but Operates on Different Data

Code Compatibility—at Assembly Level, Uses the

Same Instruction Set as the ADSP-2106x

SHARC DSPs

Parallelism in Buses and Computational Units Allows:

Single-cycle Execution (with or without SIMD) of: A

Multiply Operation, An ALU Operation, A Dual

Memory Read or Write, and An Instruction Fetch

Transfers Between Memory and Core at up to Four

32-Bit Floating- or Fixed-Point Words per Cycle

Accelerated FFT Butterfly Computation Through a

Multiply with Add and Subtract

4M Bit On-Chip Dual-Ported SRAM for Independent

Access by Core Processor, Host, and DMA

DMA Controller supports:

14 Zero-Overhead DMA Channels for Transfers Between

ADSP-21160M Internal Memory and External

Memory, External Peripherals, Host Processor, Serial

Ports, or Link Ports

64-Bit Background DMA Transfers at Core Clock Speed,

in Parallel with Full-Speed Processor Execution

560M Bytes/s Transfer Rate Over IOP Bus

Host Processor Interface to 16- and 32-Bit

Microprocessors

4G Word Address Range for Off-Chip Memory

Memory Interface Supports Programmable Wait State

Generation and Page-Mode for Off-Chip Memory

Multiprocessing Support Provides:

Glueless Connection for Scalable DSP Multiprocessing

Architecture

Distributed On-Chip Bus Arbitration for Parallel Bus

Connect of up to Six ADSP-21160Ms plus Host

Six Link Ports for Point-To-Point Connectivity and Array

Multiprocessing

Serial Ports Provide:

Two 40M Bit/s Synchronous Serial Ports with

Companding Hardware

Independent Transmit and Receive Functions

TDM Support for T1 and E1 Interfaces

64-Bit Wide Synchronous External Port Provides:

Glueless Connection to Asynchronous and SBSRAM

External Memories

Up to 40 MHz Operation

GENERAL DESCRIPTION

The ADSP-21160M SHARC DSP is the first processor in a new family featuring Analog Devices' Super Harvard Architecture. Easing portability, the ADSP-21160M is application source code compatible with first generation ADSP-2106x SHARC DSPs in SISD (Single Instruction, Single Data) mode. To take advantage of the processor's SIMD (Single Instruction, Multiple Data) capability, some code changes are needed. Like other SHARCs, the ADSP-21160M is a 32-bit processor that is optimized for high performance DSP applications. The ADSP-21160M includes an 80 MHz core, a dual-ported on-chip SRAM, an integrated I/O processor with multiprocessing support, and multiple internal buses to eliminate I/O bottlenecks.

The ADSP-21160M introduces Single-Instruction, Multiple-Data (SIMD) processing. Using two computational units (ADSP-2106x SHARC DSPs have one), the ADSP-21160M can double performance versus the ADSP-2106x on a range of DSP algorithms.

Fabricated in a state of the art, high speed, low power CMOS process, the ADSP-21160M has a 12.5 ns instruction cycle time. With its SIMD computational hardware running at 80 MHz, the ADSP-21160M can perform 480 million math operations per second.

Table 1 shows performance benchmarks for the ADSP-21160M.

Table 1. ADSP-21160M Benchmarks

Benchmark Algorithm	Speed
1024 Point Complex FFT (Radix 4, with reversal)	115 μ s
FIR Filter (per tap)	6.25 ns
IIR Filter (per biquad)	25 ns
Matrix Multiply (pipelined) [3 \times 3] \times [3 \times 1]	56.25 ns
Matrix Multiply (pipelined) [4 \times 4] \times [4 \times 1]	100 ns
Divide (y/x)	37.5 ns
Inverse Square Root	56.25 ns
DMA Transfer Rate	560M Bytes/s

These benchmarks provide single-channel extrapolations of measured dual-channel processing performance. For more information on benchmarking and optimizing DSP code for single- and dual-channel processing, see Analog Devices' website.

The ADSP-21160M continues SHARC's industry-leading standards of integration for DSPs, combining a high-performance 32-bit DSP core with integrated, on-chip system features. These features include a 4M bit dual ported SRAM memory, host processor interface, I/O processor that supports 14 DMA channels, two serial ports, six link ports, external parallel bus, and glueless multiprocessing.

The functional block diagram on page 1 shows a block diagram of the ADSP-21160M, illustrating the following architectural features:

- Two processing elements, each made up of an ALU, Multiplier, Shifter, and Data Register File
- Data Address Generators (DAG1, DAG2)
- Program sequencer with instruction cache
- PM and DM buses capable of supporting four 32-bit data transfers between memory and the core every core processor cycle
- Interval timer
- On-Chip SRAM (4 Mbit)
- External port that supports:
 - Interfacing to off-chip memory peripherals
 - Glueless multiprocessing support for six ADSP-21160M SHARCs
 - Host port
- DMA controller
- Serial ports and link ports
- JTAG test access port

Figure 1 shows a typical single-processor system. A multiprocessing system appears in Figure 4.

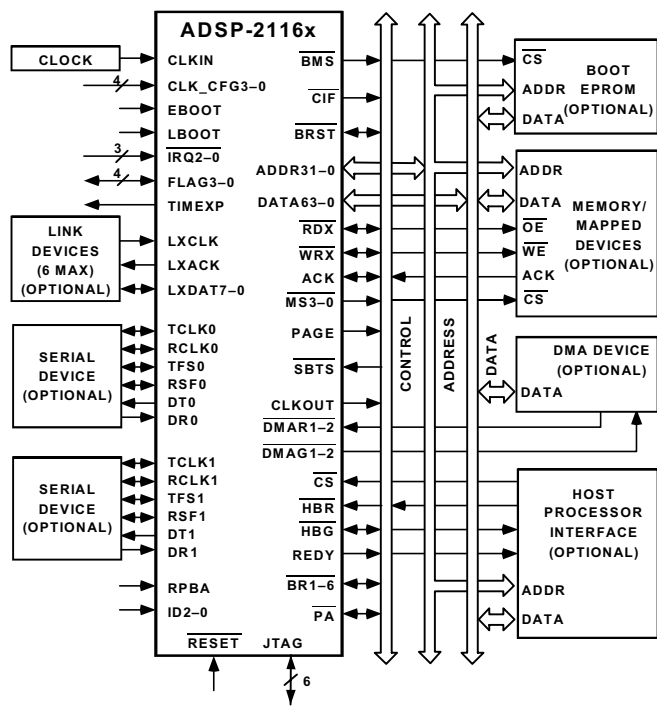

Figure 1. Single-Processor System

ADSP-21160M Family Core Architecture

The ADSP-21160M includes the following architectural features of the ADSP-2116x family core. The ADSP-21160M is code compatible at the assembly level with the ADSP-21060, ADSP-21061, and ADSP-21062.

SIMD Computational Engine

The ADSP-21160M contains two computational processing elements that operate as a Single Instruction Multiple Data (SIMD) engine. The processing elements are referred to as PEX and PEY, and each contains an ALU, multiplier, shifter, and register file. PEX is always active, and PEY may be enabled by setting the PEYEN mode bit in the MODE1 register. When this mode is enabled, the same instruction is executed in both processing elements, but each processing element operates on different data. This architecture is efficient at executing math-intensive DSP algorithms.

Entering SIMD mode also has an effect on the way data is transferred between memory and the processing elements. When in SIMD mode, twice the data bandwidth is required to sustain computational operation in the processing elements. Because of this requirement, entering SIMD mode also doubles the bandwidth between memory and the processing elements. When using the DAGs to transfer data in SIMD mode, two data values are transferred with each access of memory or the register file.

Independent, Parallel Computation Units

Within each processing element is a set of computational units. The computational units consist of an arithmetic/logic unit (ALU), multiplier, and shifter. These units perform single-cycle instructions. The three units within each processing element are arranged in parallel, maximizing computational throughput. Single multifunction instructions execute parallel ALU and multiplier operations. In SIMD mode, the parallel ALU and multiplier operations occur in both processing elements. These computation units support IEEE 32-bit single-precision floating-point, 40-bit extended precision floating-point, and 32-bit fixed-point data formats.

Data Register File

A general-purpose data register file is contained in each processing element. The register files transfer data between the computation units and the data buses, and store intermediate results. These 10-port, 32-register (16 primary, 16 secondary) register files, combined with the ADSP-2116x enhanced Harvard architecture, allow unconstrained data flow between computation units and internal memory. The registers in PEX are referred to as R0–R15 and in PEY as S0–S15.

Single-Cycle Fetch of Instruction and Four Operands

The ADSP-21160M features an enhanced Harvard architecture in which the data memory (DM) bus transfers data, and the program memory (PM) bus transfers both instructions and data (see the functional block diagram on page 1).

ADSP-21160M

With the ADSP-21160M's separate program and data memory buses and on-chip instruction cache, the processor can simultaneously fetch four operands and an instruction (from the cache), all in a single cycle.

Instruction Cache

The ADSP-21160M includes an on-chip instruction cache that enables three-bus operation for fetching an instruction and four data values. The cache is selective—only the instructions whose fetches conflict with PM bus data accesses are cached. This cache allows full-speed execution of core, providing looped operations such as digital filter multiply-accumulates and FFT butterfly processing.

Data Address Generators with Hardware Circular Buffers

The ADSP-21160M's two data address generators (DAGs) are used for indirect addressing and provide for implementing circular data buffers in hardware. Circular buffers allow efficient programming of delay lines and other data structures required in digital signal processing, and are commonly used in digital filters and Fourier transforms. The two DAGs of the ADSP-21160M contain sufficient registers to allow the creation of up to 32 circular buffers (16 primary register sets, 16 secondary). The DAGs automatically handle address pointer wraparound, reducing overhead, increasing performance, and simplifying implementation. Circular buffers can start and end at any memory location.

Flexible Instruction Set

The 48-bit instruction word accommodates a variety of parallel operations, for concise programming. For example, the ADSP-21160M can conditionally execute a multiply, an add, and subtract, in both processing elements, while branching, all in a single instruction.

ADSP-21160M Memory and I/O Interface Features

Augmenting the ADSP-2116x family core, the ADSP-21160M adds the following architectural features:

Dual-Ported On-Chip Memory

The ADSP-21160M contains four megabits of on-chip SRAM, organized as two blocks of 2 Mbits each, which can be configured for different combinations of code and data storage. Each memory block is dual-ported for single-cycle, independent accesses by the core processor and I/O processor. The dual-ported memory in combination with three separate on-chip buses allows two data transfers from the core and one from I/O processor, in a single cycle. On the ADSP-21160M, the memory can be configured as a maximum of 128K words of 32-bit data, 256K words of 16-bit data, 85K words of 48-bit instructions (or 40-bit data), or combinations of different word sizes up to four megabits. All of the memory can be accessed as 16-bit, 32-bit, 48-bit, or 64-bit words. A 16-bit floating-point storage format is supported that effectively doubles the amount of data that may be stored on-chip. Conversion

between the 32-bit floating-point and 16-bit floating-point formats is done in a single instruction. While each memory block can store combinations of code and data, accesses are most efficient when one block stores data, using the DM bus for transfers, and the other block stores instructions and data, using the PM bus for transfers. Using the DM bus and PM bus in this way, with one dedicated to each memory block, assures single-cycle execution with two data transfers. In this case, the instruction must be available in the cache.

Off-Chip Memory and Peripherals Interface

The ADSP-21160M's external port provides the processor's interface to off-chip memory and peripherals. The 4G word off-chip address space is included in the ADSP-21160M's unified address space. The separate on-chip buses—for PM addresses, PM data, DM addresses, DM data, I/O addresses, and I/O data—are multiplexed at the external port to create an external system bus with a single 32-bit address bus and a single 64-bit data bus. The lower 32 bits of the external data bus connect to even addresses and the upper 32 bits of the 64 connect to odd addresses. Every access to external memory is based on an address that fetches a 32-bit word, and with the 64-bit bus, two address locations can be accessed at once. When fetching an instruction from external memory, two 32-bit data locations are being accessed (16 bits are unused). [Figure 3](#) shows the alignment of various accesses to external memory.

The external port supports asynchronous, synchronous, and synchronous burst accesses. ZBT synchronous burst SRAM can be interfaced gluelessly. Addressing of external memory devices is facilitated by on-chip decoding of high-order address lines to generate memory bank select signals. Separate control lines are also generated for simplified addressing of page-mode DRAM. The ADSP-21160M provides programmable memory wait states and external memory acknowledge controls to allow interfacing to DRAM and peripherals with variable access, hold, and disable time requirements.

DMA Controller

The ADSP-21160M's on-chip DMA controller allows zero-overhead data transfers without processor intervention. The DMA controller operates independently and invisibly to the processor core, allowing DMA operations to occur while the core is simultaneously executing its program instructions. DMA transfers can occur between the ADSP-21160M's internal memory and external memory, external peripherals, or a host processor. DMA transfers can also occur between the ADSP-21160M's internal memory and its serial ports or link ports. External bus packing to 16-, 32-, 48-, or 64-bit words is performed during DMA transfers. Fourteen channels of DMA are available on the ADSP-21160M—six via the link ports, four via the serial ports, and four via the processor's external port (for either

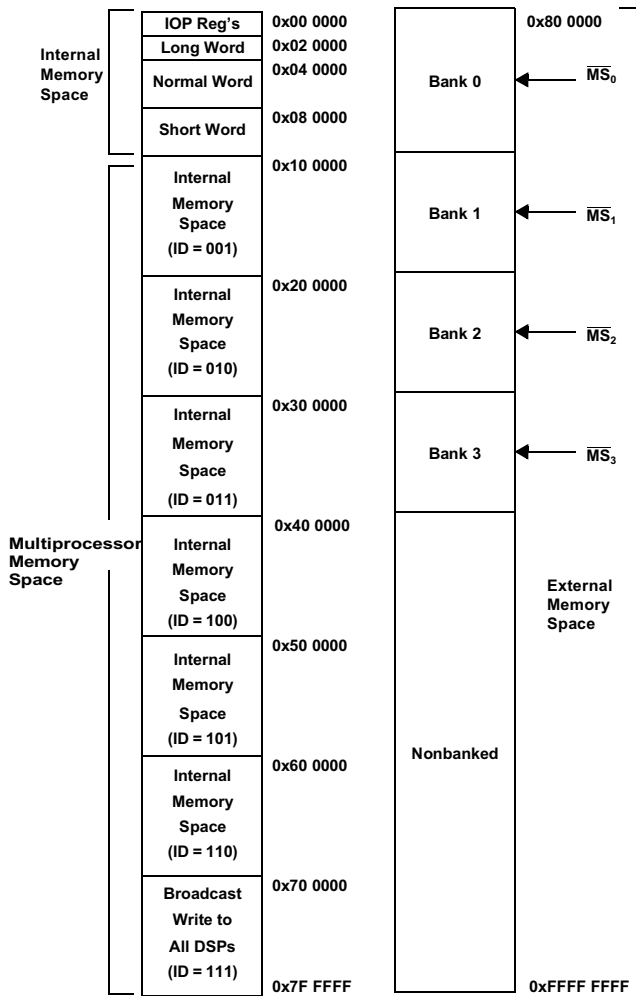

Figure 2. ADSP-21160M Memory Map

host processor, other ADSP-21160Ms, memory or I/O transfers). Programs can be downloaded to the ADSP-21160M using DMA transfers. Asynchronous off-chip peripherals can control two DMA channels using DMA Request/Grant lines ($\overline{\text{DMARI}}\text{-}2$, $\overline{\text{DMAGI}}\text{-}2$). Other DMA features include interrupt generation upon completion of DMA transfers, two-dimensional DMA, and DMA chaining for automatic linked DMA transfers.

Multiprocessing

The ADSP-21160M offers powerful features tailored to multiprocessing DSP systems as shown in Figure 4. The external port and link ports provide integrated glueless multiprocessing support.

The external port supports a unified address space (see Figure 2) that allows direct interprocessor accesses of each ADSP-21160M's internal memory. Distributed bus arbitration logic is included on-chip for simple, glueless connection of systems containing up to six ADSP-21160Ms and a host processor. Master processor changeover incurs only one cycle of overhead. Bus arbitration is selectable as either fixed

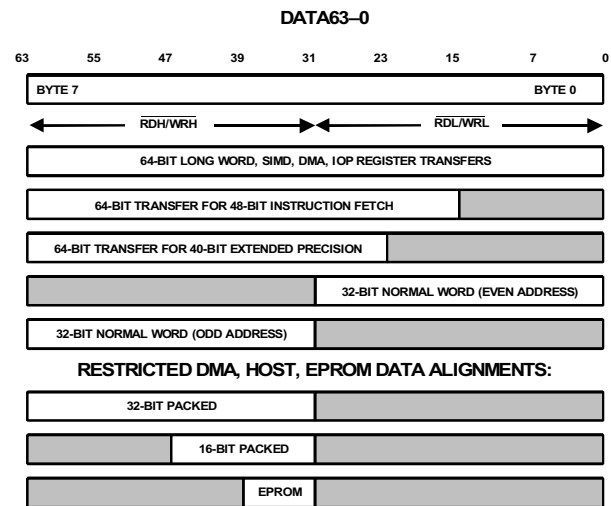

Figure 3. ADSP-21160M External Data Alignment Options

or rotating priority. Bus lock allows indivisible read-modify-write sequences for semaphores. A vector interrupt is provided for interprocessor commands. Maximum throughput for interprocessor data transfer is 320M bytes/s over the external port. Broadcast writes allow simultaneous transmission of data to all ADSP-21160Ms and can be used to implement reflective semaphores.

Six link ports provide for a second method of multiprocessing communications. Each link port can support communications to another ADSP-21160M. Using the links, a large multiprocessor system can be constructed in a 2D or 3D fashion. Systems can use the link ports and cluster multiprocessing concurrently or independently.

Link Ports

The ADSP-21160M features six 8-bit link ports that provide additional I/O capabilities. With the capability of running at 80 MHz rates, each link port can support 80M bytes/s. Link port I/O is especially useful for point-to-point interprocessor communication in multiprocessing systems. The link ports can operate independently and simultaneously. Link port data is packed into 48- or 32-bit words, and can be directly read by the core processor or DMA-transferred to on-chip memory. Each link port has its own double-buffered input and output registers. Clock/acknowledge handshaking controls link port transfers. Transfers are programmable as either transmit or receive. For data throughput information, see link port timing details in Table 18 on page 34.

Serial Ports

The ADSP-21160M features two synchronous serial ports that provide an inexpensive interface to a wide variety of digital and mixed-signal peripheral devices. The serial ports can operate up to half the clock rate of the core, providing each with a maximum data rate of 40M bit/s. Independent

ADSP-21160M

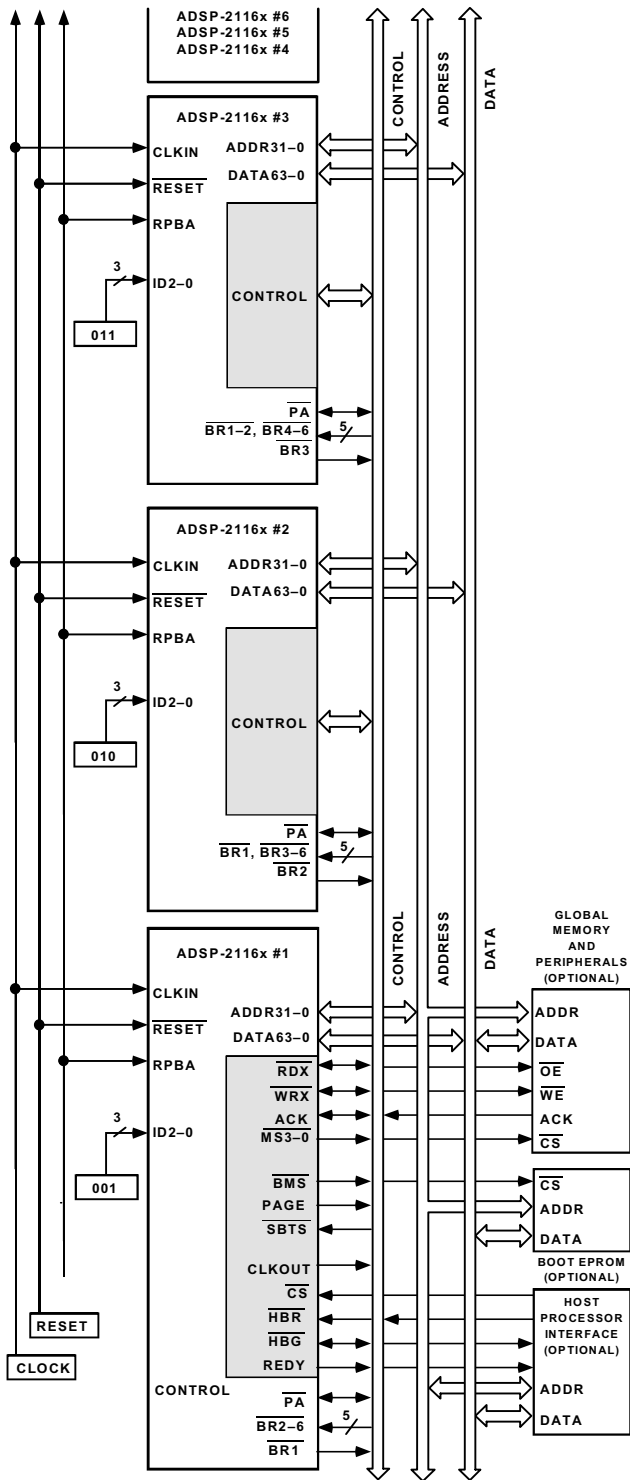

Figure 4. Shared Memory Multiprocessing System

transmit and receive functions provide greater flexibility for serial communications. Serial port data can be automatically transferred to and from on-chip memory via a dedicated DMA. Each of the serial ports offers a TDM multichannel mode. The serial ports can operate with lit-

tle-endian or big-endian transmission formats, with word lengths selectable from 3 bits to 32 bits. They offer selectable synchronization and transmit modes as well as optional μ -law or A-law companding. Serial port clocks and frame syncs can be internally or externally generated.

Host Processor Interface

The ADSP-21160M host interface allows easy connection to standard microprocessor buses, both 16-bit and 32-bit, with little additional hardware required. The host interface is accessed through the ADSP-21160M's external port and is memory-mapped into the unified address space. Four channels of DMA are available for the host interface; code and data transfers are accomplished with low software overhead. The host processor communicates with the ADSP-21160M's external bus with host bus request (HBR), host bus grant (HBG), ready (REDY), acknowledge (ACK), and chip select (CS) signals. The host can directly read and write the internal memory of the ADSP-21160M, and can access the DMA channel setup and mailbox registers. Vector interrupt support provides efficient execution of host commands.

Program Booting

The internal memory of the ADSP-21160M can be booted at system power-up from an 8-bit EPROM, a host processor, or through one of the link ports. Selection of the boot source is controlled by the $\overline{\text{BMS}}$ (Boot Memory Select), EBOOT (EPROM Boot), and LBOOT (Link/Host Boot) pins. 32-bit and 16-bit host processors can be used for booting.

Phased Locked Loop

The ADSP-21160M uses an on-chip PLL to generate the internal clock for the core. Ratios of 2:1, 3:1, and 4:1 between the core and CLKIN are supported. The CLK_CFG pins are used to select the ratio. The CLKIN rate is the rate at which the synchronous external port operates.

Power Supplies

The ADSP-21160M has separate power supply connections for the internal (V_{DDINT}), external (V_{DDEXT}), and analog ($AV_{\text{DD}}/\text{AGND}$) power supplies. The internal and analog supplies must meet the 2.5 V requirement. The external supply must meet the 3.3 V requirement. All external supply pins must be connected to the same supply.

Note that the analog supply (AV_{DD}) powers the ADSP-21160M's clock generator PLL. To produce a stable clock, the system must provide an external circuit to filter the power input to the AV_{DD} pin. Place the filter as close as possible to the pin. For an example circuit, see Figure 5. To prevent noise coupling, use a wide trace for the analog ground (AGND) signal and install a decoupling capacitor as close as possible to the pin.

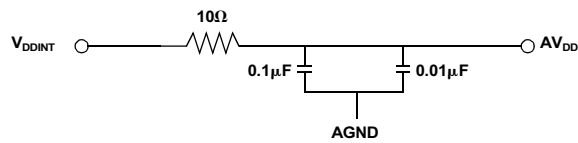

Figure 5. Analog Power (AV_{DD}) Filter Circuit

Development Tools

The ADSP-21160M is supported with a complete set of software and hardware development tools, including Analog Devices' emulators and VisualDSP++¹ development environment. The same emulator hardware that supports other ADSP-2116x DSPs, also fully emulates the ADSP-21160M.

The VisualDSP++ project management environment lets programmers develop and debug an application. This environment includes an easy-to-use assembler that is based on an algebraic syntax; an archiver (librarian/library builder), a linker, a loader, a cycle-accurate instruction-level simulator, a C/C++ compiler, and a C/C++ run-time library that includes DSP and mathematical functions. Two key points for these tools are:

- Compiled ADSP-2116x C/C++ code efficiency—the compiler has been developed for efficient translation of C/C++ code to ADSP-2116x assembly. The DSP has architectural features that improve the efficiency of compiled C/C++ code.
- ADSP-2106x family code compatibility—The assembler has legacy features to ease the conversion of existing ADSP-2106x applications to the ADSP-2116x.

Debugging both C/C++ and assembly programs with the VisualDSP++ debugger, programmers can:

- View mixed C/C++ and assembly code (interleaved source and object information)
- Insert break points
- Set conditional breakpoints on registers, memory, and stacks
- Trace instruction execution
- Perform linear or statistical profiling of program execution
- Fill, dump, and graphically plot the contents of memory
- Source level debugging
- Create custom debugger windows

The VisualDSP++ IDE lets programmers define and manage DSP software development. Its dialog boxes and property pages let programmers configure and manage all

of the ADSP-2116x development tools, including the syntax highlighting in the VisualDSP++ editor. This capability permits:

- Control how the development tools process inputs and generate outputs.
- Maintain a one-to-one correspondence with the tool's command line switches.

Analog Devices' DSP emulators use the IEEE 1149.1 JTAG test access port of the ADSP-21160M processor to monitor and control the target board processor during emulation. The emulator provides full-speed emulation, allowing inspection and modification of memory, registers, and processor stacks. Nonintrusive in-circuit emulation is assured by the use of the processor's JTAG interface—the emulator does not affect target system loading or timing.

In addition to the software and hardware development tools available from Analog Devices, third parties provide a wide range of tools supporting the ADSP-2116x processor family. Hardware tools include ADSP-2116x PC plug-in cards. Third Party software tools include DSP libraries, real-time operating systems, and block diagram design tools.

Designing an Emulator-Compatible DSP Board (Target)

The White Mountain DSP (Product Line of Analog Devices, Inc.) family of emulators are tools that every DSP developer needs to test and debug hardware and software systems. Analog Devices has supplied an IEEE 1149.1 JTAG Test Access Port (TAP) on each JTAG DSP. The emulator uses the TAP to access the internal features of the DSP, allowing the developer to load code, set breakpoints, observe variables, observe memory, and examine registers. The DSP must be halted to send data and commands, but once an operation has been completed by the emulator, the DSP system is set running at full speed with no impact on system timing.

To use these emulators, the target's design must include the interface between an Analog Devices' JTAG DSP and the emulation header on a custom DSP target board.

Target Board Header

The emulator interface to an Analog Devices' JTAG DSP is a 14-pin header, as shown in Figure 6. The customer must supply this header on the target board in order to communicate with the emulator. The interface consists of a standard dual row 0.025" square post header, set on 0.1" × 0.1" spacing, with a minimum post length of 0.235". Pin 3 is the key position used to prevent the pod from being inserted backwards. This pin must be clipped on the target board.

¹VisualDSP++ is a registered trademark of Analog Devices, Inc.

ADSP-21160M

Also, the clearance (length, width, and height) around the header must be considered. Leave a clearance of at least 0.15" and 0.10" around the length and width of the header, and reserve a height clearance to attach and detach the pod connector.

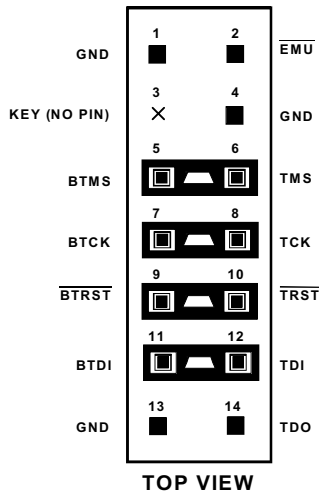

Figure 6. JTAG Target Board Connector for JTAG Equipped Analog Devices DSP (Jumpers in Place)

As can be seen in Figure 6, there are two sets of signals on the header. There are the standard JTAG signals TMS, TCK, TDI, TDO, TRST, and EMU used for emulation purposes (via an emulator). There are also secondary JTAG signals BTMS, BTCK, BTDI, and BTRST that are optionally used for board-level (boundary scan) testing.

When the emulator is not connected to this header, place jumpers across BTMS, BTCK, BTRST, and BTDI as shown in Figure 7. This holds the JTAG signals in the correct state to allow the DSP to run free. Remove all the jumpers when connecting the emulator to the JTAG header.

JTAG Emulator Pod Connector

Figure 8 details the dimensions of the JTAG pod connector at the 14-pin target end. Figure 9 displays the keep-out area for a target board header. The keep-out area allows the pod connector to properly seat onto the target board header. This board area should contain no components (chips, resistors, capacitors, etc.). The dimensions are referenced to the center of the 0.25" square post pin.

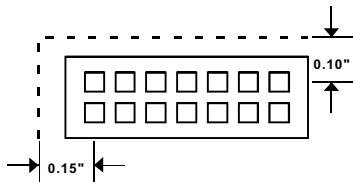

Figure 9. JTAG Pod Connector Keep-Out Area

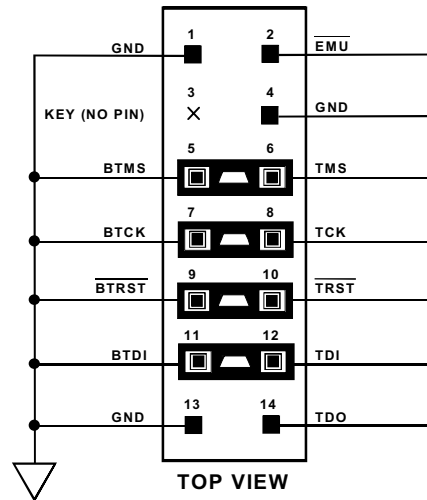

Figure 7. JTAG Target Board Connector with No Local Boundary Scan

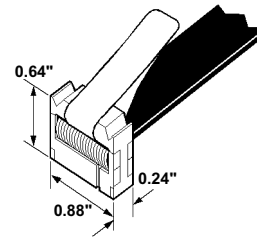

Figure 8. JTAG Pod Connector Dimensions

Design-for-Emulation Circuit Information

For details on target board design issues including: single processor connections, multiprocessor scan chains, signal buffering, signal termination, and emulator pod logic, see the EE-68: Analog Devices JTAG Emulation Technical Reference on the Analog Devices website—use site search on “EE-68” (www.analog.com). This document is updated regularly to keep pace with improvements to emulator support.

Additional Information

This data sheet provides a general overview of the ADSP-21160M architecture and functionality. For detailed information on the ADSP-2116x Family core architecture and instruction set, refer to the ADSP-2116x SHARC DSP Hardware Reference.

PIN FUNCTION DESCRIPTIONS

ADSP-21160M pin definitions are listed below. Inputs identified as synchronous (S) must meet timing requirements with respect to CLKIN (or with respect to TCK for TMS, TDI). Inputs identified as asynchronous (A) can be asserted asynchronously to CLKIN (or to TCK for TRST).

Unused inputs should be tied or pulled to VDD or GND, except for ADDR31–0, DATA63–0, FLAG3–0, and inputs that have internal pull-up or pull-down resistors (\overline{PA} , \overline{ACK} , \overline{BRST} , \overline{PAGE} , \overline{CLKOUT} , $\overline{MS3-0}$, \overline{RDx} , \overline{WRx} , \overline{DMARx} , \overline{DMAGx} , \overline{DTx} , \overline{DRx} , \overline{TCLKx} , \overline{RCLKx} , $\overline{LxDAT7-0}$, \overline{LxCLK} , \overline{LxACK} , \overline{TMS} , \overline{TRST} and \overline{TDI})—these pins can be left floating. These pins have a logic-level hold circuit (only enabled on the ADSP-21160M with ID2–0 = 00x) that prevents input from floating internally.

The following symbols appear in the Type column of Table 2: A = Asynchronous, G = Ground, I = Input, O = Output, P = Power Supply, S = Synchronous, (A/D) = Active Drive, (O/D) = Open Drain, and T = Three-State (when \overline{SBTS} is asserted, or when the ADSP-21160M is a bus slave).

Table 2. Pin Function Descriptions

Pin	Type	Function
ADDR31–0	I/O/T	External Bus Address. The ADSP-21160M outputs addresses for external memory and peripherals on these pins. In a multiprocessor system, the bus master outputs addresses for read/writes of the internal memory or IOP registers of other ADSP-21160Ms. The ADSP-21160M inputs addresses when a host processor or multiprocessing bus master is reading or writing its internal memory or IOP registers. A keeper latch on the DSP's ADDR31–0 pins maintains the input at the level it was last driven (only enabled on the ADSP-21160M with ID2–0 = 00x).
DATA63–0	I/O/T	External Bus Data. The ADSP-21160M inputs and outputs data and instructions on these pins. Pull-up resistors on unused DATA pins are not necessary. A keeper latch on the DSP's DATA63–0 pins maintains the input at the level it was last driven (only enabled on the ADSP-21160M with ID2–0 = 00x).
$\overline{MS3-0}$	O/T	Memory Select Lines. These outputs are asserted (low) as chip selects for the corresponding banks of external memory. Memory bank size must be defined in the SYSCON control register. The $\overline{MS3-0}$ outputs are decoded memory address lines. In asynchronous access mode, the $\overline{MS3-0}$ outputs transition with the other address outputs. In synchronous access modes, the $\overline{MS3-0}$ outputs assert with the other address lines; however, they de-assert after the first CLKIN cycle in which \overline{ACK} is sampled asserted.
\overline{RDL}	I/O/T	Memory Read Low Strobe. \overline{RDL} is asserted whenever ADSP-21160M reads from the low word of external memory or from the internal memory of other ADSP-21160Ms. External devices, including other ADSP-21160Ms, must assert \overline{RDL} for reading from the low word of ADSP-21160M internal memory. In a multiprocessing system, \overline{RDL} is driven by the bus master.
\overline{RDH}	I/O/T	Memory Read High Strobe. \overline{RDH} is asserted whenever ADSP-21160M reads from the high word of external memory or from the internal memory of other ADSP-21160Ms. External devices, including other ADSP-21160Ms, must assert \overline{RDH} for reading from the high word of ADSP-21160M internal memory. In a multiprocessing system, \overline{RDH} is driven by the bus master.
\overline{WRL}	I/O/T	Memory Write Low Strobe. \overline{WRL} is asserted when ADSP-21160M writes to the low word of external memory or internal memory of other ADSP-21160Ms. External devices must assert \overline{WRL} for writing to ADSP-21160M's low word of internal memory. In a multiprocessing system, \overline{WRL} is driven by the bus master.
\overline{WRH}	I/O/T	Memory Write High Strobe. \overline{WRH} is asserted when ADSP-21160M writes to the high word of external memory or internal memory of other ADSP-21160Ms. External devices must assert \overline{WRH} for writing to ADSP-21160M's high word of internal memory. In a multiprocessing system, \overline{WRH} is driven by the bus master.
PAGE	O/T	DRAM Page Boundary. The ADSP-21160M asserts this pin to signal that an external DRAM page boundary has been crossed. DRAM page size must be defined in the ADSP-21160M's memory control register (WAIT). DRAM can only be implemented in external memory Bank 0; the PAGE signal can only be activated for Bank 0 accesses. In a multiprocessing system PAGE is output by the bus master. A keeper latch on the DSP's PAGE pin maintains the output at the level it was last driven (only enabled on the ADSP-21160M with ID2–0 = 00x).

ADSP-21160M

Table 2. Pin Function Descriptions (Continued)

Pin	Type	Function
$\overline{\text{BRST}}$	I/O/T	Sequential Burst Access. $\overline{\text{BRST}}$ is asserted by ADSP-21160M or a host to indicate that data associated with consecutive addresses is being read or written. A slave device samples the initial address and increments an internal address counter after each transfer. The incremented address is not pipelined on the bus. If the burst access is a read from host to ADSP-21160M, ADSP-21160M automatically increments the address as long as $\overline{\text{BRST}}$ is asserted. $\overline{\text{BRST}}$ is asserted after the initial access of a burst transfer. It is asserted for every cycle after that, except for the last data request cycle (denoted by $\overline{\text{RDx}}$ or $\overline{\text{WRx}}$ asserted and $\overline{\text{BRST}}$ negated). A keeper latch on the DSP's $\overline{\text{BRST}}$ pin maintains the input at the level it was last driven (only enabled on the ADSP-21160M with ID2-0 = 00x).
ACK	I/O/S	Memory Acknowledge. External devices can de-assert ACK (low) to add wait states to an external memory access. ACK is used by I/O devices, memory controllers, or other peripherals to hold off completion of an external memory access. The ADSP-21160M deasserts ACK as an output to add wait states to a synchronous access of its internal memory. A keeper latch on the DSP's ACK pin maintains the input at the level it was last driven (only enabled on the ADSP-21160M with ID2-0 = 00x).
$\overline{\text{SBTS}}$	I/S	Suspend Bus and Three-State. External devices can assert $\overline{\text{SBTS}}$ (low) to place the external bus address, data, selects, and strobes in a high impedance state for the following cycle. If the ADSP-21160M attempts to access external memory while $\overline{\text{SBTS}}$ is asserted, the processor will halt and the memory access will not be completed until $\overline{\text{SBTS}}$ is deasserted. $\overline{\text{SBTS}}$ should only be used to recover from host processor and/or ADSP-21160M deadlock or used with a DRAM controller.
$\overline{\text{IRQ2-0}}$	I/A	Interrupt Request Lines. These are sampled on the rising edge of CLKIN and may be either edge-triggered or level-sensitive.
FLAG3-0	I/O/A	Flag Pins. Each is configured via control bits as either an input or output. As an input, it can be tested as a condition. As an output, it can be used to signal external peripherals.
TIMEXP	O	Timer Expired. Asserted for four CLKIN cycles when the timer is enabled and TCOUNT decrements to zero.
$\overline{\text{HBR}}$	I/A	Host Bus Request. Must be asserted by a host processor to request control of the ADSP-21160M's external bus. When $\overline{\text{HBR}}$ is asserted in a multiprocessing system, the ADSP-21160M that is bus master will relinquish the bus and assert $\overline{\text{HBG}}$. To relinquish the bus, the ADSP-21160M places the address, data, select, and strobe lines in a high impedance state. $\overline{\text{HBR}}$ has priority over all ADSP-21160M bus requests ($\overline{\text{BR6-1}}$) in a multiprocessing system.
$\overline{\text{HBG}}$	I/O	Host Bus Grant. Acknowledges an $\overline{\text{HBR}}$ bus request, indicating that the host processor may take control of the external bus. $\overline{\text{HBG}}$ is asserted (held low) by the ADSP-21160M until $\overline{\text{HBR}}$ is released. In a multiprocessing system, $\overline{\text{HBG}}$ is output by the ADSP-21160M bus master and is monitored by all others.
$\overline{\text{CS}}$	I/A	Chip Select. Asserted by host processor to select the ADSP-21160M.
REDY	O (O/D)	Host Bus Acknowledge. The ADSP-21160M deasserts REDY (low) to add waitstates to a host access when $\overline{\text{CS}}$ and $\overline{\text{HBR}}$ inputs are asserted.
$\overline{\text{DMAR1}}$	I/A	DMA Request 1 (DMA Channel 11). Asserted by external port devices to request DMA services.
$\overline{\text{DMAR2}}$	I/A	DMA Request 2 (DMA Channel 12). Asserted by external port devices to request DMA services.
ID2-0	I	Multiprocessing ID. Determines which multiprocessing bus request ($\overline{\text{BR1-6}}$) is used by ADSP-21160M. ID = 001 corresponds to $\overline{\text{BR1}}$, ID = 010 corresponds to $\overline{\text{BR2}}$, and so on. Use ID = 000 or ID = 001 in single-processor systems. These lines are a system configuration selection which should be hardwired or only changed at reset.
$\overline{\text{DMAG1}}$	O/T	DMA Grant 1 (DMA Channel 11). Asserted by ADSP-21160M to indicate that the requested DMA starts on the next cycle. Driven by bus master only.

Table 2. Pin Function Descriptions (Continued)

Pin	Type	Function
$\overline{\text{DMAG2}}$	O/T	DMA Grant 2 (DMA Channel 12). Asserted by ADSP-21160M to indicate that the requested DMA starts on the next cycle. Driven by bus master only.
$\overline{\text{BR6-1}}$	I/O/S	Multiprocessing Bus Requests. Used by multiprocessing ADSP-21160Ms to arbitrate for bus mastership. An ADSP-21160M only drives its own $\overline{\text{BRx}}$ line (corresponding to the value of its ID2–0 inputs) and monitors all others. In a multiprocessor system with less than six ADSP-21160Ms, the unused $\overline{\text{BRx}}$ pins should be pulled high; the processor's own $\overline{\text{BRx}}$ line must not be pulled high or low because it is an output.
RPBA	I/S	Rotating Priority Bus Arbitration Select. When RPBA is high, rotating priority for multiprocessor bus arbitration is selected. When RPBA is low, fixed priority is selected. This signal is a system configuration selection which must be set to the same value on every ADSP-21160M. If the value of RPBA is changed during system operation, it must be changed in the same CLKIN cycle on every ADSP-21160M.
$\overline{\text{PA}}$	I/O/T	Priority Access. Asserting its $\overline{\text{PA}}$ pin allows an ADSP-21160M bus slave to interrupt background DMA transfers and gain access to the external bus. $\overline{\text{PA}}$ is connected to all ADSP-21160Ms in the system. If access priority is not required in a system, the $\overline{\text{PA}}$ pin should be left unconnected.
DTx	O	Data Transmit (Serial Ports 0, 1). Each DT pin has a 50 k Ω internal pull-up resistor.
DRx	I	Data Receive (Serial Ports 0, 1). Each DR pin has a 50 k Ω internal pull-up resistor.
TCLKx	I/O	Transmit Clock (Serial Ports 0, 1). Each TCLK pin has a 50 k Ω internal pull-up resistor.
RCLKx	I/O	Receive Clock (Serial Ports 0, 1). Each RCLK pin has a 50 k Ω internal pull-up resistor.
TFSx	I/O	Transmit Frame Sync (Serial Ports 0, 1).
RFSx	I/O	Receive Frame Sync (Serial Ports 0, 1).
LxDAT7–0	I/O	Link Port Data (Link Ports 0–5). Each LxDAT pin has a 50 k Ω internal pull-down resistor that is enabled or disabled by the LPDRD bit of the LCTL0–1 register.
LxCLK	I/O	Link Port Clock (Link Ports 0–5). Each LxCLK pin has a 50 k Ω internal pull-down resistor that is enabled or disabled by the LPDRD bit of the LCTL0–1 register.
LxACK	I/O	Link Port Acknowledge (Link Ports 0–5). Each LxACK pin has a 50 k Ω internal pull-down resistor that is enabled or disabled by the LPDRD bit of the LCOM register.
EBOOT	I	EPROM Boot Select. For a description of how this pin operates, see Table 3 . This signal is a system configuration selection that should be hardwired.
LBOOT	I	Link Boot. For a description of how this pin operates, see Table 3 . This signal is a system configuration selection that should be hardwired.
$\overline{\text{BMS}}$	I/O/T	Boot Memory Select. Serves as an output or input as selected with the EBOOT and LBOOT pins; see Table 3 . This input is a system configuration selection that should be hardwired.
CLKIN	I	Local Clock In. CLKIN is the ADSP-21160M clock input. The ADSP-21160M external port cycles at the frequency of CLKIN. The instruction cycle rate is a multiple of the CLKIN frequency; it is programmable at power-up. CLKIN may not be halted, changed, or operated below the specified frequency.
CLK_CFG3–0	I	Core/CLKIN Ratio Control. ADSP-21160M core clock (instruction cycle) rate is equal to $n \times \text{CLKIN}$ where n is user-selectable to 2, 3, or 4, using the CLK_CFG3–0 inputs. For clock configuration definitions, see the <i>RESET & CLKIN</i> section of the <i>System Design</i> chapter of the <i>ADSP-21160 SHARC DSP Hardware Reference</i> manual.
CLKOUT	O/T	Local Clock Out. CLKOUT is driven at the CLKIN frequency by the current bus master. This output is three-stated when the ADSP-21160M is not the bus master, or when the host controls the bus ($\overline{\text{HBG}}$ asserted). A keeper latch on the DSP's CLKOUT pin maintains the output at the level it was last driven (only enabled on the ADSP-21160M with ID2–0 = 00x).
$\overline{\text{RESET}}$	I/A	Processor Reset. Resets the ADSP-21160M to a known state and begins execution at the program memory location specified by the hardware reset vector address. The $\overline{\text{RESET}}$ input must be asserted (low) at power-up.

ADSP-21160M

Table 2. Pin Function Descriptions (Continued)

Pin	Type	Function
TCK	I	Test Clock (JTAG). Provides a clock for JTAG boundary scan.
TMS	I/S	Test Mode Select (JTAG). Used to control the test state machine. TMS has a 20 kΩ internal pull-up resistor.
TDI	I/S	Test Data Input (JTAG). Provides serial data for the boundary scan logic. TDI has a 20 kΩ internal pull-up resistor.
TDO	O	Test Data Output (JTAG). Serial scan output of the boundary scan path.
$\overline{\text{TRST}}$	I/A	Test Reset (JTAG). Resets the test state machine. $\overline{\text{TRST}}$ must be asserted (pulsed low) after power-up or held low for proper operation of the ADSP-21160M. $\overline{\text{TRST}}$ has a 20 kΩ internal pull-up resistor.
$\overline{\text{EMU}}$	O (O/D)	Emulation Status. Must be connected to the ADSP-21160M emulator target board connector only. EMU has a 50 kΩ internal pull-up resistor.
$\overline{\text{CIF}}$	O/T	Core Instruction Fetch. Signal is active low when an external instruction fetch is performed. Driven by bus master only. Three-state when host is bus master.
V_{DDINT}	P	Core Power Supply. Nominally 2.5 V dc and supplies the DSP's core processor (40 pins).
V_{DDEXT}	P	I/O Power Supply. Nominally 3.3 V dc (46 pins).
AV_{DD}	P	Analog Power Supply. Nominally 2.5 V dc and supplies the DSP's internal PLL (clock generator). This pin has the same specifications as V_{DDINT} , except that added filtering circuitry is required. For more information, see Power Supplies on page 6.
AGND	G	Analog Power Supply Return.
GND	G	Power Supply Return. (83 pins)
NC		Do Not Connect. Reserved pins that must be left open and unconnected (5 pins).

Table 3. Boot Mode Selection

EBOOT	LBOOT	$\overline{\text{BMS}}$	Booting Mode
1	0	Output	EPROM (Connect $\overline{\text{BMS}}$ to EPROM chip select.)
0	0	1 (Input)	Host Processor
0	1	1 (Input)	Link Port
0	0	0 (Input)	No Booting. Processor executes from external memory.
0	1	0 (Input)	Reserved
1	1	x (Input)	Reserved

ADSP-21160M SPECIFICATIONS

RECOMMENDED OPERATING CONDITIONS

Signal	K Grade Parameter ¹	Min	Max	Unit
V _{DDINT}	Internal (Core) Supply Voltage	2.37	2.63	V
AV _{DD}	Analog (PLL) Supply Voltage	2.37	2.63	V
V _{DDEXT}	External (I/O) Supply Voltage	3.13	3.47	V
V _{IH1}	High Level Input Voltage ² , @ V _{DDEXT} = Max	2.2	V _{DDEXT} + 0.5	V
V _{IH2}	High Level Input Voltage ³ , @ V _{DDEXT} = Max	2.3	V _{DDEXT} + 0.5	V
V _{IL}	Low Level Input Voltage ^{2,3} , @ V _{DDEXT} = Min	-0.5	0.8	V
T _{CASE}	Case Operating Temperature ⁴	0	85	°C

¹ Specifications subject to change without notice.

² Applies to input and bidirectional pins: DATA63-0, ADDR31-0, RD \bar{x} , WR \bar{x} , ACK, SBTS, IRQ2-0, FLAG3-0, HBG, CS, DMAR1, DMAR2, BR6-1, ID2-0, RPBA, PA, BRST, TFS0, TFS1, RFS0, RFS1, LxDAT3-0, LxCLK, LxACK, EBOOT, LBOOT, BMS, TMS, TDI, TCK, HBR, DR0, DR1, TCLK0, TCLK1, RCLK0, RCLK1.

³ Applies to input pins: CLKIN, RESET, TRST.

⁴ See [Environmental Conditions on page 45](#) for information on thermal specifications.

ELECTRICAL CHARACTERISTICS

Parameter ¹	Test Conditions	Min	Max	Unit
V _{OH}	High Level Output Voltage ²	@ V _{DDEXT} = Min, I _{OH} = -2.0 mA ³	2.4	V
V _{OL}	Low Level Output Voltage ²	@ V _{DDEXT} = Min, I _{OL} = 4.0 mA ³	0.4	V
I _{IH}	High Level Input Current ^{4,5,6}	@ V _{DDEXT} = Max, V _{IN} = V _{DD} Max	10	μA
I _{IL}	Low Level Input Current ⁴	@ V _{DDEXT} = Max, V _{IN} = 0 V	10	μA
I _{ILPU1}	Low Level Input Current Pull-Up ¹ ⁵	@ V _{DDEXT} = Max, V _{IN} = 0 V	250	μA
I _{ILPU2}	Low Level Input Current Pull-Up ² ⁶	@ V _{DDEXT} = Max, V _{IN} = 0 V	500	μA
I _{OZH}	Three-State Leakage Current ^{7,8,9,10}	@ V _{DDEXT} = Max, V _{IN} = V _{DD} Max	10	μA
I _{OZL}	Three-State Leakage Current ⁷	@ V _{DDEXT} = Max, V _{IN} = 0 V	10	μA
I _{OZHPD}	Three-State Leakage Current Pull-Down ¹⁰	@ V _{DDEXT} = Max, V _{IN} = V _{DD} Max	250	μA
I _{OZLPU1}	Three-State Leakage Current Pull-Up ¹ ⁸	@ V _{DDEXT} = Max, V _{IN} = 0 V	250	μA
I _{OZLPU2}	Three-State Leakage Current Pull-Up ² ⁹	@ V _{DDEXT} = Max, V _{IN} = 0 V	500	μA
I _{OZHA}	Three-State Leakage Current ¹¹	@ V _{DDEXT} = Max, V _{IN} = V _{DD} Max	25	μA
I _{OZLA}	Three-State Leakage Current ¹¹	@ V _{DDEXT} = Max, V _{IN} = 0 V	4	mA
I _{DD-INPEAK}	Supply Current (Internal) ¹²	t _{CCLK} = 12.5 ns, V _{DDINT} = Max	1400	mA
I _{DD-INHIGH}	Supply Current (Internal) ¹³	t _{CCLK} = 12.5 ns, V _{DDINT} = Max	875	mA
I _{DD-INLOW}	Supply Current (Internal) ¹⁴	t _{CCLK} = 12.5 ns, V _{DDINT} = Max	625	mA
I _{DD-IDLE}	Supply Current (Idle) ¹⁵	t _{CCLK} = 12.5 ns, V _{DDINT} = Max	80	mA
AI _{DD}	Supply Current (Analog) ¹⁶	@ AV _{DD} = Max	10	mA
C _{IN}	Input Capacitance ^{17,18}	f _{IN} = 1 MHz, T _{CASE} = 25°C, V _{IN} = 2.5 V	4.7	pF

¹ Specifications subject to change without notice.

² Applies to output and bidirectional pins: DATA63-0, ADDR31-0, MS3-0, RD \bar{x} , WR \bar{x} , PAGE, CLKOUT, ACK, FLAG3-0, TIMEXP, HBG, REDY, DMAG1, DMAG2, BR6-1, PA, BRST, CIF, DT0, DT1, TCLK0, TCLK1, RCLK0, RCLK1, TFS0, TFS1, RFS0, RFS1, LxDAT3-0, LxCLK, LxACK, BMS, TDO, EMU.

³ See [Output Drive Currents on page 42](#) for typical drive current capabilities.

⁴ Applies to input pins: ACK, SBTS, IRQ2-0, HBR, CS, ID2-0, RPBA, EBOOT, LBOOT, CLKIN, RESET, TCK, CLK_CFG3-0.

ADSP-21160M

- ⁵Applies to input pins with internal pull-ups: DR0, DR1.
- ⁶Applies to input pins with internal pull-ups: DMAR \bar{x} , TMS, TDI, TRST.
- ⁷Applies to three-statable pins: DATA63-0, ADDR31-0, PAGE, CLKOUT, ACK, FLAG3-0, REDY, HBG, BMS, BR6-I, TFS \bar{x} , RFS \bar{x} , TDO.
- ⁸Applies to three-statable pins with internal pull-ups: DT \bar{x} , TCLK \bar{x} , RCLK \bar{x} , EMU.
- ⁹Applies to three-statable pins with internal pull-ups: MS3-0, RD \bar{x} , WR \bar{x} , DMAG \bar{x} , PA, CIF.
- ¹⁰Applies to three-statable pins with internal pull-downs: LxDAT7-0, LxCLK, LxACK.
- ¹¹Applies to ACK pulled up internally with 2 k Ω during reset or ID2-0 = 00x.
- ¹²The test program used to measure I_{DD-INPEAK} represents worst case processor operation and is not sustainable under normal application conditions. Actual internal power measurements made using typical applications are less than specified. [For more information, see Power Dissipation on page 42.](#)
- ¹³I_{DDINHIGH} is a composite average based on a range of high activity code. [For more information, see Power Dissipation on page 42.](#)
- ¹⁴I_{DDINLOW} is a composite average based on a range of low activity code. [For more information, see Power Dissipation on page 42.](#)
- ¹⁵Idle denotes ADSP-21160M state during execution of IDLE instruction. [For more information, see Power Dissipation on page 42.](#)
- ¹⁶Characterized, but not tested.
- ¹⁷Applies to all signal pins.
- ¹⁸Guaranteed, but not tested.

ABSOLUTE MAXIMUM RATINGS

Internal (Core) Supply Voltage (V _{DDINT}) ¹	. . . -0.3 V to +3.0 V
Analog (PLL) Supply Voltage (A _{VDD}) -0.3 V to +3.0 V
External (I/O) Supply Voltage (V _{DDEXT})	. . . -0.3 V to +4.6 V
Input Voltage -0.5 V to V _{DDEXT} + 0.5 V
Output Voltage Swing -0.5 V to V _{DDEXT} + 0.5 V
Load Capacitance 200 pF
Storage Temperature Range -65°C to +150°C
Lead Temperature (5 seconds) 185°C

¹Stresses greater than those listed above may cause permanent damage to the device. These are stress ratings only. Functional operation of the device at these or any other conditions greater than those indicated in the operational sections of this specification is not implied. Exposure to absolute maximum rating conditions for extended periods may affect device reliability.

ESD SENSITIVITY

CAUTION:

ESD (electrostatic discharge) sensitive device. Electrostatic charges as high as 4000V readily accumulate on the human body and test equipment and can discharge without detection. Although the ADSP-21160M features proprietary ESD protection circuitry, permanent damage may occur on devices subjected to high-energy electrostatic discharges. Therefore, proper ESD precautions are recommended to avoid performance degradation or loss of functionality.



Timing Specifications

The ADSP-21160M's internal clock switches at higher frequencies than the system input clock (CLKIN). To generate the internal clock, the DSP uses an internal phase-locked loop (PLL). This PLL-based clocking minimizes the skew between the system clock (CLKIN) signal and the DSP's internal clock (the clock source for the external port logic and I/O pads).

The ADSP-21160M's internal clock (a multiple of CLKIN) provides the clock signal for timing internal memory, processor core, link ports, serial ports, and external port (as required for read/write strobes in asynchronous access mode). During reset, program the ratio between the DSP's internal clock frequency and external (CLKIN) clock frequency with the CLK_CFG3–0 pins. Even though the internal clock is the clock source for the external port, the external port clock always switches at the CLKIN frequency. To determine switching frequencies for the serial and link ports, divide down the internal clock, using the programmable divider control of each port (TDIV_x/RDIV_x for the serial ports and L_xCLKD1–0 for the link ports).

Note the following definitions of various clock periods that are a function of CLKIN and the appropriate ratio control:

- $t_{\text{CLK}} = (t_{\text{CK}}) / \text{CR}$
- $t_{\text{LCLK}} = (t_{\text{CLK}}) \times \text{LR}$
- $t_{\text{SCLK}} = (t_{\text{CLK}}) \times \text{SR}$

Where:

- LCLK = Link Port Clock
- SCLK = Serial Port Clock
- t_{CK} = CLKIN Clock Period
- t_{CLK} = (Processor) Core Clock Period
- t_{LCLK} = Link Port Clock Period
- t_{SCLK} = Serial Port Clock Period
- CR = Core/CLKIN Ratio (2, 3, or 4:1, determined by CLK_CFG3–0 at reset)
- LR = Link Port/Core Clock Ratio (1, 2, 3, or 4:1, determined by L_xCLKD)
- SR = Serial Port/Core Clock Ratio (wide range, determined by \times CLKDIV)

Use the exact timing information given. Do not attempt to derive parameters from the addition or subtraction of others. While addition or subtraction would yield meaningful results for an individual device, the values given in this data sheet reflect statistical variations and worst cases. Consequently, it is not meaningful to add parameters to derive longer times.

See [Figure 32](#) under Test Conditions for voltage reference levels.

Switching Characteristics specify how the processor changes its signals. Circuitry external to the processor must be designed for compatibility with these signal characteristics. Switching characteristics describe what the processor will do in a given circumstance. Use switching characteristics to ensure that any timing requirement of a device connected to the processor (such as memory) is satisfied.

Timing Requirements apply to signals that are controlled by circuitry external to the processor, such as the data input for a read operation. Timing requirements guarantee that the processor operates correctly with other devices.

ADSP-21160M

Clock Input

Table 4. Clock Input

Parameter	80 MHz		Unit
	Min	Max	
<i>Timing Requirements:</i>			
t_{CK} CLKIN Period	25	80	ns
t_{CKL} CLKIN Width Low	10.5	40	ns
t_{CKH} CLKIN Width High	10.5	40	ns
t_{CKRF} CLKIN Rise/Fall (0.4V–2.0V)		3	ns

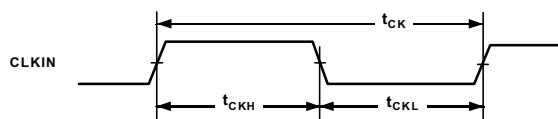

Figure 10. Clock Input

Reset

Table 5. Reset

Parameter	Min	Max	Unit
<i>Timing Requirements:</i>			
t_{WRST} RESET Pulsewidth Low ¹	$4t_{CK}$		ns
t_{SRST} RESET Setup Before CLKIN High ²	8		ns

¹Applies after the power-up sequence is complete. At power-up, the processor's internal phase-locked loop requires no more than 100 ms while RESET is low, assuming stable VDD and CLKIN (not including start-up time of external clock oscillator).

²Only required if multiple ADSP-21160Ms must come out of reset synchronous to CLKIN with program counters (PC) equal. Not required for multiple ADSP-21160Ms communicating over the shared bus (through the external port), because the bus arbitration logic automatically synchronizes itself after reset.

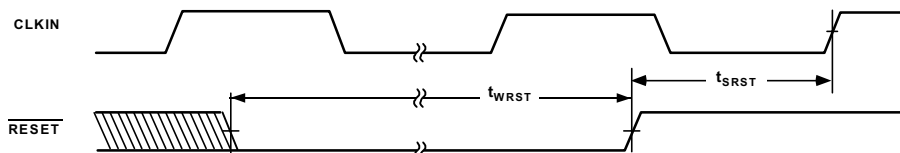

Figure 11. Reset

Interrupts

Table 6. Interrupts

Parameter	Min	Max	Unit
<i>Timing Requirements:</i>			
t_{SIR}	$\overline{IRQ2-0}$ Setup Before CLKIN High ¹		ns
t_{HIR}	$\overline{IRQ2-0}$ Hold After CLKIN High ¹		ns
t_{IPW}	$\overline{IRQ2-0}$ Pulsewidth ²		$2 + t_{CK}$

¹Only required for $IRQx$ recognition in the following cycle.

²Applies only if t_{SIR} and t_{HIR} requirements are not met.

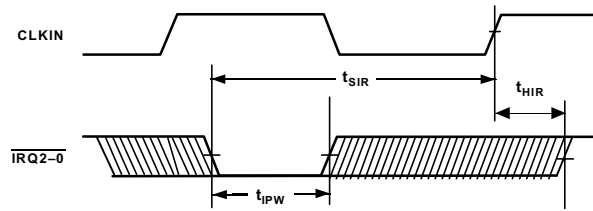

Figure 12. Interrupts

Timer

Table 7. Timer

Parameter	Min	Max	Unit
<i>Switching Characteristic:</i>			
t_{DTEX}	CLKIN High to TIMEXP		ns

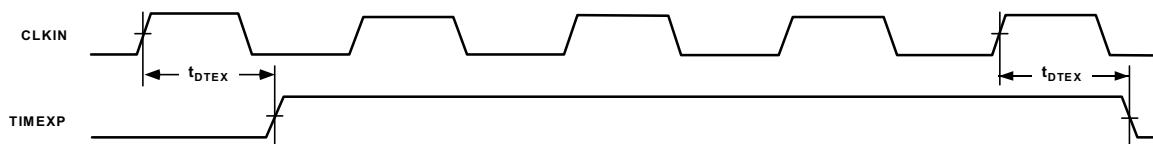

Figure 13. Timer

ADSP-21160M

Flags

Table 8. Flags

Parameter	Min	Max	Unit
<i>Timing Requirements:</i>			
t_{SFI}	FLAG3-0 IN Setup Before CLKIN High ¹		ns
t_{HFI}	FLAG3-0 IN Hold After CLKIN High ¹		ns
t_{DWRFI}	FLAG3-0 IN Delay After $\overline{RDx}/\overline{WRx}$ Low ¹		ns
t_{HFIWR}	FLAG3-0 IN Hold After $\overline{RDx}/\overline{WRx}$ Deasserted ¹		ns
<i>Switching Characteristics:</i>			
t_{DFO}	FLAG3-0 OUT Delay After CLKIN High		ns
t_{HFO}	FLAG3-0 OUT Hold After CLKIN High		ns
t_{DFOE}	CLKIN High to FLAG3-0 OUT Enable		ns
t_{DFOD}	CLKIN High to FLAG3-0 OUT Disable		ns

¹ Flag inputs meeting these setup and hold times for instruction cycle N will affect conditional instructions in instruction cycle N+2.

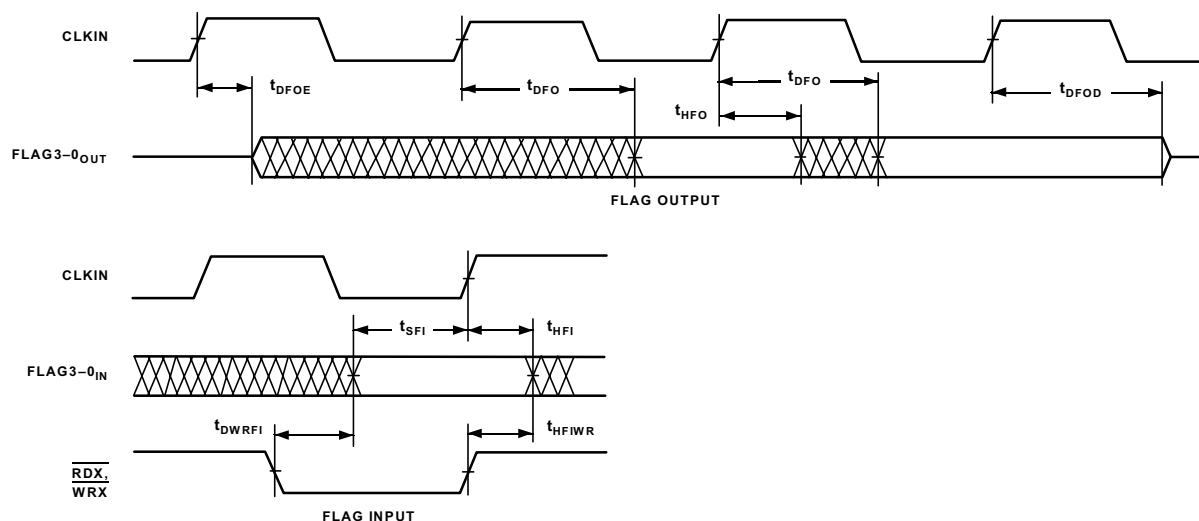

Figure 14. Flags

Memory Read—Bus Master

Use these specifications for asynchronous interfacing to memories (and memory-mapped peripherals) without reference to CLKIN. These specifications apply when the ADSP-21160M is the bus master accessing external

memory space in asynchronous access mode. Note that timing for ACK, DATA, \overline{RDx} , \overline{WRx} , and \overline{DMAG} strobe timing parameters only applies to asynchronous access mode.

Table 9. Memory Read—Bus Master

Parameter	Min	Max	Unit	
<i>Timing Requirements:</i>				
t_{DAD}	Address, \overline{CIF} , Selects Delay to Data Valid ^{1,2}		$t_{CK} - 0.25t_{CCLK} - 11 + W$	ns
t_{DRLD}	\overline{RDx} Low to Data Valid ^{1,3}		$0.75t_{CK} - 11 + W$	ns
t_{HDA}	Data Hold from Address, Selects ⁴		0	ns
t_{SDS}	Data Setup to \overline{RDx} High ¹		8	ns
t_{HDRH}	Data Hold from \overline{RDx} High ^{3,4}		1	ns
t_{DAAK}	ACK Delay from Address, Selects ^{2,5}		$t_{CK} - 0.5t_{CCLK} - 12 + W$	ns
t_{DSAK}	ACK Delay from \overline{RDx} Low ^{3,5}		$t_{CK} - 0.75t_{CCLK} - 11 + W$	ns
t_{SAKC}	ACK Setup to CLKIN ^{3,5}		$0.5t_{CCLK} + 3$	ns
t_{HAKC}	ACK Hold After CLKIN ³		1	ns
<i>Switching Characteristics:</i>				
t_{DRHA}	Address, \overline{CIF} , Selects Hold After \overline{RDx} High ³		$0.25t_{CCLK} - 1 + H$	ns
t_{DARL}	Address, \overline{CIF} , Selects to \overline{RDx} Low ²		$0.25t_{CCLK} - 3$	ns
t_{RW}	\overline{RDx} Pulse width ³		$t_{CK} - 0.5t_{CCLK} - 1 + W$	ns
t_{RWR}	\overline{RDx} High to \overline{WRx} , \overline{RDx} , \overline{DMAGx} Low ³		$0.5t_{CCLK} - 1 + HI$	ns

W = (number of wait states specified in WAIT register) $\times t_{CK}$.

HI = t_{CK} (if an address hold cycle or bus idle cycle occurs, as specified in WAIT register; otherwise $HI = 0$).

H = t_{CK} (if an address hold cycle occurs as specified in WAIT register; otherwise $H = 0$).

¹Data Delay/Setup: User must meet t_{DAD} , t_{DRLD} , or t_{SDS} .

²The falling edge of \overline{MSx} , \overline{BMS} is referenced.

³Note that timing for ACK, DATA, \overline{RDx} , \overline{WRx} , and \overline{DMAG} strobe timing parameters only applies to asynchronous access mode.

⁴Data Hold: User must meet t_{HDA} or t_{HDRH} in asynchronous access mode. See [Example System Hold Time Calculation on page 44](#) for the calculation of hold times given capacitive and dc loads.

⁵ACK Delay/Setup: User must meet t_{DAAK} , t_{DSAK} , or t_{SAKC} for deassertion of ACK (Low), all three specifications must be met for assertion of ACK (High).

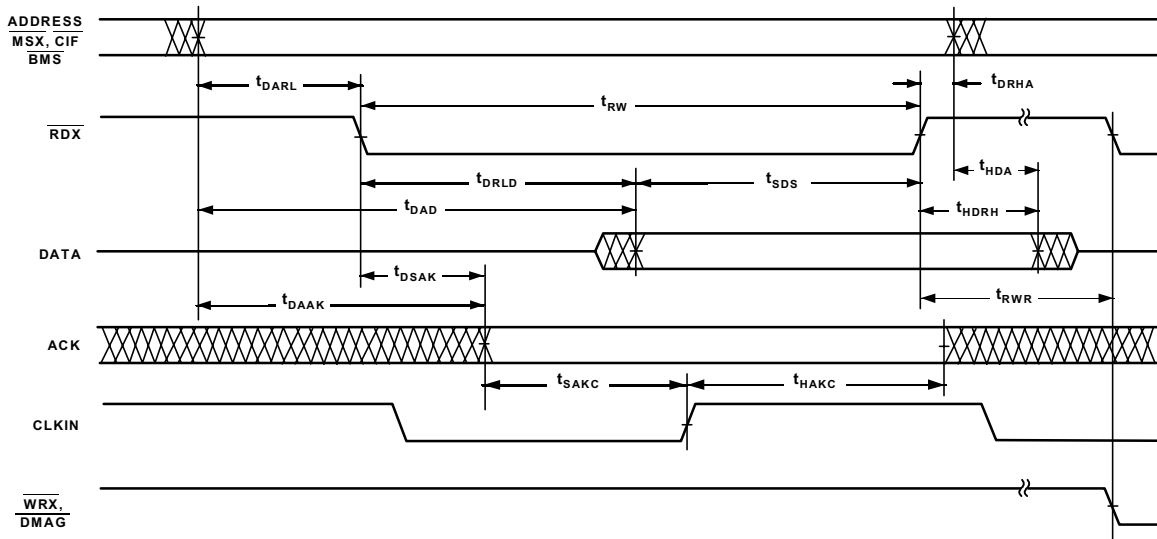

Figure 15. Memory Read—Bus Master

ADSP-21160M

Memory Write—Bus Master

Use these specifications for asynchronous interfacing to memories (and memory-mapped peripherals) without reference to CLKIN. These specifications apply when the ADSP-21160M is the bus master accessing external

memory space in asynchronous access mode. Note that timing for ACK, DATA, \overline{RDx} , \overline{WRx} , and \overline{DMAG} strobe timing parameters only applies to asynchronous access mode.

Table 10. Memory Write—Bus Master

Parameter	Min	Max	Unit
<i>Timing Requirements:</i>			
t_{DAACK} ACK Delay from Address, Selects ^{1,2}		$t_{CK} - 0.5t_{CCLK} - 12 + W$	ns
t_{DSAK} ACK Delay from \overline{WRx} Low ^{1,3}		$t_{CK} - 0.75t_{CCLK} - 11 + W$	ns
t_{SAKC} ACK Setup to CLKIN ^{1,3}	$0.5t_{CCLK} + 3$		ns
t_{HAKC} ACK Hold After CLKIN ^{1,3}	1		ns
<i>Switching Characteristics:</i>			
t_{DAWH} Address, \overline{CIF} , Selects to \overline{WRx} Deasserted ^{2,3}	$t_{CK} - 0.25t_{CCLK} - 3 + W$		ns
t_{DAWL} Address, \overline{CIF} , Selects to \overline{WRx} Low ²	$0.25t_{CCLK} - 3$		ns
t_{WW} \overline{WRx} Pulse width ³	$t_{CK} - 0.5t_{CCLK} - 1 + W$		ns
t_{DDWH} Data Setup before \overline{WRx} High ³	$t_{CK} - 0.25t_{CCLK} - 12.5 + W$		ns
t_{DWHa} Address Hold after \overline{WRx} Deasserted ³	$0.25t_{CCLK} - 1 + H$		ns
t_{DWHd} Data Hold after \overline{WRx} Deasserted ³	$0.25t_{CCLK} - 1 + H$		ns
t_{DATRWH} Data Disable after \overline{WRx} Deasserted ^{3,4}	$0.25t_{CCLK} - 2 + H$	$0.25t_{CCLK} + 2 + H$	ns
t_{WWR} \overline{WRx} High to \overline{WRx} , \overline{RDx} , \overline{DMAGx} Low ³	$0.5t_{CCLK} - 1 + HI$		ns
t_{DDWR} Data Disable before \overline{WRx} or \overline{RDx} Low	$0.25t_{CCLK} - 1 + I$		ns
t_{WDE} \overline{WRx} Low to Data Enabled	$-0.25t_{CCLK} - 1$		ns

$W = (\text{number of wait states specified in WAIT register}) \times t_{CK}$.

$H = t_{CK}$ (if an address hold cycle occurs, as specified in WAIT register; otherwise $H = 0$).

$HI = t_{CK}$ (if an address hold cycle or bus idle cycle occurs, as specified in WAIT register; otherwise $HI = 0$).

$I = t_{CK}$ (if a bus idle cycle occurs, as specified in WAIT register; otherwise $I = 0$).

¹ ACK Delay/Setup: User must meet t_{DAACK} or t_{DSAK} or t_{SAKC} for deassertion of ACK (Low), all three specifications must be met for assertion of ACK (High).

² The falling edge of \overline{MSx} , \overline{BMS} is referenced.

³ Note that timing for ACK, DATA, \overline{RDx} , \overline{WRx} , and \overline{DMAG} strobe timing parameters only applies to asynchronous access mode.

⁴ See [Example System Hold Time Calculation on page 44](#) for calculation of hold times given capacitive and dc loads.

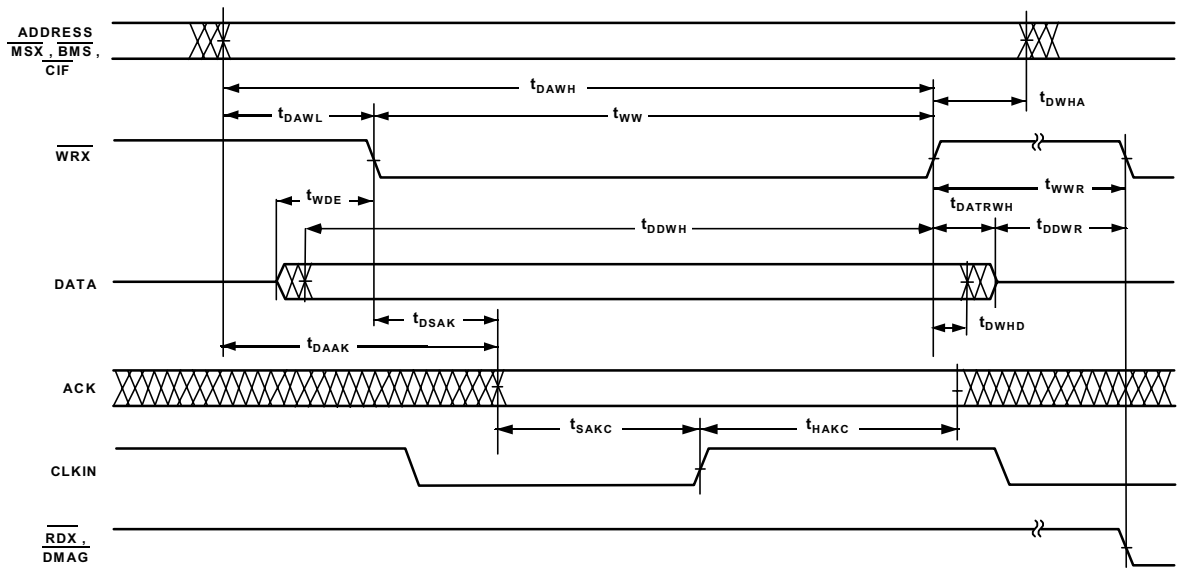

Figure 16. Memory Write—Bus Master

ADSP-21160M

Synchronous Read/Write—Bus Master

Use these specifications for interfacing to external memory systems that require CLKIN—relative timing or for accessing a slave ADSP-21160M (in multiprocessor memory space). These synchronous switching characteristics are also valid during asynchronous memory reads and writes except where noted (see [Memory Read—Bus Master on page 19](#) and [Memory Write—Bus Master on page 20](#)).

When accessing a slave ADSP-21160M, these switching characteristics must meet the slave’s timing requirements for synchronous read/writes (see [Synchronous Read/Write—Bus Slave on page 24](#)). The slave ADSP-21160M must also meet these (bus master) timing requirements for data and acknowledge setup and hold times.

Table 11. Synchronous Read/Write—Bus Master

Parameter	Min	Max	Unit
<i>Timing Requirements:</i>			
t _{SSDATI} Data Setup Before CLKIN ¹	5.5		ns
t _{HSDATI} Data Hold After CLKIN ¹	1		ns
t _{SACKC} ACK Setup Before CLKIN ¹	0.5t _{CCLK} + 3		ns
t _{HACKC} ACK Hold After CLKIN ¹	1		ns
<i>Switching Characteristics:</i>			
t _{DADD0} Address, \overline{MS}_x , \overline{BMS} , \overline{BRST} , \overline{CIF} Delay After CLKIN		10	ns
t _{HADD0} Address, \overline{MS}_x , \overline{BMS} , \overline{BRST} , \overline{CIF} Hold After CLKIN	1.5		ns
t _{DPGO} PAGE Delay After CLKIN	1.5	11	ns
t _{DRDO} \overline{RD}_x High Delay After CLKIN ¹	0.25t _{CCLK} - 1	0.25t _{CCLK} + 9	ns
t _{DWRO} \overline{WR}_x High Delay After CLKIN ¹	0.25t _{CCLK} - 1	0.25t _{CCLK} + 9	ns
t _{DRWL} $\overline{RD}_x/\overline{WR}_x$ Low Delay After CLKIN	0.25t _{CCLK} - 1	0.25t _{CCLK} + 9	ns
t _{DDATO} Data Delay After CLKIN		12.5	ns
t _{HDATO} Data Hold After CLKIN	1.5		ns
t _{DACKMO} ACK Delay After CLKIN ²	0.25t _{CCLK} + 3	0.25t _{CCLK} + 9	ns
t _{ACKMTR} ACK Disable Before CLKIN ²	0.25t _{CCLK} - 3		ns
t _{DCKOO} CLKOUT Delay After CLKIN	2	5	ns
t _{CKOP} CLKOUT Period	t _{CK} - 1	t _{CK} ³ + 1	ns
t _{CKWH} CLKOUT Width High	t _{CK} /2 - 2	t _{CK} /2 + 2 ³	ns
t _{CKWL} CLKOUT Width Low	t _{CK} /2 - 2	t _{CK} /2 + 2 ³	ns

¹Note that timing for ACK, DATA, \overline{RD}_x , \overline{WR}_x , and DMAG strobe timing parameters only applies to synchronous access mode.

²Applies to broadcast write, master precharge of ACK.

³Applies only when the DSP drives a bus operation; CLKOUT held inactive or three-state otherwise, For more information, see the System Design chapter in the *ADSP-2116x SHARC DSP Hardware Reference*.

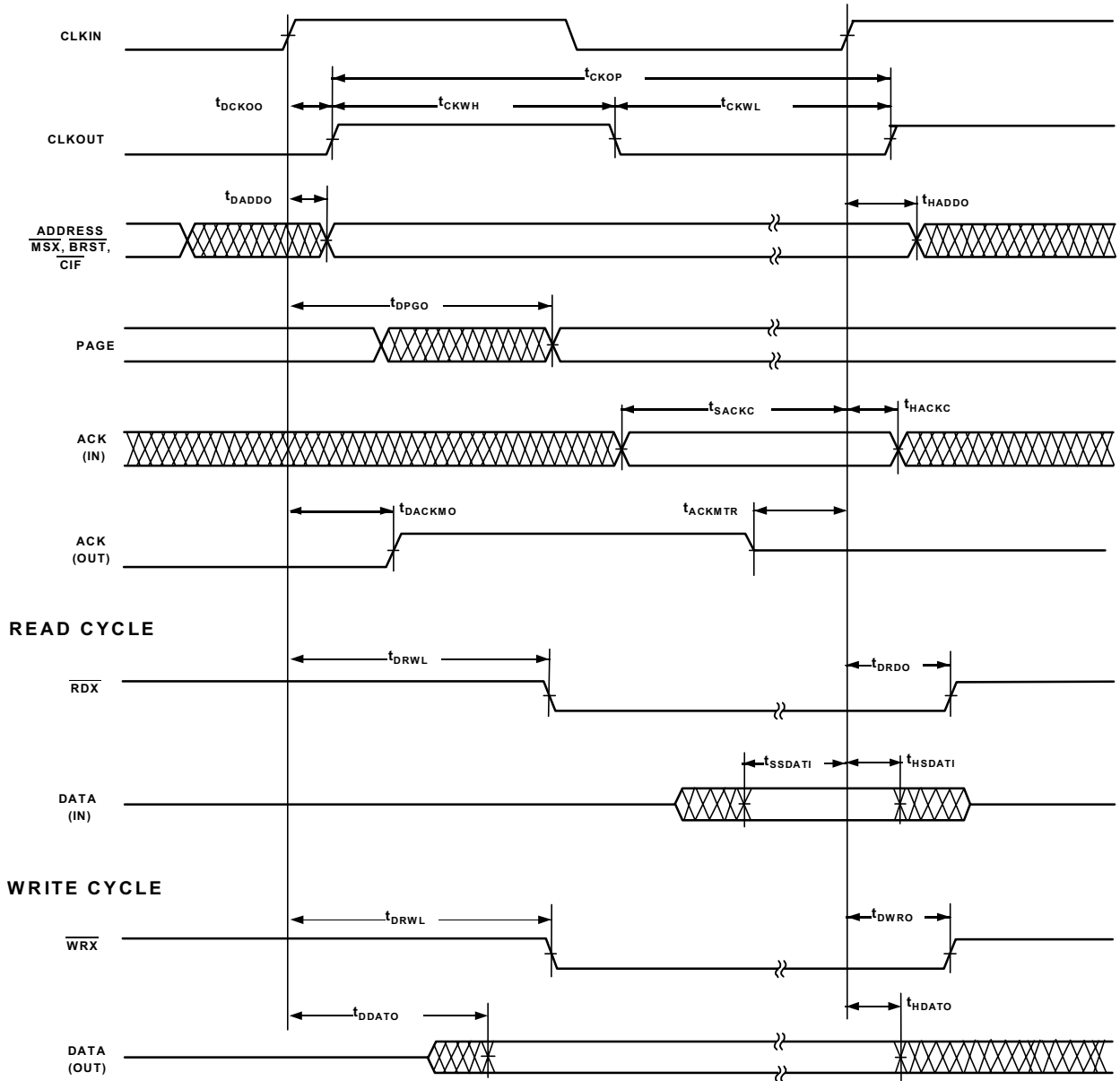

Figure 17. Synchronous Read/Write—Bus Master

ADSP-21160M

Synchronous Read/Write—Bus Slave

Use these specifications for ADSP-21160M bus master accesses of a slave’s IOP registers or internal memory (in multiprocessor memory space). The bus master must meet these (bus slave) timing requirements.

Table 12. Synchronous Read/Write—Bus Slave

Parameter		Min	Max	Unit
<i>Timing Requirements:</i>				
t _{SADDI}	Address, $\overline{\text{BRST}}$ Setup Before CLKIN	5		ns
t _{HADDI}	Address, $\overline{\text{BRST}}$ Hold After CLKIN	1		ns
t _{SRWI}	$\overline{\text{RDx}}/\overline{\text{WRx}}$ Setup Before CLKIN	5		ns
t _{HRWI}	$\overline{\text{RDx}}/\overline{\text{WRx}}$ Hold After CLKIN	1		ns
t _{SSDATI}	Data Setup Before CLKIN	5.5		ns
t _{HSDATI}	Data Hold After CLKIN	1		ns
<i>Switching Characteristics:</i>				
t _{DDATO}	Data Delay After CLKIN		12.5	ns
t _{HDATO}	Data Hold After CLKIN	1.5		ns
t _{DACKC}	ACK Delay After CLKIN		10	ns
t _{HACKO}	ACK Hold After CLKIN	1.5		ns

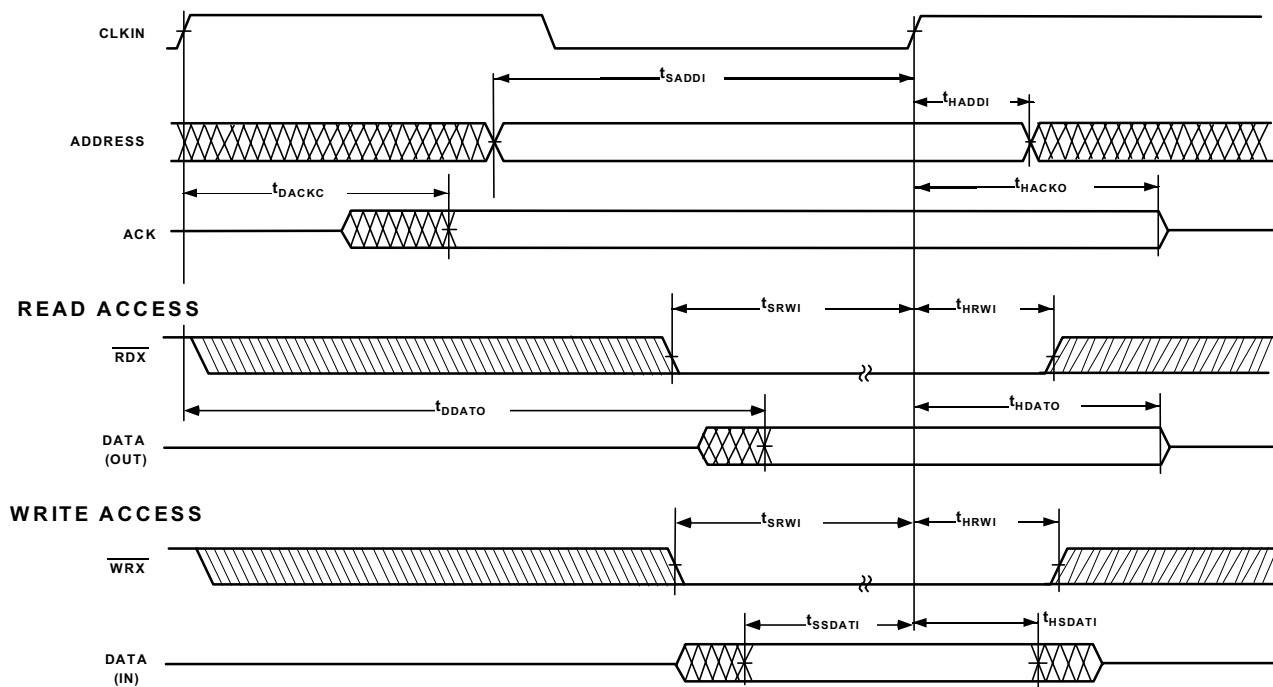

Figure 18. Synchronous Read/Write—Bus Slave

ADSP-21160M

Multiprocessor Bus Request and Host Bus Request

Use these specifications for passing of bus mastership between multiprocessor ADSP-21160Ms (\overline{BRx}) or a host processor (\overline{HBR} , \overline{HBG}).

Table 13. Multiprocessor Bus Request and Host Bus Request

Parameter		Min	Max	Unit
<i>Timing Requirements:</i>				
$t_{HBGRCSV}$	\overline{HBG} Low to $\overline{RDx}/\overline{WRx}/\overline{CS}$ Valid		19	ns
t_{SHBRI}	\overline{HBR} Setup Before CLKIN ¹	6		ns
t_{HHBRI}	\overline{HBR} Hold After CLKIN ¹	1		ns
t_{SHBGI}	\overline{HBG} Setup Before CLK/=]IN	6		ns
t_{HHBGI}	\overline{HBG} Hold After CLKIN High	1		ns
t_{SBRI}	\overline{BRx} , \overline{PA} Setup Before CLKIN	9		ns
t_{HHBRI}	\overline{BRx} , \overline{PA} Hold After CLKIN High	1		ns
t_{SPAI}	\overline{PA} Setup Before CLKIN	9		ns
t_{HPAI}	\overline{PA} Hold After CLKIN High	1		ns
t_{SRPBAI}	RPBA Setup Before CLKIN	6		ns
t_{HRPBAI}	RPBA Hold After CLKIN	2		ns
<i>Switching Characteristics:</i>				
t_{DHBGO}	\overline{HBG} Delay After CLKIN		7	ns
t_{HHBGO}	\overline{HBG} Hold After CLKIN	2		ns
t_{DBRO}	\overline{BRx} Delay After CLKIN		8	ns
t_{HHBRO}	\overline{BRx} Hold After CLKIN	1.5		ns
t_{DPASO}	\overline{PA} Delay After CLKIN, Slave		8	ns
t_{TRPAS}	\overline{PA} Disable After CLKIN, Slave	1.5		ns
t_{DPAMO}	\overline{PA} Delay After CLKIN, Master		$0.25t_{CCLK} + 9$	ns
t_{PATR}	\overline{PA} Disable Before CLKIN, Master	$0.25t_{CCLK} - 5$		ns
t_{DRDYCS}	REDY (O/D) or (A/D) Low from \overline{CS} and \overline{HBR} Low ²		$0.5t_{CK}$	ns
t_{TRDYHG}	REDY (O/D) Disable or REDY (A/D) High from \overline{HBG} ²	$t_{CK} + 25$		ns
t_{ARDYTR}	REDY (A/D) Disable from \overline{CS} or \overline{HBR} High ²		11	ns

¹Only required for recognition in the current cycle.

²(O/D) = open drain, (A/D) = active drive.

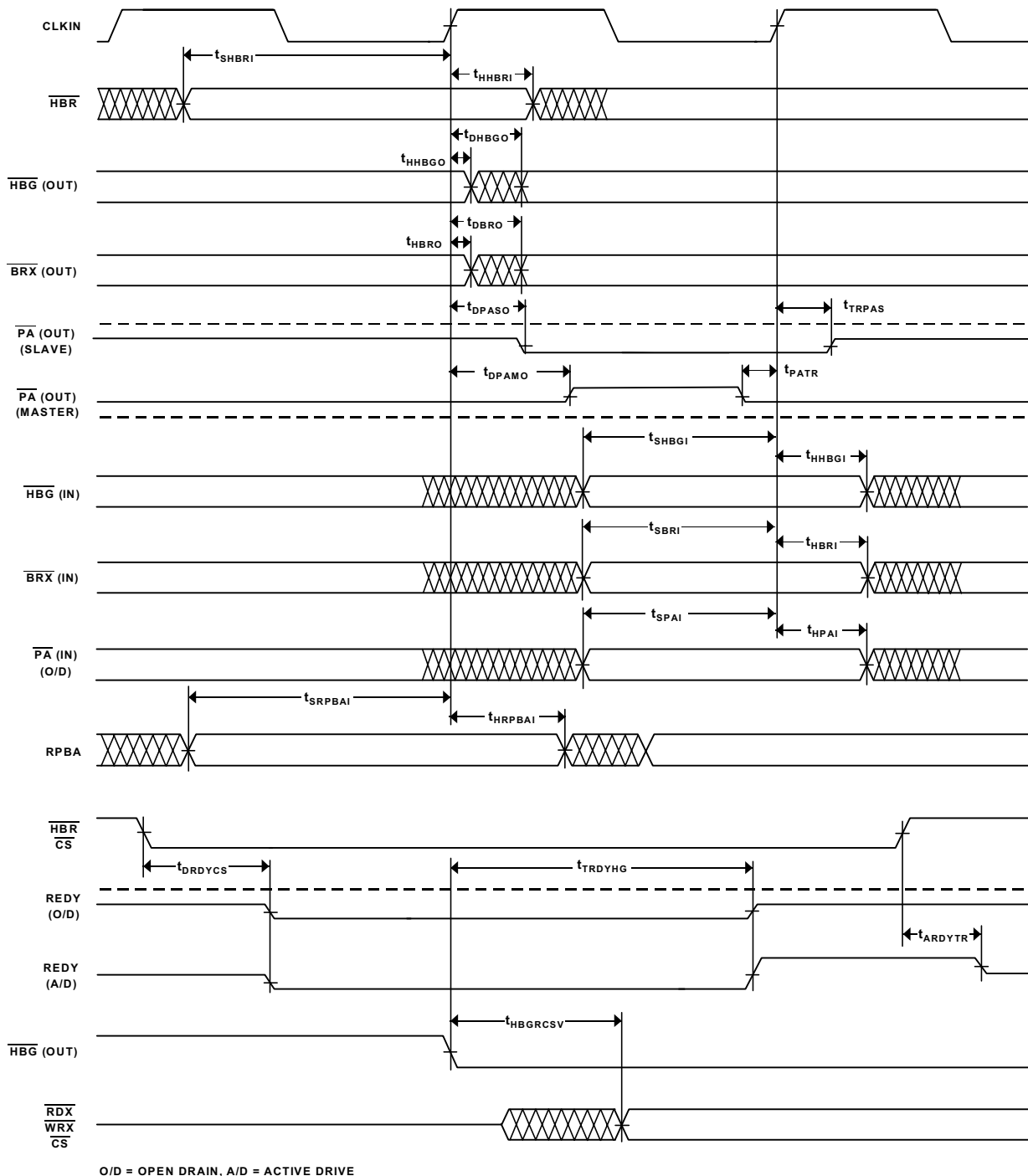

Figure 19. Multiprocessor Bus Request and Host Bus Request

ADSP-21160M

Asynchronous Read/Write—Host to ADSP-21160M

Use these specifications (Table 14 and Table 15) for asynchronous host processor accesses of an ADSP-21160M, after the host has asserted \overline{CS} and \overline{HBR} (low). After \overline{HBG}

is returned by the ADSP-21160M, the host can drive the \overline{RDx} and \overline{WRx} pins to access the ADSP-21160M's internal memory or IOP registers. \overline{HBR} and \overline{HBG} are assumed low for this timing

Table 14. Read Cycle

Parameter	Min	Max	Unit
<i>Timing Requirements:</i>			
t_{SADRDL} Address Setup/ \overline{CS} Low Before \overline{RDx} Low	0		ns
t_{HADRDH} Address Hold/ \overline{CS} Hold Low After \overline{RDx}	2		ns
t_{WRWH} $\overline{RDx}/\overline{WRx}$ High Width	5		ns
$t_{DRDHRDY}$ \overline{RDx} High Delay After REDI (O/D) Disable	0		ns
$t_{DRDHRDY}$ \overline{RDx} High Delay After REDI (A/D) Disable	0		ns
<i>Switching Characteristics:</i>			
$t_{SDATRDY}$ Data Valid Before REDI Disable from Low	2		ns
$t_{DRDYRDL}$ REDI (O/D) or (A/D) Low Delay After \overline{RDx} Low		10	ns
t_{RDYPRD} REDI (O/D) or (A/D) Low Pulsewidth for Read	t_{CK}		ns
t_{HDARWH} Data Disable After \overline{RDx} High	2	6	ns

READ CYCLE

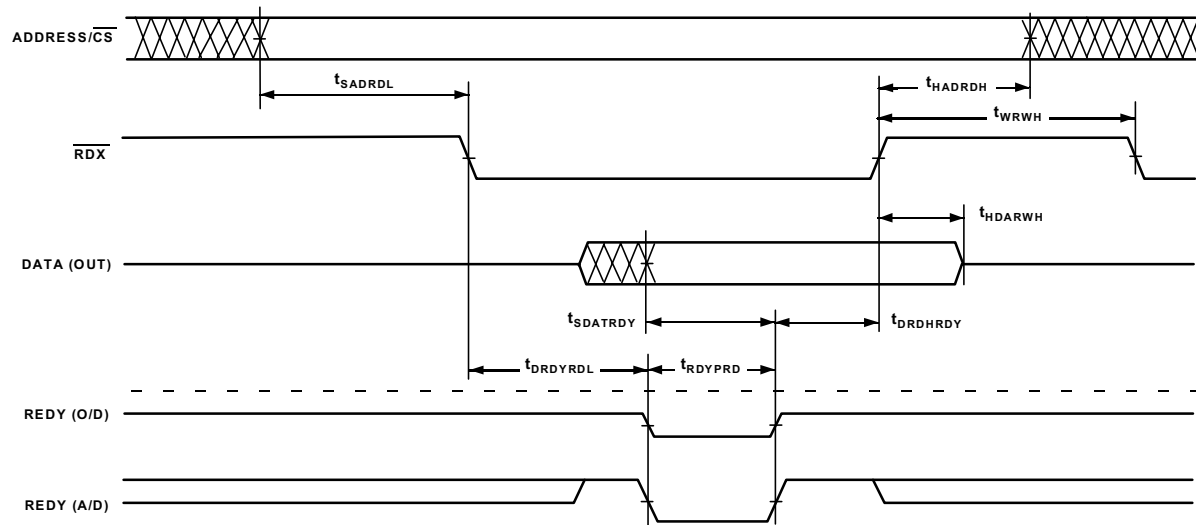

Figure 20. Read Cycle (Asynchronous Read—Host to ADSP-21160M)

Table 15. Write Cycle

Parameter	Min	Max	Unit
<i>Timing Requirements:</i>			
t_{SCSWRL}	CS Low Setup Before \overline{WRx} Low	0	ns
t_{HCSWRH}	CS Low Hold After \overline{WRx} High	0	ns
t_{SADWRH}	Address Setup Before \overline{WRx} High	6	ns
t_{HADWRH}	Address Hold After \overline{WRx} High	2	ns
t_{WWRL}	\overline{WRx} Low Width	7	ns
t_{WRWH}	$\overline{RDx}/\overline{WRx}$ High Width	5	ns
$t_{DWRHRDY}$	\overline{WRx} High Delay After REDY (O/D) or (A/D) Disable	0	ns
t_{SDATWH}	Data Setup Before \overline{WRx} High	5	ns
t_{HDATWH}	Data Hold After \overline{WRx} High	4	ns
<i>Switching Characteristics:</i>			
$t_{DRDYWRL}$	REDY (O/D) or (A/D) Low Delay After $\overline{WRx}/\overline{CS}$ Low	11	ns
t_{RDYPWR}	REDY (O/D) or (A/D) Low Pulsewidth for Write	12	ns

WRITE CYCLE

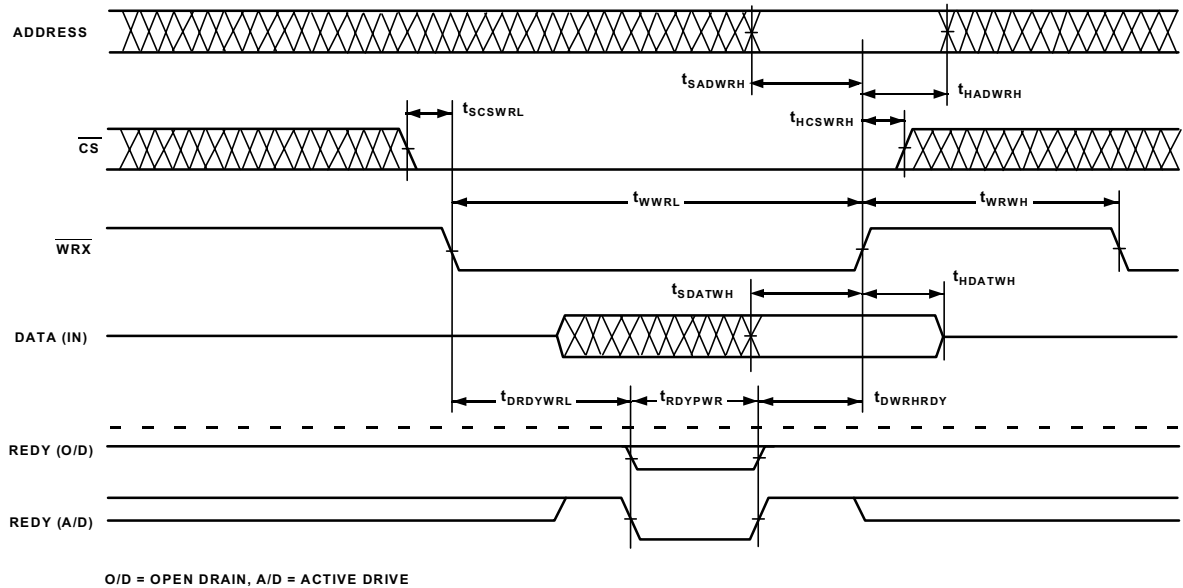

Figure 21. Write Cycle (Asynchronous Write—Host to ADSP-21160M)

ADSP-21160M

Three-State Timing—Bus Master and Bus Slave

These specifications show how the memory interface is disabled (stops driving) or enabled (resumes driving) relative to CLKIN and the $\overline{\text{SBTS}}$ pin. This timing is applicable to bus master transition cycles (BTC) and host transition cycles (HTC) as well as the $\overline{\text{SBTS}}$ pin.

Table 16. Three-State Timing—Bus Slave, $\overline{\text{HBR}}$, $\overline{\text{SBTS}}$

Parameter	Min	Max	Unit
<i>Timing Requirements:</i>			
t_{STSCK} $\overline{\text{SBTS}}$ Setup Before CLKIN	6		ns
t_{HTSCK} $\overline{\text{SBTS}}$ Hold After CLKIN	1		ns
<i>Switching Characteristics:</i>			
t_{MIENA} Address/Select Enable After CLKIN	1.5	9	ns
t_{MIENS} Strobes Enable After CLKIN ¹	1.5	9	ns
t_{MIENHG} $\overline{\text{HBG}}$ Enable After CLKIN	1.5	9	ns
t_{MITRA} Address/Select Disable After CLKIN	$0.25t_{\text{CCLK}} - 1$	$0.25t_{\text{CCLK}} + 4$	ns
t_{MITRS} Strobes Disable After CLKIN ¹	$0.25t_{\text{CCLK}} - 4$	$0.25t_{\text{CCLK}}$	ns
t_{MITRHG} $\overline{\text{HBG}}$ Disable After CLKIN	3.5	8	ns
t_{DATEN} Data Enable After CLKIN ²	1.5	10	ns
t_{DATTR} Data Disable After CLKIN ²	1.5	5	ns
t_{ACKEN} ACK Enable After CLKIN ²	1.5	9	ns
t_{ACKTR} ACK Disable After CLKIN ²	1.5	5	ns
t_{CDCEN} CLKOUT Enable After CLKIN	1.5	9	ns
t_{CDCTR} CLKOUT Disable After CLKIN	$t_{\text{CCLK}} - 3$	$t_{\text{CCLK}} + 1$	ns
t_{MTRHBG} Memory Interface Disable Before $\overline{\text{HBG}}$ Low ³	$t_{\text{CK}} - 6$	$t_{\text{CK}} + 2$	ns
t_{MENHBG} Memory Interface Enable After $\overline{\text{HBG}}$ High ³	$t_{\text{CK}} - 5$	$t_{\text{CK}} + 5$	ns

¹Strobes = $\overline{\text{RDx}}$, $\overline{\text{WRx}}$, $\overline{\text{DMAGx}}$.

²In addition to bus master transition cycles, these specs also apply to bus master and bus slave synchronous read/write.

³Memory Interface = Address, $\overline{\text{RDx}}$, $\overline{\text{WRx}}$, $\overline{\text{MSx}}$, PAGE, $\overline{\text{DMAGx}}$, and $\overline{\text{BMS}}$ (in EPROM boot mode).

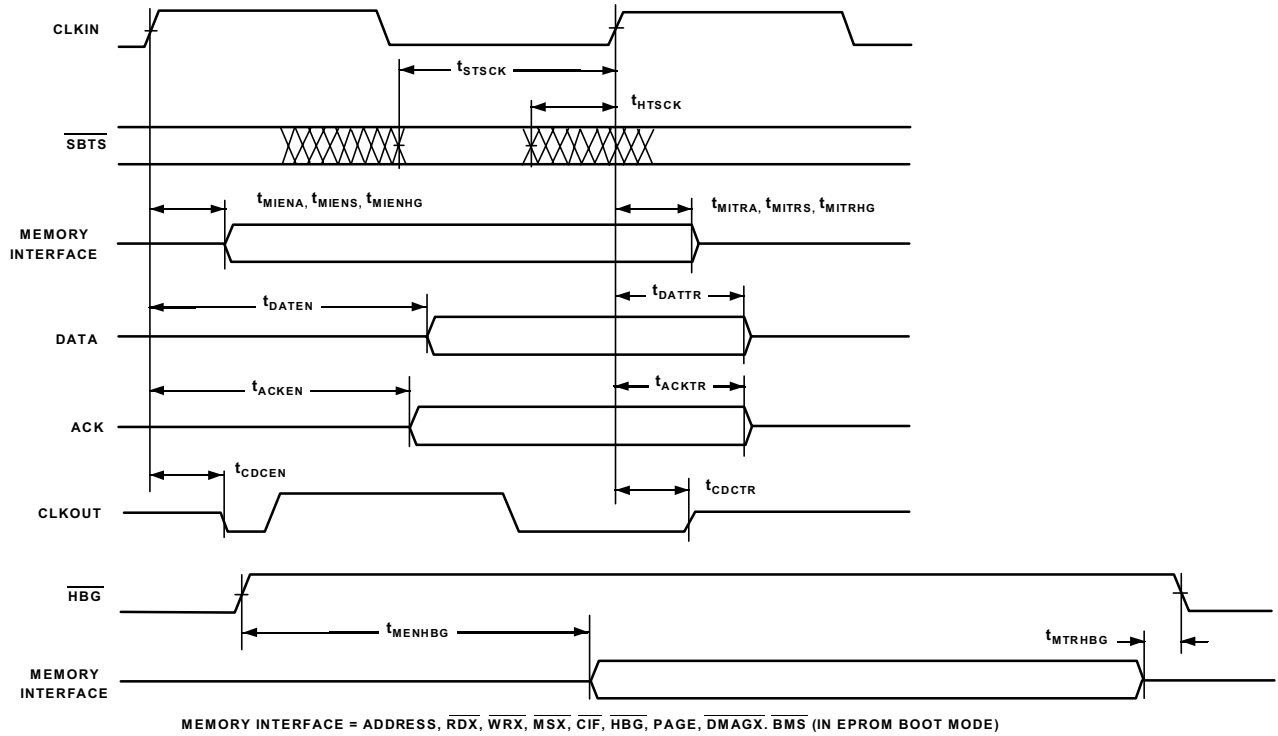

Figure 22. Three-State Timing—Bus Slave, \overline{HBR} , \overline{SBTS}

ADSP-21160M

DMA Handshake

These specifications describe the three DMA handshake modes. In all three modes $\overline{\text{DMAR}}$ is used to initiate transfers. For handshake mode, $\overline{\text{DMAG}}$ controls the latching or enabling of data externally. For external handshake mode, the data transfer is controlled by the ADDR31–0, $\overline{\text{RDx}}$, $\overline{\text{WRx}}$, PAGE, MS3–0, ACK, and DMAG signals. For Paced

Master mode, the data transfer is controlled by ADDR31–0, $\overline{\text{RDx}}$, $\overline{\text{WRx}}$, MS3–0, and ACK (not $\overline{\text{DMAG}}$). For Paced Master mode, the Memory Read-Bus Master, Memory Write-Bus Master, and Synchronous Read/Write-Bus Master timing specifications for ADDR31–0, $\overline{\text{RDx}}$, $\overline{\text{WRx}}$, MS3–0, PAGE, DATA63–0, and ACK also apply.

Table 17. DMA Handshake

Parameter	Min	Max	Unit
<i>Timing Requirements:</i>			
t_{SDRC}	$\overline{\text{DMARx}}$ Setup Before CLKIN ¹		ns
t_{WDR}	$\overline{\text{DMARx}}$ Width Low (Nonsynchronous) ²		ns
t_{SDATDGL}		Data Setup After $\overline{\text{DMAGx}}$ Low ³	ns
t_{HDATDGH}		Data Hold After $\overline{\text{DMAGx}}$ High	ns
t_{DATDRH}		Data Valid After $\overline{\text{DMARx}}$ High ³	ns
t_{DMARLL}		$\overline{\text{DMARx}}$ Low Edge to Low Edge ⁴	ns
t_{DMARH}		$\overline{\text{DMARx}}$ Width High ²	ns
<i>Switching Characteristics:</i>			
t_{DDGL}		$\overline{\text{DMAGx}}$ Low Delay After CLKIN	ns
t_{WDGH}		$\overline{\text{DMAGx}}$ High Width	ns
t_{WDGL}		$\overline{\text{DMAGx}}$ Low Width	ns
t_{HDGC}		$\overline{\text{DMAGx}}$ High Delay After CLKIN	ns
t_{VDATDGH}		Data Valid Before $\overline{\text{DMAGx}}$ High ⁵	ns
t_{DATRDGH}		Data Disable After $\overline{\text{DMAGx}}$ High ⁶	ns
t_{DGWRL}		$\overline{\text{WRx}}$ Low Before $\overline{\text{DMAGx}}$ Low	ns
t_{DGWRH}		$\overline{\text{DMAGx}}$ Low Before $\overline{\text{WRx}}$ High	ns
t_{DGWRR}		$\overline{\text{WRx}}$ High Before $\overline{\text{DMAGx}}$ High ⁷	ns
t_{DGRDL}		$\overline{\text{RDx}}$ Low Before $\overline{\text{DMAGx}}$ Low	ns
t_{DRDGH}		$\overline{\text{RDx}}$ Low Before $\overline{\text{DMAGx}}$ High	ns
t_{DGRDR}		$\overline{\text{RDx}}$ High Before $\overline{\text{DMAGx}}$ High ⁷	ns
t_{DGWR}		$\overline{\text{DMAGx}}$ High to $\overline{\text{WRx}}$, $\overline{\text{RDx}}$, $\overline{\text{DMAGx}}$ Low	ns
t_{DADGH}		Address/Select Valid to $\overline{\text{DMAGx}}$ High	ns
t_{DDGHA}		Address/Select Hold after $\overline{\text{DMAGx}}$ High	ns

W = (number of wait states specified in WAIT register) × t_{CK} .

HI = t_{CK} (if data bus idle cycle occurs, as specified in WAIT register; otherwise HI = 0).

¹ Only required for recognition in the current cycle.

² Maximum throughput using $\overline{\text{DMARx}}/\overline{\text{DMAGx}}$ handshaking equals $t_{\text{WDR}} + t_{\text{DMARH}} = (t_{\text{CLK}} + 4.5) + (t_{\text{CLK}} + 4.5) = 34\text{ns}$ (29.4 MHz). This throughput limit applies to non-synchronous access mode only.

³ t_{SDATDGL} is the data setup requirement if $\overline{\text{DMARx}}$ is not being used to hold off completion of a write. Otherwise, if $\overline{\text{DMARx}}$ low holds off completion of the write, the data can be driven t_{DATDRH} after $\overline{\text{DMARx}}$ is brought high.

⁴ Use t_{DMARLL} if $\overline{\text{DMARx}}$ transitions synchronous with CLKIN. Otherwise, use t_{WDR} and t_{DMARH} .

⁵ t_{VDATDGH} is valid if $\overline{\text{DMARx}}$ is not being used to hold off completion of a read. If $\overline{\text{DMARx}}$ is used to prolong the read, then

$t_{\text{VDATDGH}} = t_{\text{CK}} - .25t_{\text{CLK}} - 8 + (n \times t_{\text{CK}})$ where n equals the number of extra cycles that the access is prolonged.

⁶ See [Example System Hold Time Calculation on page 44](#) for calculation of hold times given capacitive and dc loads.

⁷ This parameter applies for synchronous access mode only.

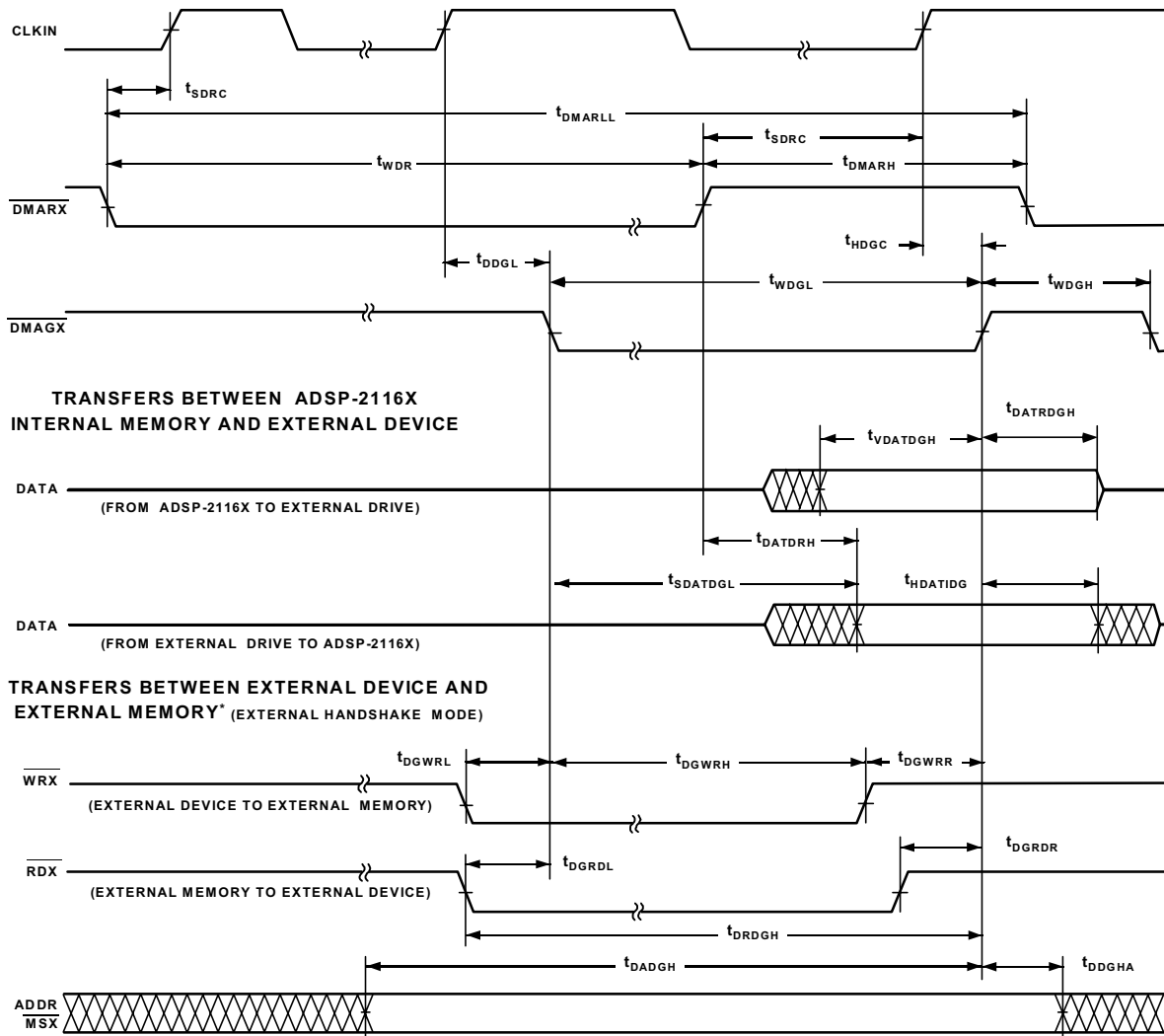

* MEMORY READ BUS MASTER, MEMORY WRITE BUS MASTER, OR SYNCHRONOUS READ/WRITE BUS MASTER TIMING SPECIFICATIONS FOR ADDR31-0, RDX, WRX, MS3-0 AND ACK ALSO APPLY HERE.

Figure 23. DMA Handshake Timing

ADSP-21160M

Link Ports

Calculation of link receiver data setup and hold relative to link clock is required to determine the maximum allowable skew that can be introduced in the transmission path between LDATA and LCLK. Setup skew is the maximum delay that can be introduced in LDATA relative to LCLK (setup skew = $t_{LCLKTWH} \text{ Min} - t_{DLDC} - t_{SLDCL}$). Hold skew is the maximum delay that can be introduced in LCLK relative to LDATA (hold skew = $t_{LCLKTWL} \text{ Min} - t_{HLDG} - t_{HLDCL}$). Calculations made directly from speed specifications will result in unrealistically small skew times because they include multiple tester guardbands.

Note that there is a two-cycle effect latency between the link port enable instruction and the DSP enabling the link port.

Maximum throughput varies across link port transmit/receive pairs. Table 18 shows maximum throughput for all transmit/receive pairs based on setup skew of 0.5 ns (setup skew = $t_{LCLKTWH} \text{ min} - t_{DLDC} - t_{SLDCL} = 0.5 \text{ ns}$). Hold skew results indicate 80 MHz operation across all link ports. All hold time skews are equal to 0.5 ns or greater for all link port transmit/receive pairs at 80 MHz. Based upon these values, all link port transmit/receive pairs can be operated at maximum throughput for LxCLK:CCLK ratios of 2:1, 3:1, and 4:1 at 80 MHz CCLK. To operate all link port transmit/receive pairs at LxCLK:CCLK ratio of 1:1, the core clock frequency must be no greater than 62.5 MHz.

Maximum data throughput values are based upon the reset value of the LAR Link Port Assignment Register (Link Buffer 0 assigned to Link Port 0, Link Buffer 1 assigned to Link Port 1, etc.). Throughputs are not guaranteed for LAR settings other than the reset LAR value. For additional details on LAR, refer to the *ADSP-21160 DSP Hardware Reference* manual.

Table 18. Link Port—Maximum Data Throughput for Transmit/Receive Pairs (Continued)

Transmit Link Port	Receive Link Port	Maximum Operating Frequency (MHz)
2	0	68.97
	1	71.43
	2	71.43
	3	80
	4	76.92
3	5	74.07
	0	64.52
	1	66.67
	2	66.67
	3	71.43
4	4	71.43
	5	71.43
	0	64.52
	1	66.67
	2	66.67
5	3	74.07
	4	74.07
	5	71.43
	0	62.5
	1	66.67
	2	64.52
	3	71.43
	4	71.43
	5	71.43

Table 18. Link Port—Maximum Data Throughput for Transmit/Receive Pairs

Transmit Link Port	Receive Link Port	Maximum Operating Frequency (MHz)
0	0	71.43
	1	74.07
	2	71.43
	3	80
	4	80
	5	76.92
1	0	68.97
	1	71.43
	2	68.97
	3	80
	4	76.92
	5	74.07

Table 19. Link Ports—Receive

Parameter	Min	Max	Unit
<i>Timing Requirements:</i>			
t_{SLDCL} Data Setup Before LCLK Low	2.5		ns
t_{HLDCL} Data Hold After LCLK Low	2.5		ns
t_{LCLKIW} LCLK Period	t_{LCLK}		ns
$t_{LCLKRWL}$ LCLK Width Low	6.0		ns
$t_{LCLKRWH}$ LCLK Width High	6.0		ns
<i>Switching Characteristics:</i>			
t_{DLALC} LACK Low Delay After LCLK High ¹	12	17	ns

¹LACK goes low with t_{DLALC} relative to rise of LCLK after first nibble, but doesn't go low if the receiver's link buffer is not about to fill.

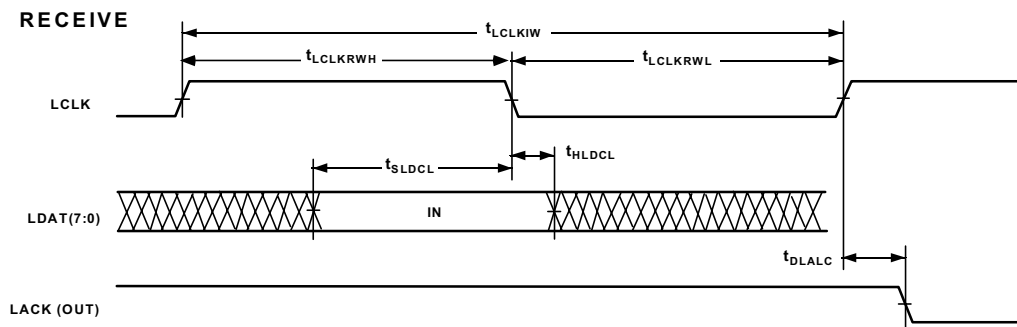

Figure 24. Link Ports—Receive

ADSP-21160M

Table 20. Link Ports—Transmit

Parameter	Min	Max	Unit
<i>Timing Requirements:</i>			
t_{SLACH} LACK Setup Before LCLK High	14		ns
t_{HLACH} LACK Hold After LCLK High	-2		ns
<i>Switching Characteristics:</i>			
t_{DLDC} Data Delay After LCLK High		6.0	ns
t_{HLDCH} Data Hold After LCLK High	-2		ns
$t_{LCLKTWL}$ LCLK Width Low	$0.5t_{LCLK} - 1.5$	$0.5t_{LCLK} + 1.5$	ns
$t_{LCLKTWH}$ LCLK Width High	$0.5t_{LCLK} - 1.5$	$0.5t_{LCLK} + 1.5$	ns
t_{DLACLK} LCLK Low Delay After LACK High	$0.5t_{LCLK} + 5$	$3t_{LCLK} + 11$	ns

TRANSMIT

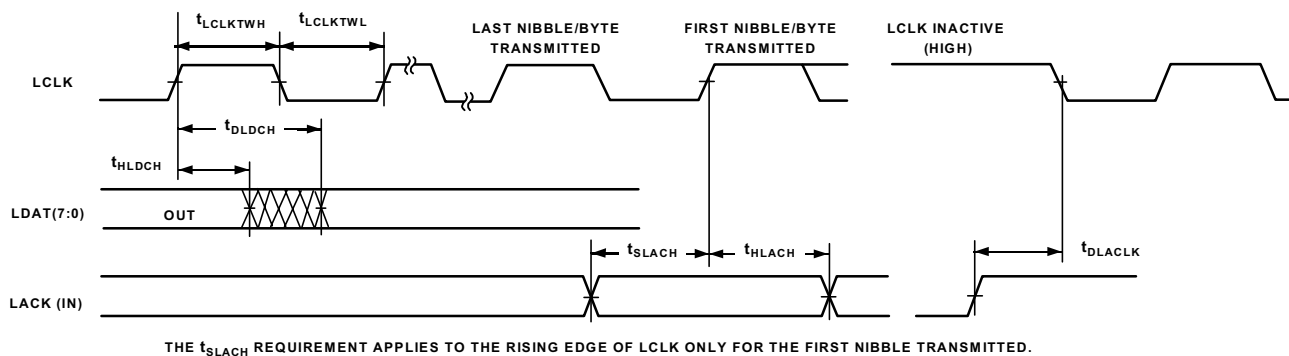

Figure 25. Link Ports—Transmit

Serial Ports

To determine whether communication is possible between two devices at clock speed n, the following specifications must be confirmed: 1) frame sync delay and frame sync setup and hold, 2) data delay and data setup and hold, and 3) SCLK width.

Table 21. Serial Ports—External Clock

Parameter	Min	Max	Unit
<i>Timing Requirements:</i>			
t _{SFSE}	TFS/RFS Setup Before TCLK/RCLK ¹		ns
t _{HFSE}	TFS/RFS Hold After TCLK/RCLK ^{1,2}		ns
t _{SDRE}	Receive Data Setup Before RCLK ¹		ns
t _{HDRE}	Receive Data Hold After RCLK ¹		ns
t _{SCLKW}	TCLK/RCLK Width		ns
t _{SCLK}	TCLK/RCLK Period		ns

¹Referenced to sample edge.

²RFS hold after RCK when MCE = 1, MFD = 0 is 0 ns minimum from drive edge. TFS hold after TCK for late external TFS is 0 ns minimum from drive edge.

Table 22. Serial Ports—Internal Clock

Parameter	Min	Max	Unit
<i>Timing Requirements:</i>			
t _{SFSI}	TFS Setup Before TCLK ¹ ; RFS Setup Before RCLK ¹		ns
t _{HFSI}	TFS/RFS Hold After TCLK/RCLK ^{1,2}		ns
t _{SDRI}	Receive Data Setup Before RCLK ¹		ns
t _{HDRI}	Receive Data Hold After RCLK ¹		ns

¹Referenced to sample edge.

²RFS hold after RCK when MCE = 1, MFD = 0 is 0 ns minimum from drive edge. TFS hold after TCK for late external TFS is 0 ns minimum from drive edge.

Table 23. Serial Ports—External or Internal Clock

Parameter	Min	Max	Unit
<i>Switching Characteristics:</i>			
t _{DFSE}	RFS Delay After RCLK (Internally Generated RFS) ¹		ns
t _{HOESE}	RFS Hold After RCLK (Internally Generated RFS) ¹		ns

¹Referenced to drive edge.

Table 24. Serial Ports—External Clock

Parameter	Min	Max	Unit
<i>Switching Characteristics:</i>			
t _{DFSE}	TFS Delay After TCLK (Internally Generated TFS) ¹		ns
t _{HOESE}	TFS Hold After TCLK (Internally Generated TFS) ¹		ns
t _{DDTE}	Transmit Data Delay After TCLK ¹		ns
t _{HDTE}	Transmit Data Hold After TCLK ¹		ns

¹Referenced to drive edge.

Table 25. Serial Ports—Internal Clock

Parameter	Min	Max	Unit
<i>Switching Characteristics:</i>			
t _{DFSI}	TFS Delay After TCLK (Internally Generated TFS) ¹		ns
t _{HOFISI}	TFS Hold After TCLK (Internally Generated TFS) ¹		ns

ADSP-21160M

Table 25. Serial Ports—Internal Clock (Continued)

Parameter		Min	Max	Unit
t _{DDTI}	Transmit Data Delay After TCLK ¹		7.5	ns
t _{HDTI}	Transmit Data Hold After TCLK ¹	0		ns
t _{SCLKIW}	TCLK/RCLK Width	0.5t _{SCLK} - 2.5	0.5t _{SCLK} + 2	ns

¹Referenced to drive edge.

Table 26. Serial Ports—Enable and Three-State

Parameter		Min	Max	Unit
<i>Switching Characteristics:</i>				
t _{DDTEN}	Data Enable from External TCLK ¹	4		ns
t _{DDTTE}	Data Disable from External TCLK ¹		10	ns
t _{DDTIN}	Data Enable from Internal TCLK ¹	0		ns
t _{DDTTI}	Data Disable from Internal TCLK ¹		3	ns

¹Referenced to drive edge.

DATA RECEIVE— INTERNAL CLOCK

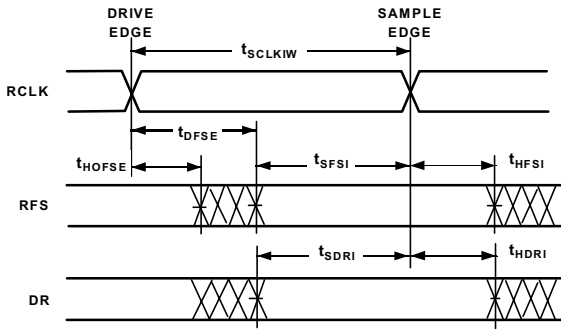

DATA RECEIVE— EXTERNAL CLOCK

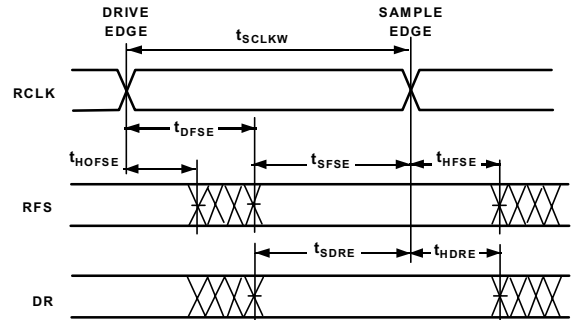

NOTE: EITHER THE RISING EDGE OR FALLING EDGE OF RCLK, TCLK CAN BE USED AS THE ACTIVE SAMPLING EDGE.

DATA TRANSMIT— INTERNAL CLOCK

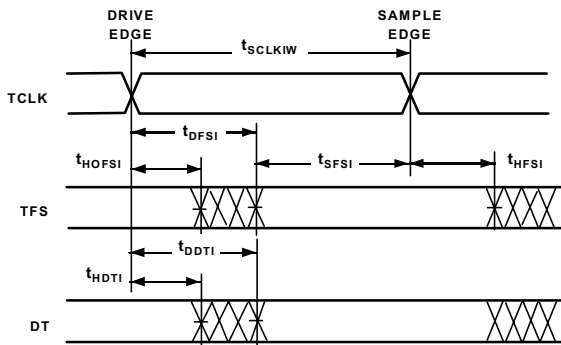

DATA TRANSMIT— EXTERNAL CLOCK

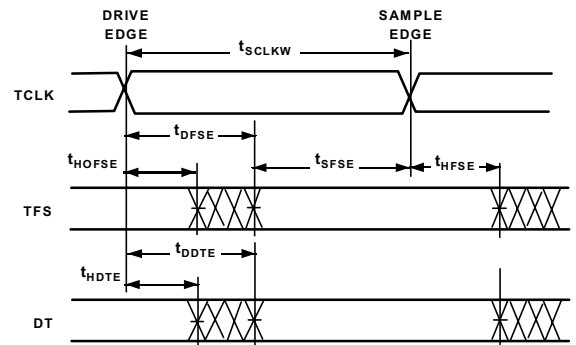

NOTE: EITHER THE RISING EDGE OR FALLING EDGE OF RCLK, TCLK CAN BE USED AS THE ACTIVE SAMPLING EDGE.

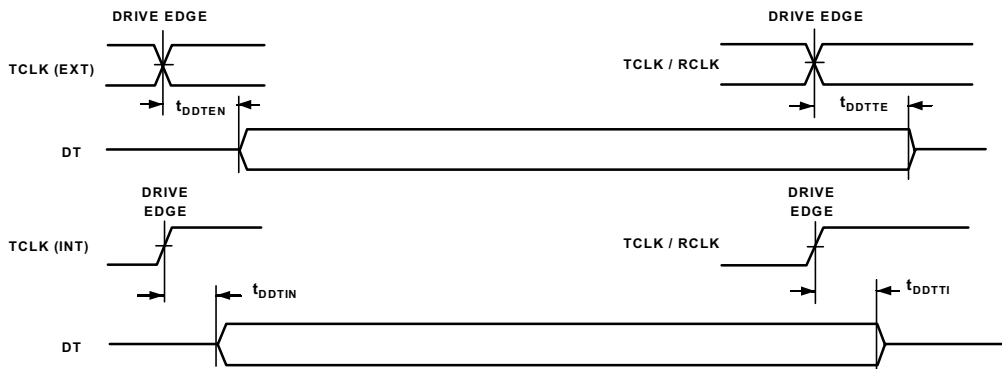

Figure 26. Serial Ports

ADSP-21160M

Table 27. Serial Ports—External Late Frame Sync

Parameter	Min	Max	Unit
<i>Switching Characteristics:</i>			
$t_{DDTLFSE}$ Data Delay from Late External TFS or External RFS with MCE = 1, MFD = 0 ¹		13	ns
$t_{DDTENFS}$ Data Enable from late FS or MCE = 1, MFD = 0 ¹	1.0		ns

¹MCE = 1, TFS enable and TFS valid follow $t_{DDTLFSE}$ and $t_{DDTENFS}$.

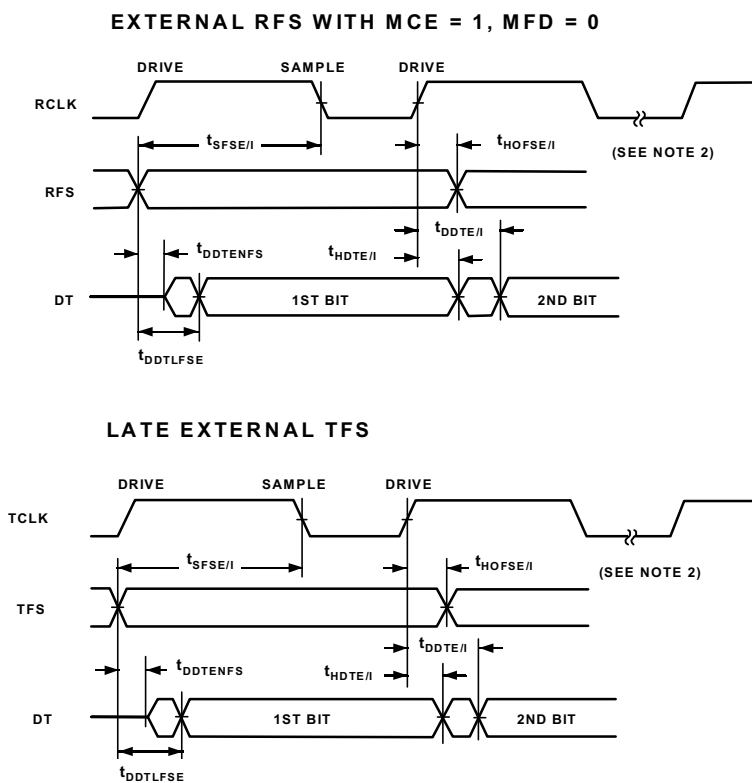

Figure 27. External Late Frame Sync

JTAG Test Access Port and Emulation

Table 28. JTAG Test Access Port and Emulation

Parameter	Min	Max	Unit
<i>Timing Requirements:</i>			
t_{TCK} TCK Period	t_{CK}		ns
t_{STAP} TDI, TMS Setup Before TCK High	5		ns
t_{HTAP} TDI, TMS Hold After TCK High	6		ns
t_{SSYS} System Inputs Setup Before TCK Low ¹	7		ns
t_{HSYS} System Inputs Hold After TCK Low ¹	18		ns
t_{TRSTW} \overline{TRST} Pulsewidth	$4t_{CK}$		ns
<i>Switching Characteristics:</i>			
t_{DTDO} TDO Delay from TCK Low		13	ns
t_{DSYS} System Outputs Delay After TCK Low ²		30	ns

¹System Inputs = DATA63-0, ADDR31-0, \overline{RDx} , \overline{WRx} , ACK, \overline{SBTS} , HBR, HBG, CS, DMAR1, DMAR2, BR6-1, ID2-0, RPBA, IRQ2-0, FLAG3-0, PA, BRST, DR0, DR1, TCLK0, TCLK1, RCLK0, RCLK1, TFS0, TFS1, RFS0, RFS1, LxDAT7-0, LxCLK, LxACK, EBOOT, LBOOT, BMS, CLKIN, RESET.

²System Outputs = DATA63-0, ADDR31-0, $\overline{MS3-0}$, \overline{RDx} , \overline{WRx} , ACK, PAGE, CLKOUT, HBG, REDY, DMAG1, DMAG2, BR6-1, PA, BRST, CIF, FLAG3-0, TIMEXP, DT0, DT1, TCLK0, TCLK1, RCLK0, RCLK1, TFS0, TFS1, RFS0, RFS1, LxDAT7-0, LxCLK, LxACK, BMS.

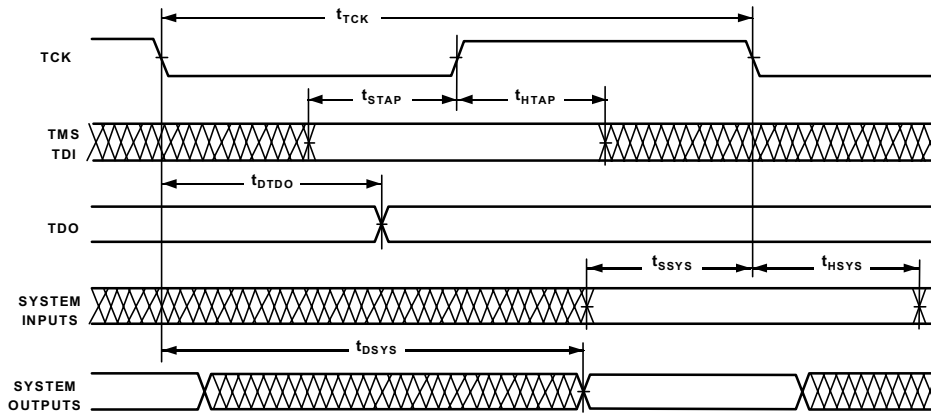

Figure 28. IEEE 11499.1 JTAG Test Access Port

ADSP-21160M

Output Drive Currents

Figure 29 shows typical I-V characteristics for the output drivers of the ADSP-21160M. The curves represent the current drive capability of the output drivers as a function of output voltage.

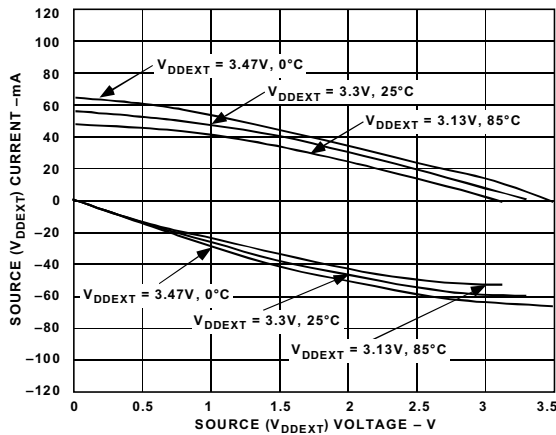

Figure 29. ADSP-21160M Typical Drive Currents

Power Dissipation

Total power dissipation has two components, one due to internal circuitry and one due to the switching of external output drivers.

Internal power dissipation is dependent on the instruction execution sequence and the data operands involved. Using the current specifications ($I_{DDINPEAK}$, $I_{DDINHIGH}$, $I_{DDINLOW}$, I_{DDIDLE}) from [Electrical Characteristics on page 13](#) and the current-versus-operation information in [Table 29](#), engineers can estimate the ADSP-21160M's internal power supply (V_{DDINT}) input current for a specific application, according to the following formula:

$$\begin{aligned} & \% \text{ Peak} \times I_{DDINPEAK} \\ & \% \text{ High} \times I_{DDINHIGH} \\ & \% \text{ Low} \times I_{DDINLOW} \\ & + \% \text{ Idle} \times I_{DDIDLE} \\ & \hline & I_{DDINT} \end{aligned}$$

The external component of total power dissipation is caused by the switching of output pins. Its magnitude depends on:

- the number of output pins that switch during each cycle (O)
- the maximum frequency at which they can switch (f)
- their load capacitance (C)
- their voltage swing (VDD)

and is calculated by:

$$P_{EXT} = O \times C \times V_{DD}^2 \times f$$

The load capacitance should include the processor's package capacitance (C_{IN}). The switching frequency includes driving the load high and then back low. Address and data pins can drive high and low at a maximum rate of

$1/(2t_{CK})$. The write strobe can switch every cycle at a frequency of $1/t_{CK}$. Select pins switch at $1/(2t_{CK})$, but selects can switch on each cycle.

Table 29. ADSP-21160M Operation Types vs. Input Current

Operation	Peak Activity ¹	High Activity ¹	Low Activity ¹
Instruction Type	Multifunction	Multifunction	Single Function
Instruction Fetch	Cache	Internal Memory	Internal Memory
Core Memory Access ²	2 per t_{CK} cycle (DM×64 and PM×64)	1 per t_{CK} cycle (DM×64)	None
Internal Memory DMA	1 per 2 t_{CCLK} cycles	1 per 2 t_{CCLK} cycles	None
External Memory DMA	1 per external port cycle (×64)	1 per external port cycle (×64)	None
Data bit pattern for core memory access and DMA	Worst case	Random	N/A

¹Peak Activity= $I_{DDINPEAK}$, High Activity= $I_{DDINHIG}$, and Low Activity= $I_{DDINLOW}$. The state of the PEYEN bit (SIMD versus SISD mode) does not influence these calculations.

²These assume a 2:1 core clock ratio. For more information on ratios and clocks (t_{CK} and t_{CCLK}), see the timing ratio definitions on page 15.

ADSP-21160M

Example: Estimate P_{EXT} with the following assumptions:

- A system with one bank of external data memory—asynchronous RAM (64-bit)
- Four 64K × 16 RAM chips are used, each with a load of 10 pF

- External data memory writes occur every other cycle, a rate of $1/(4 t_{CK})$, with 50% of the pins switching
- The bus cycle time is 40 MHz ($t_{CK} = 25$ ns).

The P_{EXT} equation is calculated for each class of pins that can drive:

Table 30. External Power Calculations (3.3 V Device)

Pin Type	# of Pins	% Switching	× C	× f	× VDD ²	= P _{EXT}
Address	15	50	× 44.7 pF	× 12.5 MHz	× 10.9 V	= 0.046 W
MS0	1	0	× 44.7 pF	× 12.5 MHz	× 10.9 V	= 0.000 W
\overline{WRx}	2	—	× 44.7 pF	× 25 MHz	× 10.9 V	= 0.024 W
Data	64	50	× 14.7 pF	× 12.5 MHz	× 10.9 V	= 0.064 W
CLKOUT	1	—	× 4.7 pF	× 25 MHz	× 10.9 V	= 0.001 W
						P _{EXT} = 0.135 W

A typical power consumption can now be calculated for these conditions by adding a typical internal power dissipation:

$$P_{TOTAL} = P_{EXT} + P_{INT} + P_{PLL}$$

Where:

- P_{EXT} is from [Table 30](#)
- P_{INT} is $I_{DDINT} \times 2.5V$, using the calculation I_{DDINT} listed in [Power Dissipation on page 42](#)
- P_{PLL} is $AI_{DD} \times 2.5V$, using the value for AI_{DD} listed in [ABSOLUTE MAXIMUM RATINGS on page 14](#)

Note that the conditions causing a worst-case P_{EXT} are different from those causing a worst-case P_{INT} . Maximum P_{INT} cannot occur while 100% of the output pins are switching from all ones to all zeros. Note also that it is not common for an application to have 100% or even 50% of the outputs switching simultaneously.

Test Conditions

The test conditions for timing parameters appearing in [ADSP-21160M specifications on page 13](#) include output disable time, output enable time, and capacitive loading.

Output Disable Time

Output pins are considered to be disabled when they stop driving, go into a high impedance state, and start to decay from their output high or low voltage. The time for the voltage on the bus to decay by $-V$ is dependent on the capacitive load, C_L and the load current, I_L . This decay time can be approximated by the following equation:

$$t_{DECAY} = (C_L \Delta V) / I_L$$

The output disable time t_{DIS} is the difference between $t_{MEASURED}$ and t_{DECAY} as shown in [Figure 30](#). The time $t_{MEASURED}$ is the interval from when the reference signal switches to when the output voltage decays $-V$ from the measured output high or output low voltage. t_{DECAY} is calculated with test loads C_L and I_L , and with $-V$ equal to 0.5 V.

Output Enable Time

Output pins are considered to be enabled when they have made a transition from a high impedance state to when they start driving. The output enable time t_{ENA} is the interval from when a reference signal reaches a high or low voltage level to when the output has reached a specified high or low trip point, as shown in the Output Enable/Disable diagram ([Figure 30](#)). If multiple pins (such as the data bus) are enabled, the measurement value is that of the first pin to start driving.

Example System Hold Time Calculation

To determine the data output hold time in a particular system, first calculate t_{DECAY} using the equation given above. Choose $-V$ to be the difference between the ADSP-21160M's output voltage and the input threshold for the device requiring the hold time. A typical $-V$ will be 0.4 V. C_L is the total bus capacitance (per data line), and I_L is the total leakage or three-state current (per data line). The hold time will be t_{DECAY} plus the minimum disable time (i.e., t_{DATRWH} for the write cycle).

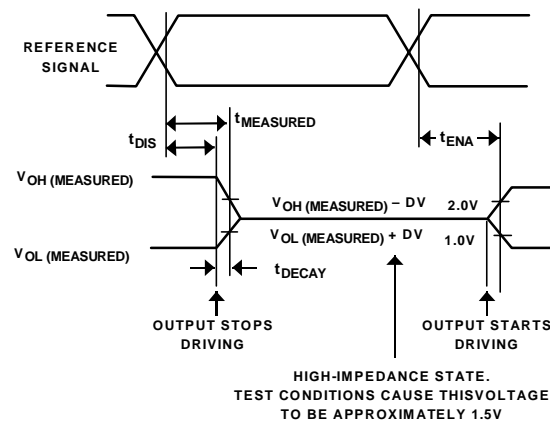

Figure 30. Output Enable/Disable

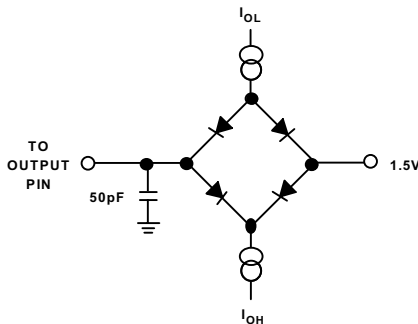

Figure 31. Equivalent Device Loading for AC Measurements (Includes All Fixtures)



Figure 32. Voltage Reference Levels for AC Measurements (Except Output Enable/Disable)

Capacitive Loading

Output delays and holds are based on standard capacitive loads: 50 pF on all pins (see Figure 31). The delay and hold specifications given should be derated by a factor of 1.5 ns/50 pF for loads other than the nominal value of 50 pF. Figure 33 and Figure 34 show how output rise time varies with capacitance. Figure 35 graphically shows how output delays and holds vary with load capacitance. (Note that this graph or derating does not apply to output disable delays; see Output Disable Time on page 44.) The graphs of Figure 33, Figure 34, and Figure 35 may not be linear outside the ranges shown.

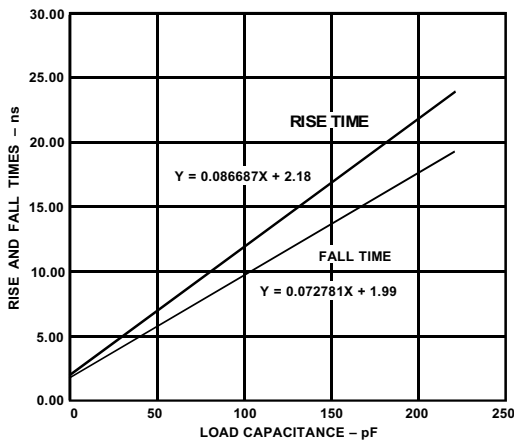

Figure 33. Typical Output Rise Time (10%-90%, $V_{DDEXT} = Max$) vs. Load Capacitance

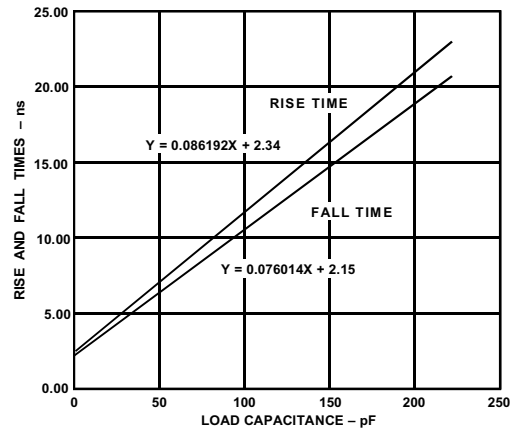

Figure 34. Typical Output Rise Time (10%-90%, $V_{DDEXT} = Min$) vs. Load Capacitance

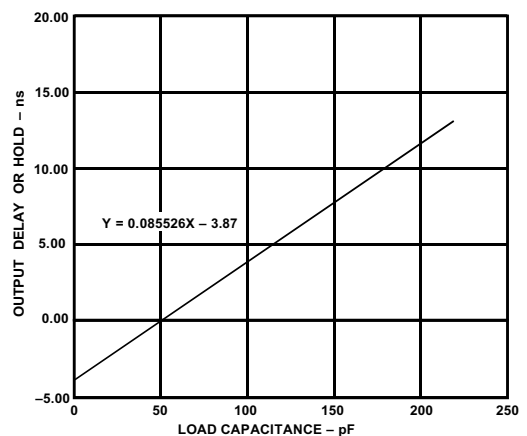

Figure 35. Typical Output Delay or Hold vs. Load Capacitance (at Max Case Temperature)

Environmental Conditions

The ADSP-21160M is tested for performance over the commercial temperature range, 0°C to 85°C.

Thermal Characteristics

The ADSP-21160M is packaged in a 400-ball Plastic Ball Grid Array (PBGA). The ADSP-21160M is specified for a case temperature (T_{CASE}). To ensure that the T_{CASE} data sheet specification is not exceeded, a heatsink and/or an air flow source may be used. Use the center block of ground pins (PBGA balls: H8-13, J8-13, K8-13, L8-13, M8-13, and N8-13) to provide thermal pathways to the printed circuit board's ground plane. A heatsink should be attached to the ground plane (as close as possible to the thermal pathways) with a thermal adhesive.

ADSP-21160M

$$T_{CASE} = T_{AMB} + (PD \times \theta_{CA})$$

- T_{CASE} = Case temperature (measured on top surface of package)
- PD = Power dissipation in W (this value depends upon the specific application; a method for calculating PD is shown under Power Dissipation).
- θ_{CA} = Value from [Table 31](#).
- θ_{JB} = 6.46°C/W

Table 31. Airflow Over Package Versus θ_{CA}

Airflow (Linear Ft./Min.)	0	200	400
θ_{CA} (°C/W) ¹	12.13	9.86	8.7

¹ θ_{JC} = 3.6 °C/W.

400-BALL METRIC PBGA PIN CONFIGURATIONS

[Table 32](#) lists the pin assignments for the PBGA package, and the pin configurations diagram [on page 51](#) shows the pin assignment summary.

Table 32. 400-ball Metric PBGA Pin Assignments

Pin Name	PBGA Pin#	Pin Name	PBGA Pin#	Pin Name	PBGA Pin#	Pin Name	PBGA Pin#
DATA[14]	A01	DATA[22]	B01	DATA[24]	C01	DATA[28]	D01
DATA[13]	A02	DATA[16]	B02	DATA[18]	C02	DATA[25]	D02
DATA[10]	A03	DATA[15]	B03	DATA[17]	C03	DATA[20]	D03
DATA[8]	A04	DATA[9]	B04	DATA[11]	C04	DATA[19]	D04
DATA[4]	A05	DATA[6]	B05	DATA[7]	C05	DATA[12]	D05
DATA[2]	A06	DATA[3]	B06	DATA[5]	C06	V _{DDEXT}	D06
TDI	A07	DATA[0]	B07	DATA[1]	C07	V _{DDINT}	D07
$\overline{\text{TRST}}$	A08	TCK	B08	TMS	C08	V _{DDEXT}	D08
$\overline{\text{RESET}}$	A09	$\overline{\text{EMU}}$	B09	TD0	C09	V _{DDEXT}	D09
RPBA	A10	$\overline{\text{IRQ2}}$	B10	$\overline{\text{IRQ1}}$	C10	V _{DDEXT}	D10
$\overline{\text{IRQ0}}$	A11	FLAG3	B11	FLAG2	C11	V _{DDEXT}	D11
FLAG1	A12	FLAG0	B12	V _{DDEXT}	C12	V _{DDEXT}	D12
TIMEXP	A13	V _{DDEXT}	B13	NC	C13	V _{DDINT}	D13
V _{DDEXT}	A14	NC	B14	TCLK1	C14	V _{DDEXT}	D14
NC	A15	DT1	B15	DR1	C15	TFS0	D15
TFS1	A16	RCLK1	B16	DR0	C16	L1DAT[7]	D16
RFS1	A17	RFS0	B17	L0DAT[7]	C17	L0CLK	D17
RCLK0	A18	TCLK0	B18	L0DAT[6]	C18	L0DAT[3]	D18
DT0	A19	L0DAT[5]	B19	L0ACK	C19	L0DAT[1]	D19
L0DAT[4]	A20	L0DAT[2]	B20	L0DAT[0]	C20	L1CLK	D20
DATA[30]	E01	DATA[34]	F01	DATA[38]	G01	DATA[40]	H01
DATA[29]	E02	DATA[33]	F02	DATA[35]	G02	DATA[39]	H02
DATA[23]	E03	DATA[27]	F03	DATA[32]	G03	DATA[37]	H03
DATA[21]	E04	DATA[26]	F04	DATA[31]	G04	DATA[36]	H04
V _{DDEXT}	E05	V _{DDEXT}	F05	V _{DDEXT}	G05	V _{DDEXT}	H05
V _{DDINT}	E06	V _{DDINT}	F06	V _{DDINT}	G06	V _{DDINT}	H06
V _{DDINT}	E07	GND	F07	GND	G07	GND	H07
V _{DDINT}	E08	GND	F08	GND	G08	GND	H08
V _{DDINT}	E09	GND	F09	GND	G09	GND	H09
V _{DDINT}	E10	GND	F10	GND	G10	GND	H10
GND	E11	GND	F11	GND	G11	GND	H11
V _{DDINT}	E12	GND	F12	GND	G12	GND	H12
V _{DDINT}	E13	GND	F13	GND	G13	GND	H13
V _{DDINT}	E14	GND	F14	GND	G14	GND	H14
V _{DDINT}	E15	V _{DDINT}	F15	V _{DDINT}	G15	V _{DDINT}	H15
V _{DDEXT}	E16	V _{DDEXT}	F16	V _{DDEXT}	G16	V _{DDEXT}	H16
L1DAT[6]	E17	L1DAT[4]	F17	L1DAT[2]	G17	L2DAT[5]	H17
L1DAT[5]	E18	L1DAT[3]	F18	L2DAT[6]	G18	L2ACK	H18
L1ACK	E19	L1DAT[0]	F19	L2DAT[4]	G19	L2DAT[3]	H19
L1DAT[1]	E20	L2DAT[7]	F20	L2CLK	G20	L2DAT[1]	H20

ADSP-21160M

Table 32. 400-ball Metric PBGA Pin Assignments (Continued)

Pin Name	PBGA Pin#	Pin Name	PBGA Pin#	Pin Name	PBGA Pin#	Pin Name	PBGA Pin#
DATA[44]	J01	CLK_CFG_0	K01	CLKIN	L01	AV _{DD}	M01
DATA[43]	J02	DATA[46]	K02	CLK_CFG_1	L02	CLK_CFG_3	M02
DATA[42]	J03	DATA[45]	K03	AGND	L03	CLKOUT	M03
DATA[41]	J04	DATA[47]	K04	CLK_CFG_2	L04	GND	M04
V _{DDEXT}	J05	V _{DDEXT}	K05	V _{DDEXT}	L05	V _{DDEXT}	M05
V _{DDINT}	J06	V _{DDINT}	K06	V _{DDINT}	L06	V _{DDINT}	M06
GND	J07	GND	K07	GND	L07	GND	M07
GND	J08	GND	K08	GND	L08	GND	M08
GND	J09	GND	K09	GND	L09	GND	M09
GND	J10	GND	K10	GND	L10	GND	M10
GND	J11	GND	K11	GND	L11	GND	M11
GND	J12	GND	K12	GND	L12	GND	M12
GND	J13	GND	K13	GND	L13	GND	M13
GND	J14	GND	K14	GND	L14	GND	M14
V _{DDINT}	J15	V _{DDINT}	K15	V _{DDINT}	L15	V _{DDINT}	M15
V _{DDEXT}	J16	V _{DDEXT}	K16	V _{DDEXT}	L16	V _{DDEXT}	M16
L2DAT[2]	J17	BR6	K17	BR2	L17	PAGE	M17
L2DAT[0]	J18	BR5	K18	BR1	L18	SBTS	M18
HBG	J19	BR4	K19	ACK	L19	PA	M19
HBR	J20	BR3	K20	REDY	L20	L3DAT[7]	M20
NC	N01	DATA[49]	P01	DATA[53]	R01	DATA[56]	T01
NC	N02	DATA[50]	P02	DATA[54]	R02	DATA[58]	T02
DATA[48]	N03	DATA[52]	P03	DATA[57]	R03	DATA[59]	T03
DATA[51]	N04	DATA[55]	P04	DATA[60]	R04	DATA[63]	T04
V _{DDEXT}	N05	V _{DDEXT}	P05	V _{DDEXT}	R05	V _{DDEXT}	T05
V _{DDINT}	N06	V _{DDINT}	P06	V _{DDINT}	R06	V _{DDINT}	T06
GND	N07	GND	P07	GND	R07	V _{DDINT}	T07
GND	N08	GND	P08	GND	R08	V _{DDINT}	T08
GND	N09	GND	P09	GND	R09	V _{DDINT}	T09
GND	N10	GND	P10	GND	R10	V _{DDINT}	T10
GND	N11	GND	P11	GND	R11	V _{DDINT}	T11
GND	N12	GND	P12	GND	R12	V _{DDINT}	T12
GND	N13	GND	P13	GND	R13	V _{DDINT}	T13
GND	N14	GND	P14	GND	R14	V _{DDINT}	T14
V _{DDINT}	N15	V _{DDINT}	P15	GND	R15	V _{DDINT}	T15
V _{DDEXT}	N16	V _{DDEXT}	P16	V _{DDEXT}	R16	V _{DDEXT}	T16
L3DAT[5]	N17	L3DAT[2]	P17	L4DAT[5]	R17	L4DAT[3]	T17
L3DAT[6]	N18	L3DAT[1]	P18	L4DAT[6]	R18	L4ACK	T18
L3DAT[4]	N19	L3DAT[3]	P19	L4DAT[7]	R19	L4CLK	T19
L3CLK	N20	L3ACK	P20	L3DAT[0]	R20	L4DAT[4]	T20

Table 32. 400-ball Metric PBGA Pin Assignments (Continued)

Pin Name	PBGA Pin#	Pin Name	PBGA Pin#	Pin Name	PBGA Pin#	Pin Name	PBGA Pin#
DATA[61]	U01	ADDR[4]	V01	ADDR[5]	W01	ADDR[8]	Y01
DATA[62]	U02	ADDR[6]	V02	ADDR[9]	W02	ADDR[11]	Y02
ADDR[3]	U03	ADDR[7]	V03	ADDR[12]	W03	ADDR[13]	Y03
ADDR[2]	U04	ADDR[10]	V04	ADDR[15]	W04	ADDR[16]	Y04
V _{DDEXT}	U05	ADDR[14]	V05	ADDR[17]	W05	ADDR[19]	Y05
V _{DDEXT}	U06	ADDR[18]	V06	ADDR[20]	W06	ADDR[21]	Y06
V _{DDEXT}	U07	ADDR[22]	V07	ADDR[23]	W07	ADDR[24]	Y07
V _{DDEXT}	U08	ADDR[25]	V08	ADDR[26]	W08	ADDR[27]	Y08
V _{DDEXT}	U09	ADDR[28]	V09	ADDR[29]	W09	ADDR[30]	Y09
V _{DDEXT}	U10	ID0	V10	ID1	W10	ADDR[31]	Y10
V _{DDEXT}	U11	ADDR[1]	V11	ADDR[0]	W11	ID2	Y11
V _{DDEXT}	U12	$\overline{MS1}$	V12	\overline{BMS}	W12	\overline{BRST}	Y12
V _{DDEXT}	U13	\overline{CS}	V13	$\overline{MS2}$	W13	$\overline{MS0}$	Y13
V _{DDEXT}	U14	$\overline{RD\overline{L}}$	V14	\overline{CIF}	W14	$\overline{MS3}$	Y14
V _{DDEXT}	U15	$\overline{DMAR2}$	V15	\overline{RDH}	W15	\overline{WRH}	Y15
V _{DDEXT}	U16	L5DAT[0]	V16	$\overline{DMAG2}$	W16	\overline{WRL}	Y16
L5DAT[7]	U17	L5DAT[2]	V17	LBOOT	W17	$\overline{DMAG1}$	Y17
L4DAT[0]	U18	L5ACK	V18	L5DAT[1]	W18	$\overline{DMAR1}$	Y18
L4DAT[1]	U19	L5DAT[4]	V19	L5DAT[3]	W19	EBOOT	Y19
L4DAT[2]	U20	L5DAT[6]	V20	L5DAT[5]	W20	L5CLK	Y20

ADSP-21160M

400-BALL METRIC PBGA PIN CONFIGURATIONS (BOTTOM VIEW, SUMMARY)

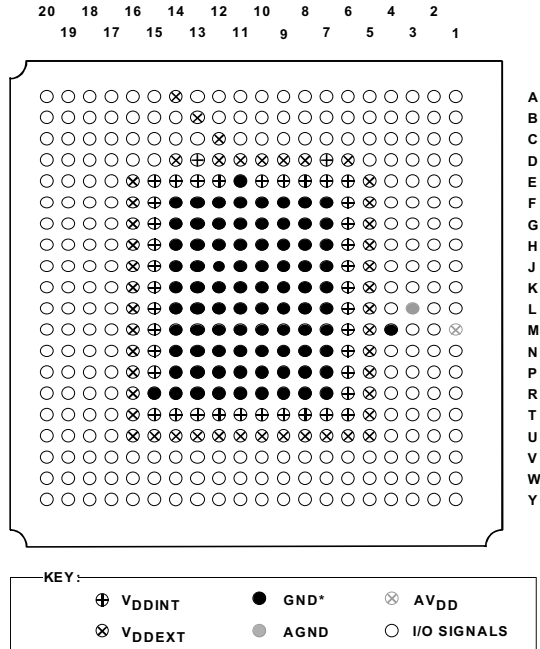

* USE THE CENTER BLOCK OF GROUND PINS (PBGA BALLS: H8-13, J8-13, K8-13, L8-13, M8-13, AND N8-13) TO PROVIDE THERMAL PATHWAYS TO YOUR PRINTED CIRCUIT BOARD'S GROUND PLANE.

OUTLINE DIMENSIONS

The ADSP-21160M comes in a 27mm × 27mm, 400-ball Metric PBGA package with 20 rows of balls.

400-BALL METRIC PBGA (B-400)

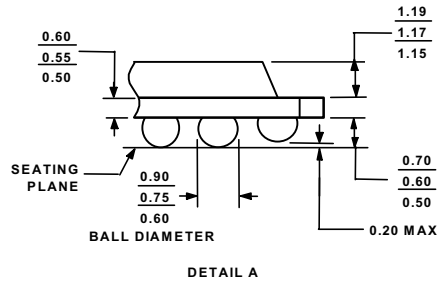
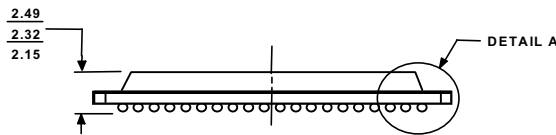
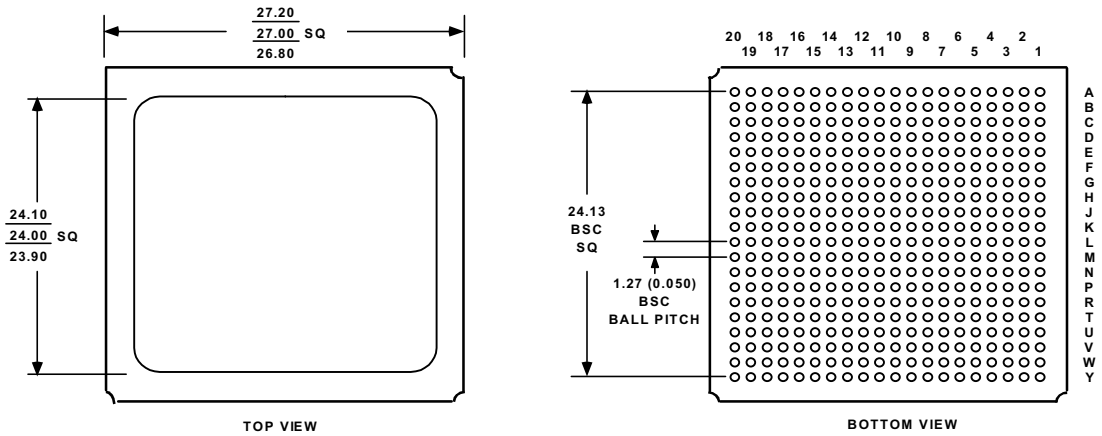

- NOTES:
1. ALL DIMENSIONS ARE IN MILLIMETERS, EXCEPT (0.050) DIMENSION AT BALL PITCH IS IN INCHES.
 2. CENTER FIGURES ARE NOMINAL DIMENSIONS.
 3. THE ACTUAL POSITION OF THE BALL GRID IS WITHIN 0.30 OF ITS IDEAL POSITION RELATIVE TO THE PACKAGE EDGES.
 4. THE ACTUAL POSITION OF EACH BALL IS WITHIN 0.10 OF ITS IDEAL POSITION RELATIVE TO THE BALL GRID.

ADSP-21160M

ORDERING GUIDE

Part Number^{1, 2}	Case Temperature Range	Instruction Rate	On-Chip SRAM	Operating Voltage
ADSP-21160MKB-80	0°C to 85°C	80 MHz	4 Mbit	2.5 INT/3.3 EXT V

¹B = Plastic Ball Grid Array (PBGA) package.

²See ADSP-21160N data sheet for ordering information for higher-performance derivative.

This datasheet has been download from:

www.datasheetcatalog.com

Datasheets for electronics components.