



Isolated DC/DC Converter

Preliminary Technical Data

ADuM5000

FEATURES

- isoPower*[™] integrated isolated DC/DC converter
- Regulated 3.3V or 5V output
- 500mW output power
- SOIC 16-lead package with > 8mm creepage
- High temperature operation: 105°C
- High common-mode transient immunity: > 25 kV/μs
- Thermal Overload Protection
- Safety and regulatory approvals (pending)
 - UL recognition
 - 2500 V rms for 1 minute per UL 1577
 - CSA component acceptance notice #5A
 - VDE certificate of conformity
 - DIN V VDE V 0884-10 (VDE V 0884-10):2006-12
 - $V_{IORM} = 560$ V peak

APPLICATIONS

- RS-232/RS-422/RS-485 transceiver
- Industrial field bus isolation
- Power Supply start up and Gate Drive
- Isolated Sensor Interface
- Industrial PLC

GENERAL DESCRIPTION

The ADuM5000¹ is an isolated DC/DC converter. Based on Analog Devices' *iCoupler*[®] technology, the DC/DC converter provides up to 500 mW of regulated, isolated power at either 5.0V from a 5.0V input supply or 3.3V from a 3.3V or 5.0V supply. Analog Devices' chip-scale transformer *iCoupler* technology is used both for the DC/DC converter. The result is a small form-factor total-isolation solution.

ADuM5000 units may be used in combination with ADuM540x and ADuM520x with *isoPower* to achieve higher output power levels.

FUNCTIONAL BLOCK DIAGRAM

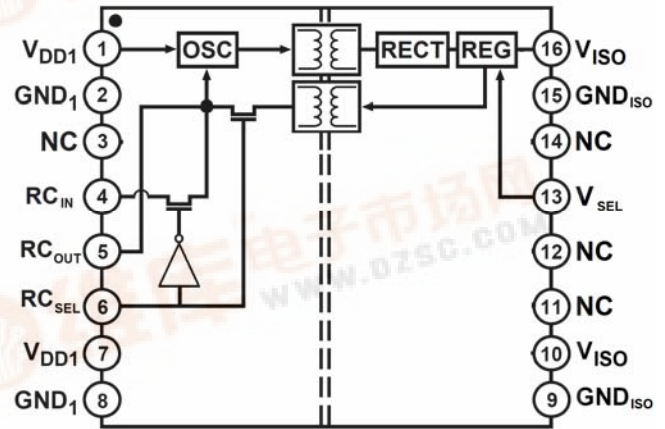

Figure 1 ADuM5000 Functional Diagram

¹ Protected by U.S. Patents 5,952,849, 6,873,065, and 7,075,329 B2, Other patents pending.



TABLE OF CONTENTS

Applications.....	1	Absolute Maximum Ratings	8
Revision History	2	ESD Caution.....	8
Specifications.....	3	Pin Configuration and Function Descriptions.....	9
Electrical Characteristics – 5V Primary Input Supply / 5V Secondary Isolated Supply	3	Application Information.....	12
Electrical Characteristics – 3.3V Primary Input Supply / 3.3V Secondary Isolated Supply	4	Theory of operation	12
Electrical Characteristics – 5V Primary Input Supply / 3.3V Secondary Isolated Supply	5	PC Board Layout	12
Package Characteristics	6	Thermal Analysis	12
Insulation and Safety-Related Specifications	6	Insulation Lifetime	13
DIN V VDE V 0884-10 (VDE V 0884-10) Insulation Characteristics	7	Outline Dimensions	15
Recommended Operating Conditions	7	Ordering Guide	15

REVISION HISTORY

SPECIFICATIONS

ELECTRICAL CHARACTERISTICS – 5V PRIMARY INPUT SUPPLY / 5V SECONDARY ISOLATED SUPPLY¹

4.5 V \leq V_{DD1} \leq 5.5 V, V_{SEL}=V_{ISO}; all voltages are relative to their respective ground. All min/max specifications apply over the entire recommended operating range, unless otherwise noted. All typical specifications are at T_A = 25°C, V_{DD} = 5.0 V, V_{ISO} = 5.0 V, V_{SEL}= V_{ISO}.

Table 1.

Parameter	Symbol	Min	Typ	Max	Unit	Test Conditions
Setpoint	V _{ISO}	4.7	5.0	5.4	V	I _{ISO} =0mA
Line Regulation	V _{ISO(LINE)}		1		mV/V	I _{ISO} =50mA, V _{DD1} =4.5V to 5.5V
Load Regulation	V _{ISO(LOAD)}		1	5	%	I _{ISO} = 10mA to 100mA
Output Ripple	V _{ISO(RIP)}		75		mV _{P-P}	5MHz Bandwidth, C _{BO} =0.1μF 6.6μF, I _{ISO} = 100mA
Output Noise	V _{ISO(N)}		200		mV _{P-P}	20MHz Bandwidth, C _{BO} =0.1μF 6.6μF, I _{ISO} = 100mA
Switching Frequency	f _{OSC}		180		MHz	
PWM Frequency	f _{PWM}		625		kHz	
I _{DD1} Supply Current, Full V _{ISO} load ²	I _{DD1(MAX)}		290		mA	I _{ISO} =100mA

¹ All voltages are relative to their respective ground.

² I_{DD1(MAX)} is the input current under full dynamic and V_{ISO} load conditions.

ELECTRICAL CHARACTERISTICS – 3.3V PRIMARY INPUT SUPPLY / 3.3V SECONDARY ISOLATED SUPPLY¹

$3.0\text{ V} \leq V_{DD1} \leq 3.6\text{ V}$, $V_{SEL}=\text{GND}_{ISO}$; all voltages are relative to their respective ground. All min/max specifications apply over the entire recommended operating range, unless otherwise noted. All typical specifications are at $T_A = 25^\circ\text{C}$, $V_{DD} = 3.3\text{ V}$, $V_{ISO} = 3.3\text{ V}$, $V_{SEL}=\text{GND}_{ISO}$.

Table 2.

Parameter	Symbol	Min	Typ	Max	Unit	Test Conditions
Setpoint	V_{ISO}	3.0	3.3	3.6	V	$I_{ISO}=0\text{mA}$
Line Regulation	$V_{ISO(LINE)}$		1		mV/V	$I_{ISO}=37.5\text{ mA}$, $V_{DD1}=3.0\text{V to }3.6\text{V}$
Load Regulation	$V_{ISO(LOAD)}$		1	5	%	$I_{ISO} = 6\text{mA to }54\text{mA}$
Output Ripple	$V_{ISO(RIP)}$		50		mV _{P-P}	20MHz Bandwidth, $C_{BO}=0.1\mu\text{F} \parallel 10\mu\text{F}$, $I_{ISO} = 90\text{mA}$
Output Noise	$V_{ISO(N)}$		130		mV _{P-P}	20MHz Bandwidth, $C_{BO}=0.1\mu\text{F} \parallel 10\mu\text{F}$, $I_{ISO} = 60\text{mA}$
Switching Frequency	f_{OSC}		180		MHz	
PWM Frequency	f_{PWM}		625		kHz	
I_{DD1} Supply Current, Full V_{ISO} load ²	$I_{DD1(MAX)}$		175		mA	$I_{ISO}=100\text{mA}$

¹ All voltages are relative to their respective ground.

² $I_{DD1(MAX)}$ is the input current under full dynamic and V_{ISO} load conditions.

ELECTRICAL CHARACTERISTICS – 5V PRIMARY INPUT SUPPLY / 3.3V SECONDARY ISOLATED SUPPLY¹

4.5 V \leq V_{DD1} \leq 5.5 V, V_{SEL} = GND_{ISO}, all voltages are relative to their respective ground. All min/max specifications apply over the entire recommended operating range, unless otherwise noted. All typical specifications are at T_A = 25°C, V_{DD} = 5.0 V, V_{ISO} = 3.3 V, V_{SEL} = GND_{ISO}.

Table 3.

Parameter	Symbol	Min	Typ	Max	Unit	Test Conditions
Setpoint	V _{ISO}	3.0	3.3	3.6	V	I _{ISO} =0mA
Line Regulation	V _{ISO(LINE)}		1		mV/V	I _{ISO} =50mA, V _{DD1} =4.5V to 5.5V
Load Regulation	V _{ISO(LOAD)}		1	5	%	I _{ISO} = 10mA to 100mA
Output Ripple	V _{ISO(RIP)}		50		mV _{P-P}	20MHz Bandwidth, C _{BO} =0.1μF 10μF, I _{ISO} = 100mA
Output Noise	V _{ISO(N)}		130		mV _{P-P}	20MHz Bandwidth, C _{BO} =0.1μF 10μF, I _{ISO} = 100mA
Switching Frequency	f _{SW}		180		MHz	
PWM Frequency	f _{PWM}		625		kHz	
I _{DD1} Supply Current, Full V _{ISO} load ²	I _{DD1(Max)}		230		mA	I _{ISO} =100mA

¹ All voltages are relative to their respective ground.

² I_{DD1(MAX)} is the input current under full dynamic and V_{ISO} load conditions.

PACKAGE CHARACTERISTICS

Table 4.

Parameter	Symbol	Min	Typ	Max	Unit	Test Conditions
Resistance (Input-to-Output) ¹	R _{I-O}		10 ¹²		Ω	
Capacitance (Input-to-Output) ¹	C _{I-O}		2.2		pF	f = 1 MHz
Input Capacitance ²	C _I		4.0		pF	
IC Junction to Ambient Thermal Resistance	θ _{CA}		45		°C/W	Thermocouple located at center of package underside, test conducted on 4 layer board with thin traces ³ .
Thermal Shutdown						
Thermal Shutdown Threshold	T _{SD}		150		°C	T _J Rising
Thermal Shutdown Hysteresis	T _{SD-HYS}		20		°C	

¹ Device considered a 2-terminal device; Pins 1, 2, 3, 4, 5, 6, 7, and 8 shorted together and Pins 9, 10, 11, 12, 13, 14, 15, and 16 shorted together.

² Input capacitance is from any input data pin to ground.

³ Refer to the Power Considerations section for thermal model definitions

Table 5.

UL (Pending)	CSA (Pending)	VDE (Pending)
Recognized under 1577 component recognition program ¹	Approved under CSA Component Acceptance Notice #5A	Certified according to DIN V VDE V 0884-10 (VDE V 0884-10):2006-12 ²
Reinforced insulation, 2500 V rms isolation voltage	Reinforced insulation per CSA 60950-1-03 and IEC 60950-1, 400 V rms (566 V peak) maximum working voltage	Reinforced insulation, 560 V peak
File E214100	File 205078	File 2471900-4880-0001

¹ In accordance with UL1577, each ADuM5000 is proof tested by applying an insulation test voltage ≥3000 V rms for 1 sec (current leakage detection limit = 5 μA).

² In accordance with DIN V VDE V 0884-10, each ADuM5000 is proof tested by applying an insulation test voltage ≥1050 V peak for 1 sec (partial discharge detection limit = 5 pC). The * marking branded on the component designates DIN V VDE V 0884-10 approval.

INSULATION AND SAFETY-RELATED SPECIFICATIONS

Table 6.

Parameter	Symbol	Value	Unit	Conditions
Rated Dielectric Insulation Voltage		2500	V rms	1 minute duration
Minimum External Air Gap (Clearance)	L(I01)	>8 min	mm	Measured from input terminals to output terminals, shortest distance through air
Minimum External Tracking (Creepage)	L(I02)	>8 min	mm	Measured from input terminals to output terminals, shortest distance path along body
Minimum Internal Gap (Internal Clearance)		0.017 min	mm	Insulation distance through insulation
Tracking Resistance (Comparative Tracking Index)	CTI	>175	V	DIN IEC 112/VDE 0303 Part 1
Isolation Group		IIIa		Material Group (DIN VDE 0110, 1/89, Table 1)

DIN V VDE V 0884-10 (VDE V 0884-10) INSULATION CHARACTERISTICS

These isolators are suitable for reinforced electrical isolation only within the safety limit data. Maintenance of the safety data is ensured by protective circuits. The * marking on packages denotes DIN V VDE V 0884-10 approval.

Table 7.

Description	Conditions	Symbol	Characteristic	Unit
Installation Classification per DIN VDE 0110 For Rated Mains Voltage ≤ 150 V rms For Rated Mains Voltage ≤ 300 V rms For Rated Mains Voltage ≤ 400 V rms			I to IV I to III I to II	
Climatic Classification			40/105/21	
Pollution Degree per DIN VDE 0110, Table 1			2	
Maximum Working Insulation Voltage		V_{IORM}	560	V peak
Input-to-Output Test Voltage, Method B1	$V_{IORM} \times 1.875 = V_{PR}$, 100% production test, $t_m = 1$ sec, partial discharge < 5 pC	V_{PR}	1050	V peak
Input-to-Output Test Voltage, Method A	$V_{IORM} \times 1.6 = V_{PR}$, $t_m = 60$ sec, partial discharge < 5 pC	V_{PR}	896	V peak
After Environmental Tests Subgroup 1			672	V peak
After Input and/or Safety Test Subgroup 2 and Subgroup 3	$V_{IORM} \times 1.2 = V_{PR}$, $t_m = 60$ sec, partial discharge < 5 pC			
Highest Allowable Overvoltage	Transient overvoltage, $t_{TR} = 10$ seconds	V_{TR}	4000	V peak
Safety-Limiting Values	Maximum value allowed in the event of a failure (see Figure 2)			
Case Temperature		T_S	150	°C
Side 1 Current		I_{S1}	265	mA
Side 2 Current		I_{S2}	335	mA
Insulation Resistance at T_S	$V_{IO} = 500$ V	R_S	>10 ⁹	Ω

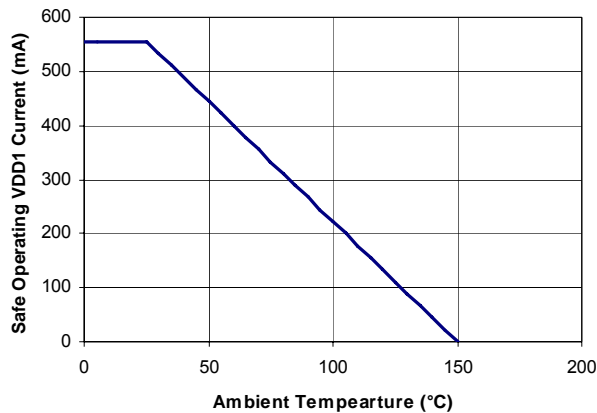

Figure 2. Thermal Derating Curve, Dependence of Safety Limiting Values on Case Temperature, per DIN EN 60747-5-2

RECOMMENDED OPERATING CONDITIONS

Table 8.

Parameter	Symbol	Min	Max	Unit
Operating Temperature	T_A	-40	+85	°C
Supply Voltages ¹				
$V_{DD} @ V_{SEL}=0V$	V_{DD}	2.7	5.5	V
$V_{DD} @ V_{SEL}=5V$	V_{DD}	4.5	5.5	V

¹ All voltages are relative to their respective ground.

ABSOLUTE MAXIMUM RATINGS

Ambient temperature = 25°C, unless otherwise noted.

Table 9.

Parameter	Rating
Storage Temperature (T_{ST})	-55°C to +150°C
Ambient Operating Temperature (T_A)	-40°C to +105°C
Supply Voltages (V_{DD} , V_{ISO}) ¹	-0.5 V to +7.0 V
Input Voltage (C_{TR}, R_{CIN}, V_{SEL}) ^{1,2}	-0.5 V to $V_{DDI} + 0.5$ V
Output Voltage (R_{COUT}) ^{1,2}	-0.5 V to $V_{DDO} + 0.5$ V
Average Total Output Current ³ I_{ISO}	100mA
Common-Mode Transients ⁴	-100 kV/ μ s to +100 kV/ μ s

¹ All voltages are relative to their respective ground.

² V_{DDI} and V_{DDO} refer to the supply voltages on the input and output sides of a given channel, respectively. See the PC Board Layout section.

³ See Figure 2 for maximum rated current values for various temperatures.

⁴ Refers to common-mode transients exceeding the Absolute Maximum Ratings may cause latch-up or permanent damage.

Stresses above those listed under Absolute Maximum Ratings may cause permanent damage to the device. This is a stress rating only; functional operation of the device at these or any other conditions above those indicated in the operational section of this specification is not implied. Exposure to absolute maximum rating conditions for extended periods may affect device reliability.

ESD CAUTION



ESD (electrostatic discharge) sensitive device. Charged devices and circuit boards can discharge without detection. Although this product features patented or proprietary protection circuitry, damage may occur on devices subjected to high energy ESD. Therefore, proper ESD precautions should be taken to avoid performance degradation or loss of functionality.

Table 10. Maximum Continuous Working Voltage¹

Parameter	Max	Unit	Constraint
AC Voltage, Bipolar Waveform	424	V peak	50-year minimum lifetime
AC Voltage, Unipolar Waveform		V peak	
Basic Insulation	600	V peak	Maximum approved working voltage per IEC 60950-1
Reinforced Insulation	560	V peak	Maximum approved working voltage per IEC 60950-1 and VDE V 0884-10
DC Voltage			
Basic Insulation	600	V peak	Maximum approved working voltage per IEC 60950-1
Reinforced Insulation	560	V peak	Maximum approved working voltage per IEC 60950-1 and VDE V 0884-10

¹ Refers to continuous voltage magnitude imposed across the isolation barrier. See the Insulation Lifetime section for more details.

Table 11. Truth Table (Positive Logic)

R_{CSEL} Input	R_{CIN} Input	R_{COUT} Output	V_{SEL} Input ¹	V_{DDI} Input	V_{ISO} Output	Notes
H	X	FB-PWM	H	5.0V	5.0V	Master mode operation, Self Regulating
H	X	FB-PWM	L	5.0V	3.3V	Master mode operation, Self Regulating
H	X	FB-PWM	H	3.3V	5.0V	Master mode operation, Self Regulating
H	X	FB-PWM	L	3.3V	3.3V	Master mode operation, Self Regulating
L	EXT-PWM	R_{CIN}	X	5.0V	X	Slave mode operation, Regulation from another <i>iso</i> Power part.
L	L	L	L	X	X	Low power mode, Converter disabled
L	H	X	X	X	X	WARNING! This combination of R_{CIN} and R_{CSEL} is prohibited. Damage will occur on the secondary due to excess output voltage at V_{ISO} . R_{CIN} must be either Low or a PWM signal from a master <i>iso</i> Power part..

PIN CONFIGURATION AND FUNCTION DESCRIPTIONS

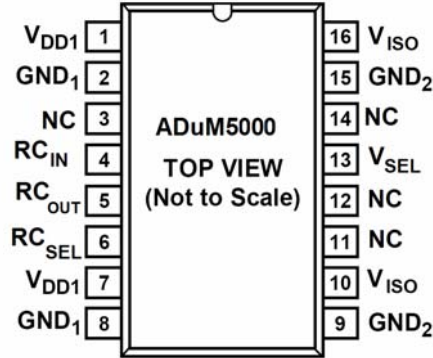

Figure 3. ADuM5200 Pin Configuration

Table 12. ADuM5000 Pin Function Descriptions

Pin No.	Mnemonic	Description
1	V _{DD1}	Primary Supply Voltage 3.0V to 5.5 V. Pin 1 and Pin 7 are internally connected, and connecting both to V _{DD1} is recommended
2,8	GND ₁	Ground 1. Ground reference for converter Primary. Pin 2 and Pin 8 are internally connected, and it is recommended that both pins be connected to a common ground.
3	NC	No Internal Connection.
4	RC _{IN}	Regulation Control Input, In slave power configuration (RC _{SEL} =Low), this pin is connected to the RC _{OUT} of a master isoPower device, or tied low to disable the converter. In Master/Stand alone mode(RC _{SEL} =High) this pin has no function. This pin is weakly pulled to low. In Noisy environments it should be tied to low or to a PWM control source. Warning -This pin must not be tied high if RC _{SEL} is low, this combination will cause excessive volatage on the secondary, damaging the ADuM5000 and possibly devices that it powers.
5	RC _{OUT}	Regulation Control Output, In master power configuration, this pin is connected to the RC _{IN} of a slave isoPower device to allow the ADuM5000 to regulate additional devices.
6	RC _{SEL}	Control input, Determines Master/self regulation (CTL High) mode or Slave mode(CTL Low)allowing external regulation. This pin is weakly pulled to high. In noisy environments it should be tied either high or low.
7	V _{DD1}	Primary Supply Voltage 3.0V to 5.5 V. Pin 1 and Pin 7 are internally connected, and connecting both to V _{DD1} is recommended.
9,15	GND _{ISO}	Ground reference for converter Secondary. Pin 9 and Pin 15 are internally connected, and it is recommended that both pins be connected to a common ground.
10	V _{ISO}	Secondary Supply Voltage Output External Loads, 3.3V (VSEL Low) or 5.0V (VSEL High), 5.0V output Functionlity not guaranteed for a 3.3V primary supply input. Pin 10 and Pin 16 are internally connected, and connecting both to GND _{ISO} is recommended.
11	NC	No Internal Connection.
12	NC	No Internal Connection.
13	V _{SEL}	Output Voltage Selection: When V _{SEL} = V _{ISO} then the Viso set point is 5.0V, When V _{SEL} = GND _{ISO} Then the VISO setpoint is 3.3V. This pin is weakly pulled to high. In noisy environments it should be tied either high or low. In Slave regulation mode this pin has no function.
14	NC	No Internal Connection.
16	V _{ISO}	Secondary Supply Voltage Output External Loads, 3.3V (VSEL Low) or 5.0V (VSEL High), 5.0V output Functionlity not guaranteed for a 3.3V primary supply input. Pin 10 and Pin 16 are internally connected, and connecting both to GND _{ISO} is recommended.

Typical Performance Characteristics

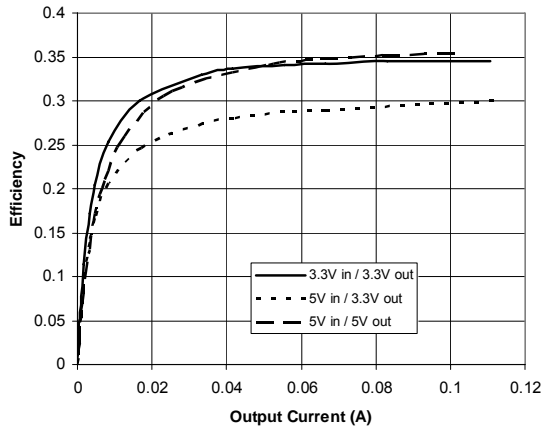

Figure 4. Typical Power Supply Efficiency at 5V/5V, 3.3V/3.3V and 5V/3.3V

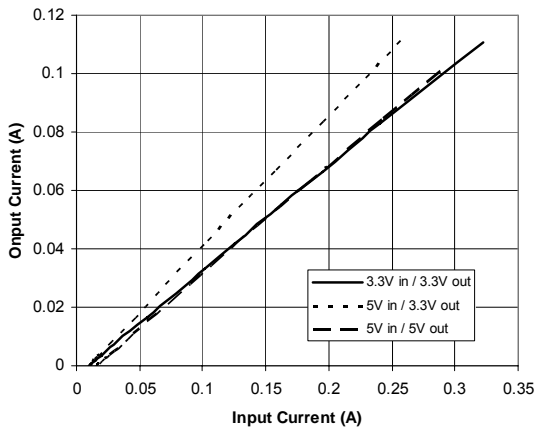

Figure 5. Typical Isolated Output Supply Current, I_{ISO} as a function of external load, no dynamic current draw at 5V/5V, 3.3V/3.3V and 5V/3.3V

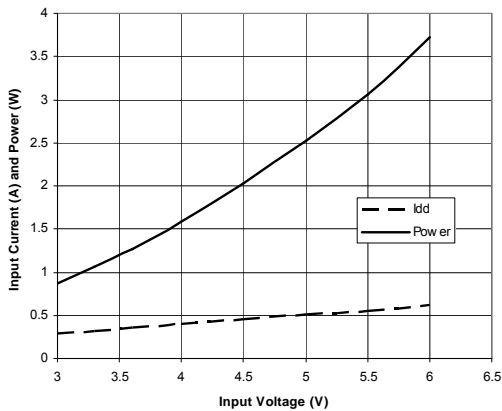

Figure 6. Typical Short Circuit Input Current and Power vs. V_{DD} supply voltage

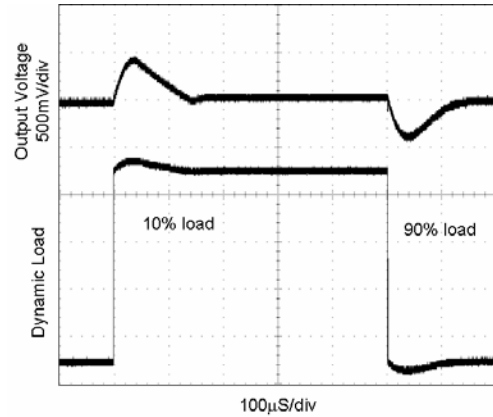

Figure 7. Typical V_{ISO} Transient Load Response 5V Output 10%-90% Load Step

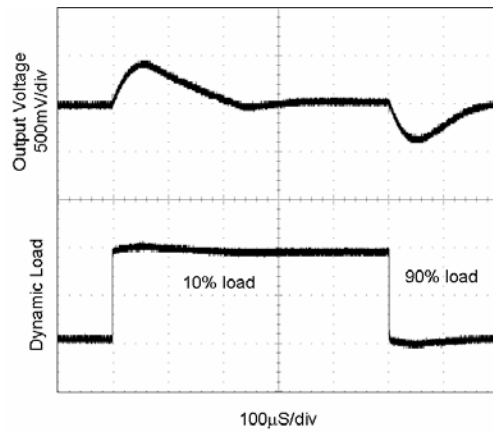

Figure 8. Typical Transient Load Response 3V Output 10%-100% Load Step

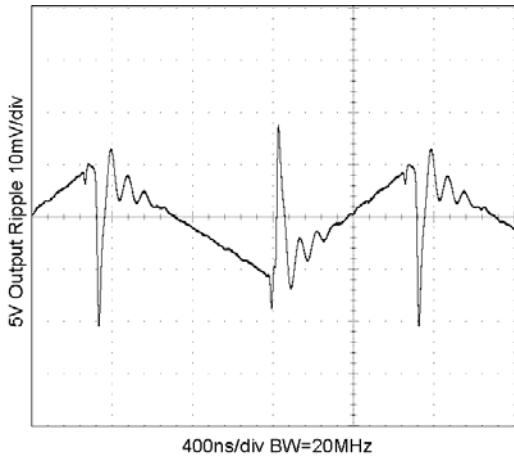

Figure 9. Typical $V_{iso}=5V$ Output Voltage Ripple at 90% Load

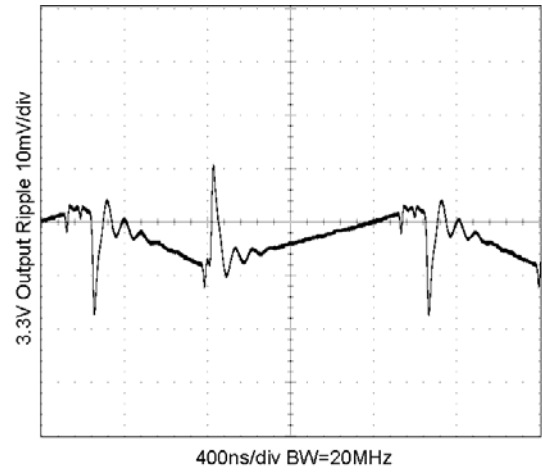

Figure 10. Typical $V_{iso}=3.3V$ Output Voltage Ripple at 90% Load

APPLICATION INFORMATION

THEORY OF OPERATION

The DC/DC converter section of the ADuM5000 works on principles that are common to most modern power supply designs. It is implemented as a secondary side controller with isolated PWM feedback. V_{DD1} power is supplied to an oscillating circuit that switches current into a chip-scale air core transformer. Power is transferred to the secondary side where it is rectified to a DC voltage. The power is then regulated to either 3.3 or 5V and supplied to the secondary side data section and to the V_{ISO} pin for external use. Active feedback is implemented by a digital feedback path. The output regulator creates a pulse width modulated signal which is coupled to the input side and switches the oscillator on and off regulating the power. Feedback allows for significantly higher power, efficiency, and synchronization of multiple supplies.

The ADuM5000 provides its Regulation Control output (RCout) signal that can be connected to other isoPower devices. This allows a single regulator to control multiple power modules without contention. When auxiliary power modules are present, the V_{ISO} pins can be connected together to work as a single supply. Since there is only one feedback control path, the supplies will work together seamlessly. The ADuM5000 can only be a source of Regulation Control, other devices

There is hysteresis into the input V_{DD} input voltage detect circuit. Once the DC/DC converter is active, the input voltage must be decreased below the turn on threshold to disable the converter. This feature ensures that the converter does not go into oscillation due to noisy input power.

PC BOARD LAYOUT

The ADuM5000 digital isolator with a $\frac{1}{2}W$ isoPower integrated DC/DC converter requires no external interface circuitry for the logic interfaces. Power supply bypassing is required at the input and output supply pins (Figure 11). The power supply section of the ADuM5000 uses a very high oscillator frequency to efficiently pass power through its chip scale transformers. In addition, the normal operation of the data section of the iCoupler introduces switching transients on the power supply pins. Bypass capacitors are required for several operating frequencies. Noise suppression requires a low inductance high frequency capacitor, ripple suppression and proper regulation require a large value capacitor. These are most conveniently connected between Pins 1 and 2 for V_{DD1} and between Pins 15 and 16 for V_{ISO} . To suppress noise and reduce ripple, a parallel combination of at least two capacitors is required. The recommended capacitor values are 0.1 μ F, and 6.6 μ F. It is strongly recommended that a very low inductance ceramic or equivalent capacitor be used for the smaller value. The total lead length between both ends of the capacitor and the input power supply pin should not exceed 20 mm. Bypassing between Pins 1

and 8 and between Pins 9 and 16 should also be considered unless the both of the common ground pins are connected together close to the package.

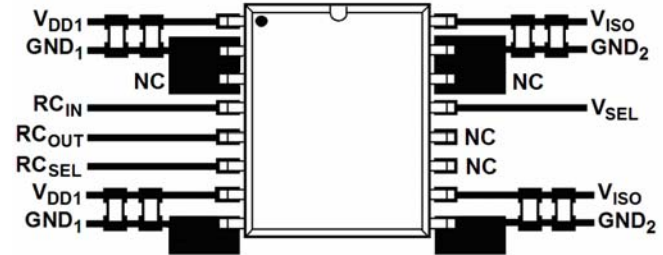

Figure 11. Recommended Printed Circuit Board Layout

In applications involving high common-mode transients, care should be taken to ensure that board coupling across the isolation barrier is minimized. Furthermore, the board layout should be designed such that any coupling that does occur equally affects all pins on a given component side. Failure to ensure this could cause voltage differentials between pins exceeding the device's Absolute Maximum Ratings, specified in Table 9 thereby leading to latch-up and/or permanent damage.

The ADuM5000 is a power device that dissipates about 1W of power when fully loaded and running at maximum speed. Since it is not possible to apply a heat sink to an isolation device, the device primarily depends on heat dissipation into the PCB through the GND pins. If the device will be used at high ambient temperatures, care should be taken to provide a thermal path from the GND pins to the PCB ground plane. The board layout in Figure 11 shows enlarged pads for pins 2, 8, 9, and 15. Multiple vias should be implemented from the pad to the ground plane. This will significantly reduce the temperatures inside of the chip. The dimensions of the expanded pads are left to discretion of the designer and the available board space.

THERMAL ANALYSIS

The ADuM5000 parts consist of four internal die, attached to a split lead frame with two die attach paddles. For the purposes of thermal analysis it is treated as a thermal unit with the highest junction temperature reflected in the θ_{JA} from Table 4. The value of θ_{JA} is based on measurements taken with the part mounted on a JEDEC standard 4 layer board with fine width traces and still air. Under normal operating conditions the ADuM5000 will operate at full load across the full temperature range without derating the output current. However, following the recommendations in the PC Board Layout section will decrease the thermal resistance to the PCB allowing increased thermal margin at high ambient temperatures.

CURRENT LIMIT AND THERMAL OVERLOAD PROTECTION

The ADuM5000 is protected against damage due to excessive power dissipation by thermal overload protection circuits. Thermal overload protection limits the junction temperature to a maximum of 150°C (typical). Under extreme conditions (that is, high ambient temperature and power dissipation) when the junction temperature starts to rise above 150°C, the PWM is turned off, reducing the output current to zero. When the junction temperature drops below 130°C (typical), the PWM is turned on again and output current is restored to its nominal value.

Consider the case where a hard short from V_{ISO} to ground occurs. At first, the ADuM5000 reaches its maximum current, which is proportional to the voltage applied at V_{DD1}. Power is dissipated in the primary (see **Error! Reference source not found.**). If self-heating of the junction becomes great enough to cause its temperature to rise above 150°C, thermal shutdown activates, turning off the PWM and reducing the output current to zero. As the junction temperature cools and drops below 130°C, the PWM turns on and power is again dissipated in the primary, again causing the junction temperature to rise above 150°C. This thermal oscillation between 130°C and 150°C causes a current oscillation that continues as long as the short remains at the output.

Thermal limit protections are intended to protect the device against accidental overload conditions. For reliable operation, device power dissipation should be externally limited so junction temperatures do not exceed 130°C.

POWER CONSIDERATIONS

The ADuM5000 Converter Primary side, is protected from premature operation by Under Voltage Lock Out (UVLO) circuitry. Below the minimum operating voltage, the power converter holds its oscillator inactive.

INCREASING AVAILABLE POWER

The ADuM5000 devices are designed with capability of running in combination with other compatible isoPower devices. The RC_{OUT} RC_{IN} and RC_{SEL} pins allow the ADuM5000 to provide its PWM signal to another device through the RC_{OUT} pin acting as a master. It can also receive a PWM signal from another device through the RC_{IN} pin and act as a slave to that control signal. The RC_{SEL} pin chooses whether the part will act as a master or slave device. When the ADuM5000 is acting as a slave, its power is regulated by the master device allowing multiple isoPower parts to be combined in parallel while sharing the load equally. When the ADuM5000 is configured as a Master/Stand alone unit, it generates its own PWM feedback signal to regulate itself and slave devices.

The ADuM5000 can act as a master or a slave device, the ADuM5400 can only be a master/stand alone, and the ADuM5200 can only be a slave/Stand alone device. This means

that the ADuM5000, ADuM5200, and ADuM5400 can only be used in certain master slave combinations as listed in Table 13.

		Slave		
		ADuM5000	ADuM5200	ADuM5400
Master	ADuM5000	Y	Y	N
	ADuM5200	N	N	N
	ADuM5400	Y	Y	N

Table 13 Allowed combinations of isoPower Parts

The allowed combinations of master and slave configured parts listed in Table 13 is sufficient to make any combination of power and channel count. Table 14 illustrates how isoPower devices can provide many combinations of data channel count and multiples of the single unit power.

	Number of Data Channels			
	0	2	4	6
1 Unit Power	ADuM5000 Master	ADuM520x Master	ADuM540x Master	ADuM540x Master ADuM12xx
2 Unit Power	ADuM5000 Master ADuM5000 Slave	ADuM500x Master ADuM5200 Slave	ADuM540x Master ADuM5200 Slave	ADuM540x Master ADuM520x Slave
3 Unit Power	ADuM5000 Master ADuM5000 Slave ADuM5000 Slave	ADuM5000 Master ADuM5000 Slave ADuM520x Slave	ADuM540x Master ADuM5000 Slave ADuM5000 Slave	ADuM540x Master ADuM520x Slave ADuM5000 Slave

Table 14 Configurations for Power and Data Channels

INSULATION LIFETIME

All insulation structures will eventually break down when subjected to voltage stress over a sufficiently long period. The rate of insulation degradation is dependant on the characteristics of the voltage waveform applied across the insulation. In addition to the testing performed by the regulatory agencies, Analog Devices carries out an extensive set of evaluations to determine the lifetime of the insulation structure within the ADuM5000.

ADI performs accelerated life testing using voltage levels higher than the rated continuous working voltage. Acceleration factors for several operating conditions are determined. These factors allow calculation of the time to failure at the actual working voltage. The values shown in Table 10 summarize the peak voltage for 50 years of service life for a bipolar ac operating condition, and the maximum CSA/VDE approved working voltages. In many cases, the approved working voltage is higher than 50-year service life voltage. Operation at these high working voltages can lead to shortened insulation life in some cases.

The insulation lifetime of the ADuM5000 depends on the

voltage waveform type imposed across the isolation barrier. The iCoupler insulation structure degrades at different rates depending on whether the waveform is bipolar ac, unipolar ac, or dc. Figure 12, Figure 13, and Figure 14 illustrate these different isolation voltage waveforms.

Bipolar ac voltage is the most stringent environment. The goal of a 50-year operating lifetime under the ac bipolar condition determines ADI's recommended maximum working voltage.

In the case of unipolar ac or dc voltage, the stress on the insulation is significantly lower. This allows operation at higher working voltages while still achieving a 50 year service life. The working voltages listed in Table 10 can be applied while maintaining the 50-year minimum lifetime provided the voltage conforms to either the unipolar ac or dc voltage cases. Any cross insulation voltage waveform that does not conform to Figure 13¹ or Figure 14 should be treated as a bipolar ac waveform and its peak voltage should be limited to the 50 year lifetime voltage value listed in Table 10.

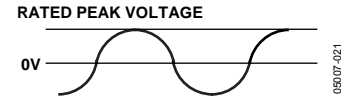

Figure 12. Bipolar AC Waveform

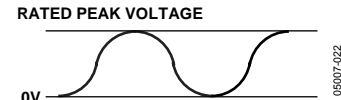

Figure 13. Unipolar AC Waveform

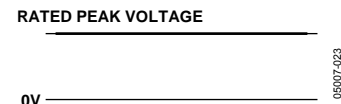
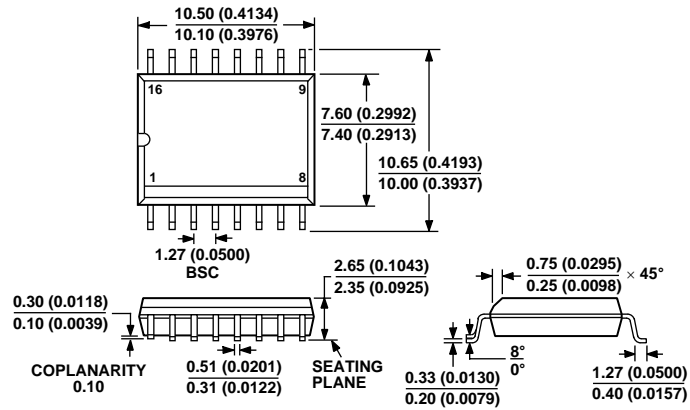

Figure 14. DC Waveform

¹ The voltage presented in Figure 13 is shown as sinusoidal for illustration purposes only. It is meant to represent any voltage waveform varying between 0 and some limiting value. The limiting value can be positive or negative, but the voltage cannot cross 0V.

OUTLINE DIMENSIONS



COMPLIANT TO JEDEC STANDARDS MS-013-AA
 CONTROLLING DIMENSIONS ARE IN MILLIMETERS; INCH DIMENSIONS
 (IN PARENTHESES) ARE ROUNDED-OFF MILLIMETER EQUIVALENTS FOR
 REFERENCE ONLY AND ARE NOT APPROPRIATE FOR USE IN DESIGN.

Figure 15. 16-Lead Standard Small Outline Package [SOIC_W]
 Wide Body (RW-16)
 Dimension shown in millimeters and (inches)

ORDERING GUIDE

Model	Number of Inputs, V _{DD1} Side	Number of Inputs, V _{DD2} Side	Maximum Data Rate (Mbps)	Maximum Propagation Delay, 5 V (ns)	Maximum Pulse Width Distortion (ns)	Temperature Range (°C)	Package Option
ADuM5200ARWZ ¹	0	0	0	0	0	-40 to +105	16-Lead SOIC_W

¹ Tape and reel are available. The additional "-RL7" suffix designates a 7" (1,000 units) tape and reel options.