



1 Form C
 Solid State Relay

DESCRIPTION

The AD6C223 is composed of two distinct relays; one normally open and one normally closed sharing a common input, making this a true 1 Form C device. Each relay has a bi-directional, single-throw contact controlled simultaneously by an LED driver. The driver activates an integrated circuit, which in turn drives each pair of DMOS transistors. These transistors are protected with free-wheeling diodes that can handle up to 1.5A of inrush current, making the relay ideal for switching lamps and highly inductive loads.

FEATURES

- True 1 Form C device
- Low input control power consumption (5mA MAX)
- 150mA maximum continuous load current
- 25 ohms maximum on-resistance (Form A)
- 25 ohms maximum on-resistance (Form B)
- High input-to-output isolation
- Long life/high reliability

OPTIONS/SUFFIXES*

- -S Surface Mount Leadform Option
- -TR Tape and Reel Option

NOTE: Suffixes listed above are not included in marking on device for part number identification.

SCHEMATIC DIAGRAM

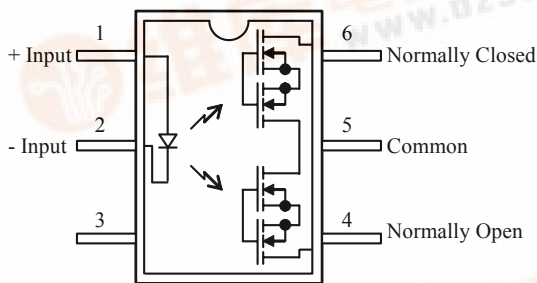

APPLICATIONS

- Reed relay replacement
- Meter reading systems
- Medical equipment
- Battery monitoring
- Multiplexers

ABSOLUTE MAXIMUM RATINGS*

PARAMETER	UNIT	MIN	TYP	MAX
Storage Temperature	°C	-55		125
Operating Temperature	°C	-40		85
Continuous Input Current	mA			50
Transient Input Current	mA			400
Reverse Input Control Voltage	V	6		
Output Power Dissipation	mW			600

*The values indicated are absolute stress ratings. Functional operation of the device is not implied at these or any conditions in excess of those defined in electrical characteristics section of this document. Exposure to Absolute Ratings may cause permanent damage to the device and may adversely affect reliability.

APPROVALS

- BAPT CERTIFICATE #607836:
 BS EN 60950, BS EN 41003, BS EN 60065
- CSA CERTIFICATE #LR111581-1
- UL FILE #E90096

ELECTRICAL CHARACTERISTICS - 25°C

PARAMETER	UNIT	MIN	TYP	MAX	TEST CONDITIONS
INPUT SPECIFICATIONS					
LED Forward Voltage	V		1.2	1.5	I _f = 5mA
LED Reverse Voltage	V	6	12		I _r = 10uA
Turn-On Current (Form A)	m A		2	5	I _o = 150mA
Turn-On Current (Form B)	m A		0.5		
Turn-Off Current (Form A)	m A		0.5		
Turn-Off Current (Form B)	m A		2	5	I _o = 150mA
OUTPUT SPECIFICATIONS (NORMALLY OPEN)					
Blocking Voltage	V	400			I _o = 1uA
Continuous Load Current	m A			150	I _f = 5mA
On-Resistance	Ω		17	25	I _o = 150mA
Leakage Current	μ A		0.2	1	V _o = 400V
Output Capacitance	p F		25	50	V _o = 25V, f = 1.0MHz
Offset Voltage	m V			0.2	I _f = 5mA
Turn-On Time	m s		0.5	5	I _f = 5mA, I _o = 150mA
Turn-Off Time	m s		0.05	5	I _f = 0mA, I _o = 150mA
OUTPUT SPECIFICATIONS (NORMALLY CLOSED)					
Blocking Voltage	V	400			I _o = 1uA
Continuous Load Current	m A			150	I _f = 0mA
On-Resistance	Ω		22	25	I _o = 150mA
Leakage Current	μ A		0.2	1	V _o = 400V
Output Capacitance	p F		15	20	V _o = 25V, f = 1.0MHz
Offset Voltage	m V			0.2	
Turn-On Time	m s		0.5	5	I _f = 0mA, I _o = 150mA
Turn-Off Time	m s		0.5	5	I _f = 5mA, I _o = 150mA
COUPLED SPECIFICATIONS					
Isolation Voltage	V	2500			T = 1 minute
-H Suffix	V	3750			T = 1 minute
Isolation Resistance	G Ω	100			
Coupled Capacitance	p F			2	
Contact Transient Ratio	V / μ s	2000	7000		dV = 50V

PERFORMANCE DATA

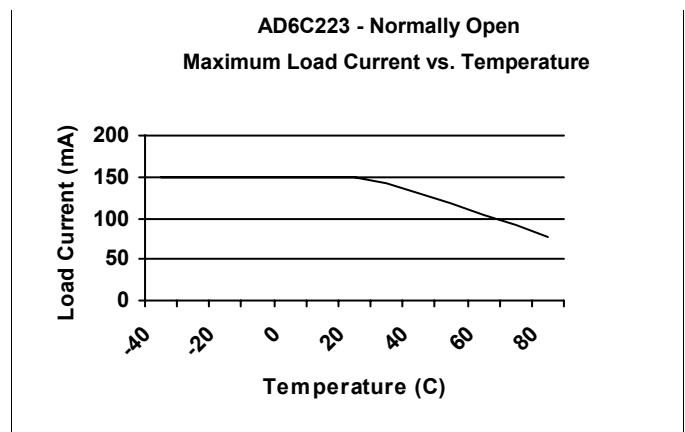
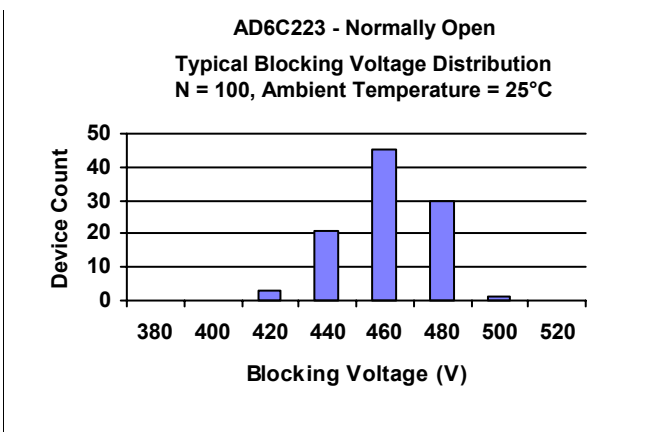
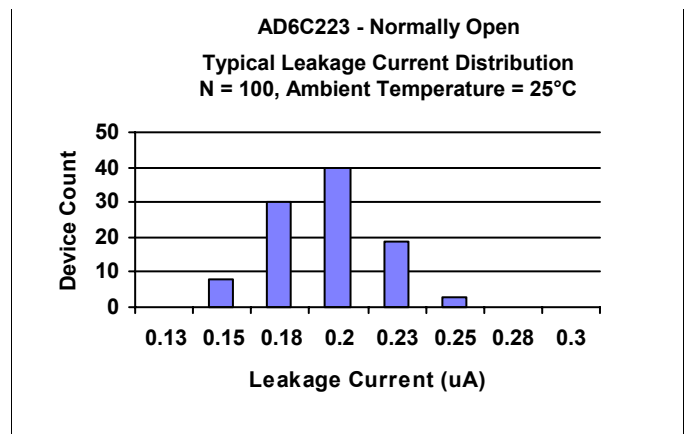
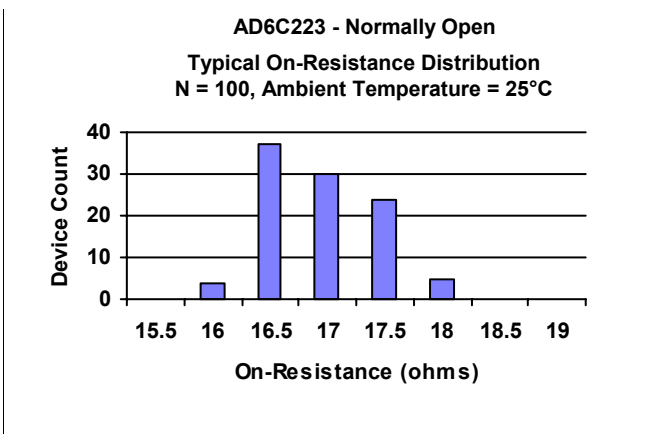
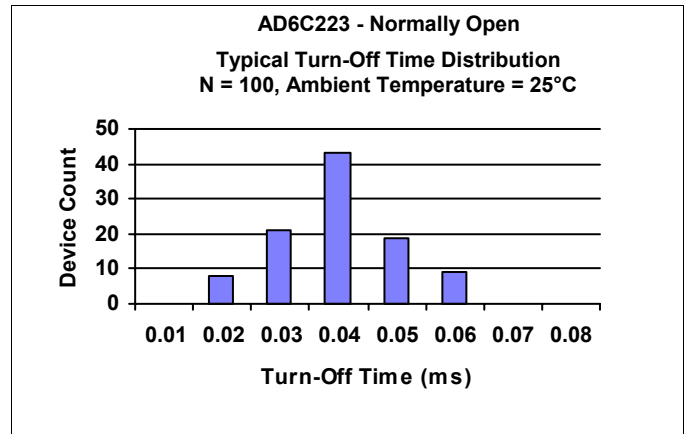
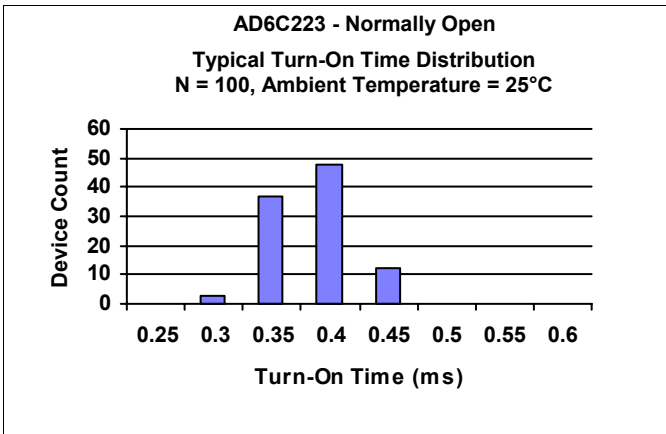

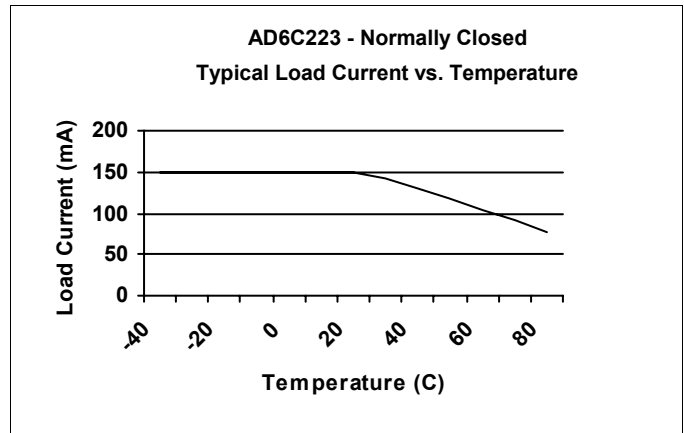
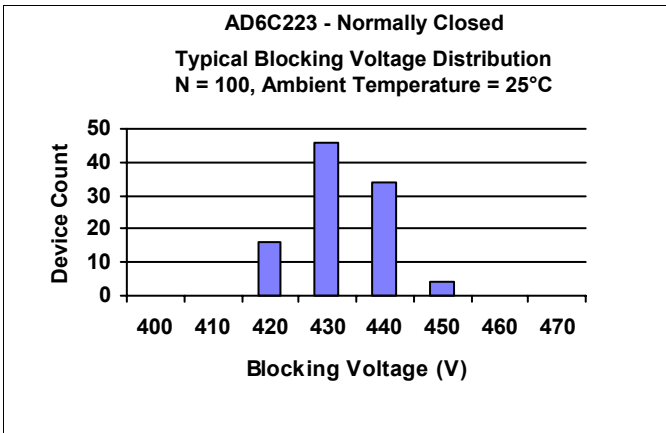
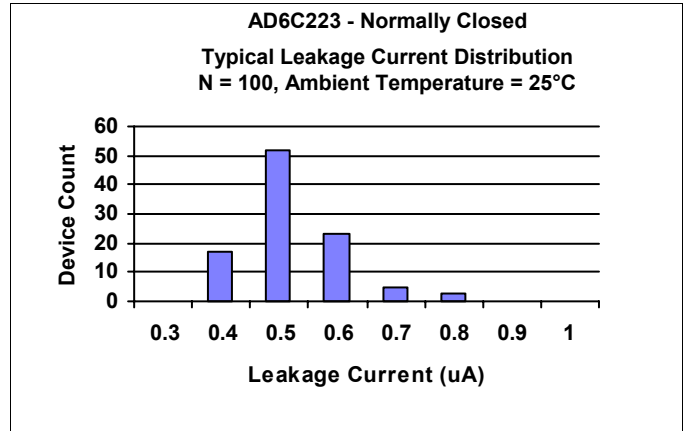
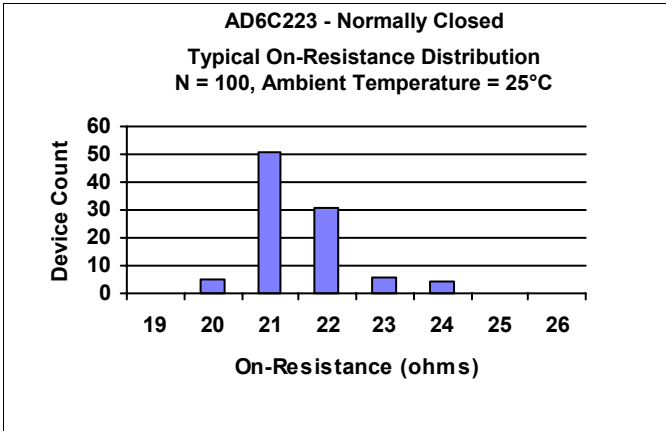
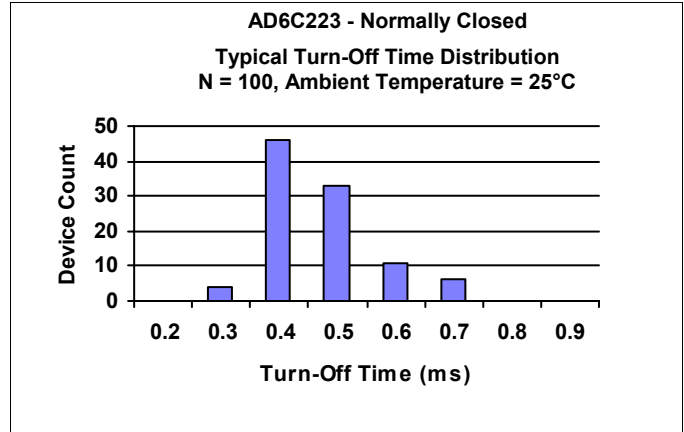
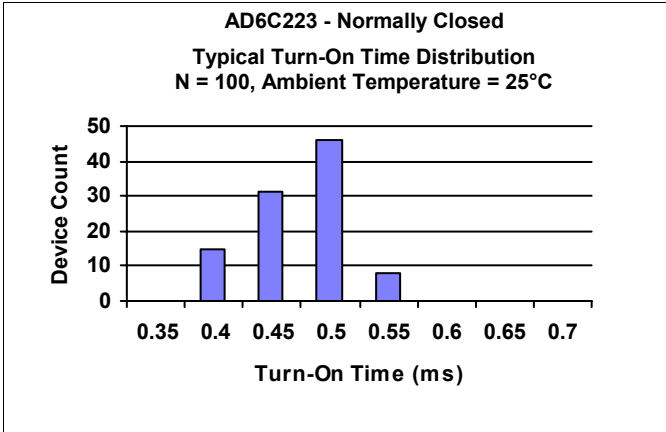

MECHANICAL DIMENSIONS

6 PIN DUAL IN-LINE PACKAGE

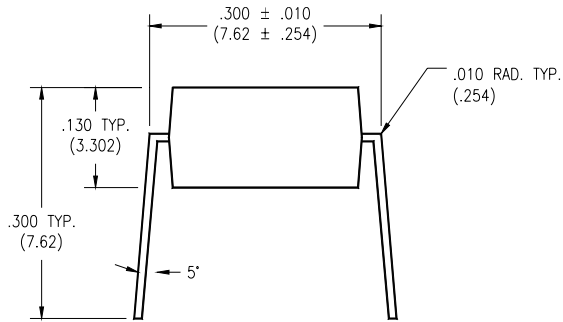

END VIEW

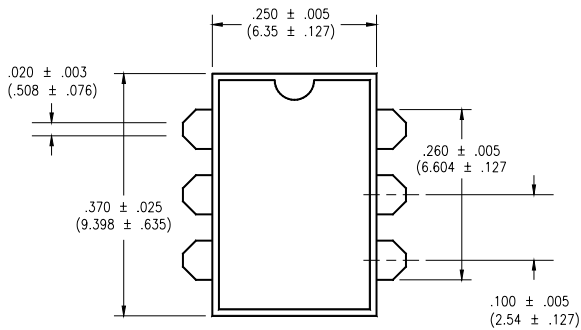

TOP VIEW

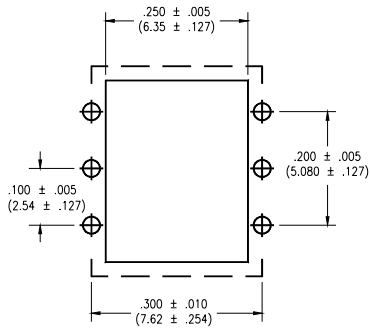

**BOTTOM VIEW/
BOARD PATTERN**

6 PIN SURFACE MOUNT DEVICE

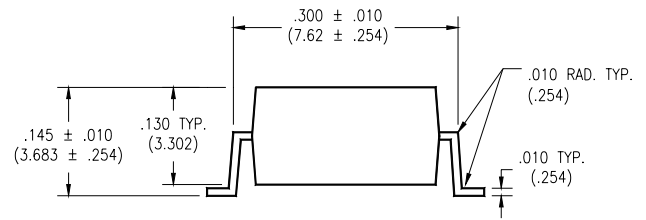

END VIEW

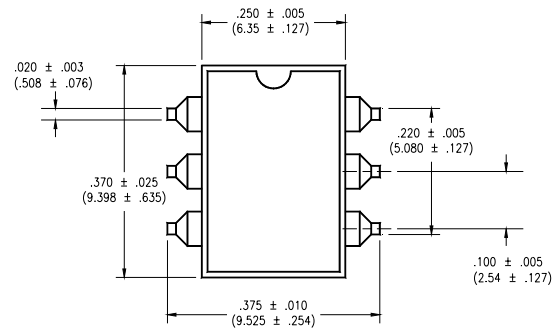

TOP VIEW

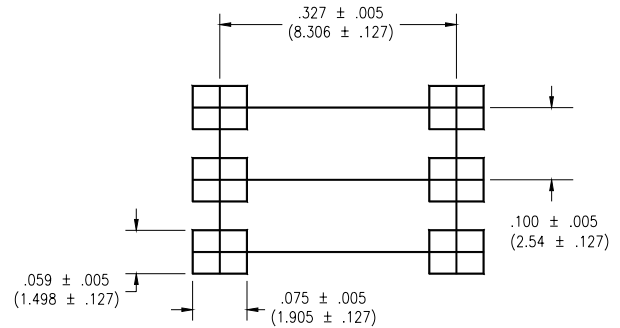

**BOTTOM VIEW/
BOARD PATTERN**

DISCLAIMER

Solid State Optronics (SSO) makes no warranties or representations with regards to the completeness and accuracy of this document. SSO reserves the right to make changes to product description, specifications at any time without further notice. SSO shall not assume any liability arising out of the application or use of any product or circuit described herein. Neither circuit patent licenses nor indemnity are expressed or implied. Except as specified in SSO's Standard Terms & Conditions, SSO disclaims liability for consequential or other damage, and we make no other warranty, expressed or implied, including merchantability and fitness for particular use.

LIFE SUPPORT POLICY

SSO does not authorize use of its devices in life support applications wherein failure or malfunction of a device may lead to personal injury or death. Users of SSO devices in life support applications assume all risks of such use and agree to indemnify SSO against any and all damages resulting from such use. Life support devices are defined as devices or systems which, (a) are intended for surgical implant into the body, or (b) support or sustain life, and (c) whose failure to perform when used properly in accordance with instructions for use can be reasonably expected to result in significant injury to the user, or (d) a critical component in any component of a life support device or system whose failure can be reasonably expected to cause failure of the life support device or system, or to affect its safety or effectiveness.
