



=Preliminary=

AK8973

3-axis Electronic Compass

1. Features

- 3-axis electronic compass IC
- Optimal built-in electronic compass for mobile phones and handy terminals
- High sensitivity Hall sensors are integrated.
- Functions
 - Built-in 8-bit ADC
 - Built-in amplifier for sensor signal amplification
 - Built-in 8-bit DAC for sensor signal offset compensation
 - Built-in EEPROM for storing individual adjustment values
 - Built-in temperature sensor
 - 8-bit digital output
 - Serial interface: I²C bus interface (supporting the low-voltage specification)
 - Automatic power-down function
 - Interrupt function for measurement data ready
 - Built-in master clock oscillator
- Operating temperatures: -30°C to +85°C
- Operating supply voltage: +2.5V to +3.6V
- Low current consumption/measurement time:
 - Power-down: 0.2μA typ.
 - Magnetic sensor driving: 6.8mA/12.6ms
- Package: 16-pin QFN package: 4.0mm×4.0mm×0.7mm

2. Overview

AK8973 is a geomagnetism detection type electronic compass IC.

The small package of AK8973 integrates magnetic sensors for detecting geomagnetism in the X-axis, Y-axis, and Z-axis, and arithmetic circuit for processing the signal from each sensor. AK8973 outputs four data in total as 8-bit digital values respectively: 3-axis magnetic sensor measured values and temperature sensor read value. By processing the magnetic sensor measured values with an external CPU, azimuth data can be obtained.

By using AK8973 integrated into the system, a navigation system is achieved with reduced space in portable equipment such as PDA or mobile phone incorporating the GPS function.

Specifically, AK8973 has the following features:

- (1) Due to the built-in 8-bit ADC and serial interface, geomagnetism of the X-axis, Y-axis, and Z-axis can be detected as digital data.
- (2) The serial interface corresponds to the I²C bus.
- (3) A dedicated power supply is used for the serial interface, so the low-voltage specification can also be supported by applying 1.85V.
- (4) Due to the built-in DAC for compensating the offset magnetic field, the position restraint with parts which generate the offset magnetic field such as speakers is reduced, and the degree of freedom about layout is expanded. Note 1)
- (5) An EEPROM for storing the individual adjustment values of sensor sensitivity is built-in. The adjustment values are stored in factory at the time of shipment from AKM.
- (6) The built-in temperature sensor as an accessory generates the 8-bit digital A/D-converted value. The temperature information is not used for azimuth calculation.
- (7) The major circuit blocks of AK8973 are activated by the measurement request command from the controller, and transit to the power-down mode automatically at the end of measurement. That characteristic realizes the low power consumption required for mobile phones.
- (8) The interrupt function for posting the completion of sensor signal measurement to the external CPU is built-in.
- (9) The master clock oscillator is built-in. It is unnecessary to supply the clock from the outside.

Note 1) For AK8973, the offset magnetic field compensation range is approximately $\pm 2.0\text{mT}$ (typical geomagnetism range is approximately 0.05mT). Depending on usage or required accuracy, use with the full-range is available. However, for the azimuth measurement by the mobile phones, it is important to regard the following in the design phase: the magnetic field intensity of offset magnetic field source (e.g. magnet of speaker) is not fully controlled, and the temperature characteristic dispersion is noted. With AK8973, it is recommended that the design be performed with the parts layout where the offset magnetic field of each measurement axis is $\pm 0.8\text{mT}$ or less.

3. Table of Contents

1.	Features	1
2.	Overview	2
3.	Table of Contents	3
4.	Circuit Configuration	5
4.1.	Block Diagram	5
4.2.	Block Function	6
4.3.	Pin Function	7
5.	Overall Characteristics	8
5.1.	Absolute Maximum Ratings	8
5.2.	Recommended Operating Conditions	8
5.3.	Electrical Characteristics	8
5.3.1.	DC Characteristics	8
5.3.2.	EEPROM Characteristics	9
5.3.3.	Analog Circuit Characteristics	9
5.4.	Detailed Timing	9
5.4.1.	Various Timing	9
5.4.2.	I ² C Bus Interface	10
6.	Functional Explanation	11
6.1.	Operation Modes	11
6.2.	Description of Each Operation Mode	12
6.2.1.	Power-down Mode	12
6.2.2.	Sensor Measurement Mode	12
6.2.3.	EEPROM Mode	13
6.3.	Interrupt Function based on INT Pin	13
7.	Serial Interface	14
7.1.	Data Transfer	14
7.1.1.	Change of Data	14
7.1.2.	Start/Stop Condition	14
7.1.3.	Acknowledge	15
7.1.4.	Slave Address	15
7.2.	WRITE Instruction	16
7.3.	READ Instruction	17
7.3.1.	Current Address READ	17
7.3.2.	Random READ	17
8.	Registers	18
8.1.	Description of Registers	18
8.2.	Register Map	19
8.3.	Detailed Description of Registers	20
8.3.1.	ST: Status Register	20
8.3.2.	TMPS: Temperature Sensor Data Register	20
8.3.3.	H1X, H1Y, H1Z: Sensor Data Register	21
8.3.4.	MS1: Mode Setting Register 1	21
8.3.5.	HXDA, HYDA, HZDA: Magnetic Sensor DAC Setting Register	22
8.3.6.	HXGA, HYGA, HZGA: Magnetic Sensor Gain Setting Register	23
9.	EEPROM	24
9.1.	Outline of the Function	24
9.2.	Operation Description	25
9.2.1.	READ Instruction	25
9.2.1.1.	Current Address READ	25
9.2.1.2.	Random READ	25
9.2.2.	WRITE Instruction	26
9.2.2.1.	Byte-Write	26
9.3.	Memory Map	27
10.	Example of Recommended External Connection	28
11.	Package	29
11.1.	Marking	29
11.2.	Pin Assignment	29

11.3. Outline Dimensions	30
11.4. Recommended Foot Print Pattern	30
12. Relationship between the Magnetic Field and Output Code.....	31

4. Circuit Configuration

4.1. Block Diagram

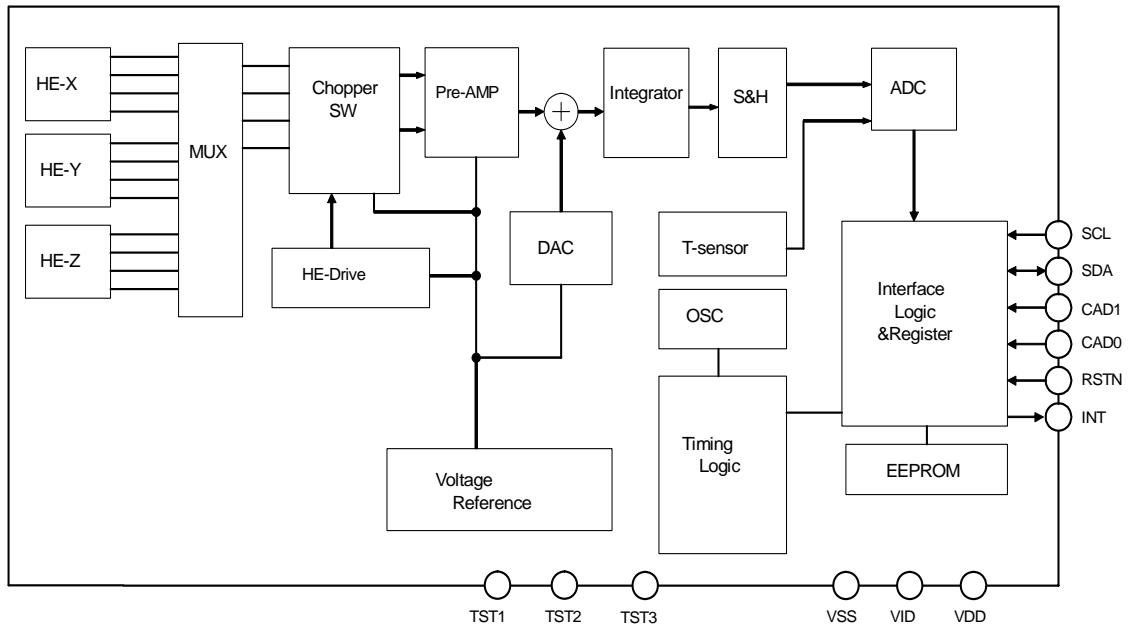

4.2. Block Function

Block	Function
HE-X, Y, Z	High sensitivity sensors included in the package
MUX	Multiplexer for selecting one axis from the 3-axis magnetic sensor
Chopper SW	Performs chopping.
HE-Drive	Magnetic sensor drive circuit for constant-current driving of sensor
Pre-AMP	Variable-gain differential amplifier used to amplify a magnetic sensor signal and to adjust sensitivity. Gain setting: 26.8dB min., increased in 0.4dB/step, 16 steps (4 bits)
DAC	DAC for offset voltage compensation. Resolution: 8 bits
Integrator	Integrates and amplifies the Pre-AMP output signal.
S&H	Sample-and-hold circuit
ADC	Performs analog-to-digital conversion for the signal of each sensor. Resolution: 8 bits
T-sensor	Temperature sensor: Outputs the voltage proportional to the temperature.
OSC	Built-in oscillator Automatically oscillates the operation clock in the sensor measurement mode.
Interface Logic & Register	Exchanges data with the external CPU. I ² C bus interface using two pins, namely, SCL and SDA. Using two pins of CAD0 and CAD1, lower 2-bit of slave address can be specified. Completion of sensor signal measurement is posted to the external CPU via INT pin. The low-voltage specification can be supported by applying 1.85V to the VID pin.
Timing Logic	Generates a timing signal required for internal operation based on the OSC generated clock.
EEPROM	Nonvolatile memory. Stores initial adjustment values of each sensor at the time of shipment from AKM. The I ² C bus interface is supported. Accessible through the two pins of SCL and SDA. Do not write to the EEPROM in ordinary use.

4.3. Pin Function

No.	Pin name	I/O	Power supply system	Type	Function
1	CAD0	I	VID	CMOS	Slave address 0 input pin
2	CAD1	I	VID	CMOS	Slave address 1 input pin
3	VID	-		POWER	Digital interface positive power supply pin. This pin is a positive power supply pin for the digital interface block. By connecting this pin to a 1.85V power supply, the low-voltage specification digital interface can be connected.
4	SDA	I/O	VID	CMOS	Control data input/output pin Input: Schmidt trigger, Output: Open drain
5	SCL	I	VID	CMOS	Control data clock input pin Input: Schmidt trigger
6	TST1	I/O	-	Analog	Test pin In usual use, eliminate unnecessary wiring, separate this pin from other test pins, and keep this pin electrically nonconnected.
7	INT	O	VID	CMOS	Interrupt signal output pin This pin is used to post the measurement completion to the external CPU. Refer to 6.3.
8	RSTN	I	VID	CMOS	Reset pin This pin resets all the register values when "L" is applied. After turning the power on, be sure to apply "L".
9	NC1	-	-	-	Nonconnected pin In usual use, eliminate unnecessary wiring, separate this pin from other test pins, and keep this pin electrically nonconnected.
10	TST2	I/O	-	Analog	Test pin In usual use, eliminate unnecessary wiring, separate this pin from other test pins, and keep this pin electrically nonconnected.
11	TST3	I/O	-	Analog	
12	NC2	-	-	-	Nonconnected pin In usual use, eliminate unnecessary wiring, separate this pin from other test pins, and keep this pin electrically nonconnected.
13	NC3	-	-	-	
14	NC4	-	-	-	
15	VDD	-		POWER	Power supply pin
16	VSS	-		POWER	Ground pin

5. Overall Characteristics

5.1. Absolute Maximum Ratings

VSS=0V

Parameter	Symbol	Min.	Max.	Unit
Power supply voltage (VDD, VID)	V+	-0.3	+6.5	V
Input voltage	VIN	-0.3	(V+)+0.3	V
Input current	IIN	-	±10	mA
Storage temperature	TST	-40	+85	°C

Note If the device is used in conditions exceeding these values, the device may be destroyed. Normal operations and EEPROM data are not guaranteed in such exceeding conditions.

5.2. Recommended Operating Conditions

VSS=0V

Parameter	Remark	Symbol	Min.	Typ.	Max.	Unit
Operating temperature		Ta	-30		+85	°C
Power supply voltage	VDD pin voltage	VDD	2.5	3.0	3.6	V
	VID pin voltage	VID	1.70	1.85	VDD	V

Note When turning on/off the power, turn on/off VDD and VID at the same time. .

5.3. Electrical Characteristics

The following conditions apply unless otherwise noted:

VDD=2.5V to 3.6V, VID=1.7V to VDD, Temperature range=-30°C to 85°C

5.3.1. DC Characteristics

Parameter	Symbol	Pin	Condition	Min.	Typ.	Max.	Unit
High level input voltage 1	VIH1	SCL SDA		70% VID			V
Low level input voltage 1	VIL1	CAD0 CAD1				30% VID	V
High level input voltage 2	VIH2	RSTN		80% VID			V
Low level input voltage 2	VIL2					20% VID	V
Input current (Note 1)	IIN	SCL SDA CAD0 CAD1 RSTN	Vin=VSS or VID	-10		+10	μA
Hysteresis input voltage (Note 2)	VHS	SCL SDA	VID≥2V	5% VID			V
			VID<2V	10% VID			V
High level output voltage 1	VOH1	INT	IOH=-200μA (Note 5)	90% VID			V
Low level output voltage 1	VOL1		IOL=+200μA (Note 5)			0.4	V
Low level output voltage 2 (Note 3)(Note 4)	VOL2	SDA	IOL=3mA VID≥2V			0.4	V
			IOL=3mA VID<2V			20% VID	V
Current consumption	IDD1		In power-down mode		0.2	5	μA
	IDD2		When magnetic sensor is driven		6.8	10.2	mA
	IDD3		Average when reading with 100ms		0.8	1.2	mA

(Note 1) Maximum input pin capacitance: 10pF (reference value for design)

(Note 2) Applied to the SCL pin and SDA pin (Schmitt trigger input) (reference value for design)

(Note 3) Maximum load capacitance: 400pF (capacitive load of each bus line applied to the I²C bus interface)

(Note 4) Output is open-drain output. Connect a pull-up resistor externally.

(Note 5) Load capacitance: 20pF

5.3.2. EEPROM Characteristics

Parameter	Min.	Max.	Unit
EEPROM erase/write cycles	1000		Cycles
EEPROM data retention	10 (85°C)		Years

* For write operation, VDD of 2.9V or more is required.

5.3.3. Analog Circuit Characteristics

Parameter	Symbol	Condition	Min.	Typ.	Max.	Unit
RSTN rise timing	TRS	From rising edge of power source (VDD, VID) until RSTN rising edge	100			ns
Time for measurement	TSM	Sum of Ttm+Thm (Refer to 6.2.2)	10.0	12.6	15.1	ms
ADC resolution	ASR			8		bit
DAC resolution	DRS			8		bit
DAC step width	DST	VDD=3.0V	124	156	187	μV
DAC accuracy	DAQ	VDD=3.0V			±1/8	LSB
Pre-AMP gain setting range		VDD=3.0V				
Lower limit	HASL	Gain setting register: 0H	26.3	26.8	27.3	dB
Upper limit	HASH	Gain setting register: FH (Note 6)	32.3	32.8	33.3	dB
Pre-AMP gain step width	AGS		0.25	0.4	0.55	dB
Temperature sensor measurement range	TOP		-30		85	°C
Temperature sensor output code	TOC	VDD=3.0V, Tc=35°C	71H	78H	7FH	code
Temperature sensor sensitivity	TSE	VDD=3.0V (Note 7)	-1.4	-1.6	-1.8	LSB/°C
Magnetic sensor sensitivity (Note 8)	BSE	VDD=2.5V Tc=25°C B=±300mT, Differential signal HXGA=HYGA=07H, HZGA=0AH	420	600	780	LSB

(Note 6) Gain setting register of each axis of magnetic sensor. HXGA, HYGA, HZGA. (Refer to 8.3.6.)

(Note 7) Reference value for design

(Note 8) Set the data of EHXGA, EHYGA, EZHGA into HXGA, HYGA, HZGA respectively. The adjustment value of the pre-AMP gain that becomes 1μT/1LSB is written in low 4bit of EHXGA, EHYGA, and EZHGA. Higher 4bit of HXGA, HYGA, and HZGA is disregarded even if written. Please copy 8bit data read from EHXGA, EHYGA, and EZHGA to HXGA, HYGA, and HZGA as it is.

5.4. Detailed Timing

5.4.1. Various Timing

Parameter	Symbol	Condition	Min.	Typ.	Max.	Unit
Wait time before mode setting	Twat		100			μs
RSTN Pulse Width	Trnw		100			ns
EEPROM access mode turn on time				300		μs
EEPROM programming time	Twr		10			ms

5.4.2. I²C Bus Interface

(1) Standard mode at $1.7V \leq VID \leq VDD$

Symbol	Parameter	Min.	Typ.	Max.	Unit
fSCL	SCL clock frequency			100	kHz
tHIGH	SCL clock "High" time	4.0			μs
tLOW	SCL clock "Low" time	4.7			μs
tR	SDA and SCL rise time			1.0	μs
tF	SDA and SCL fall time			0.3	μs
tHD:STA	Start Condition hold time	4.0			μs
tSU:STA	Start Condition setup time	4.7			μs
tHD:DAT	SDA hold time (vs. SCL falling edge)	0			μs
tSU:DAT	SDA setup time (vs. SCL rising edge)	250			ns
tSU:STO	Stop Condition setup time	4.0			μs
tBUF	Bus free time	4.7			μs

(2) Fast mode at $1.7V \leq VID \leq VDD$

Symbol	Parameter	Min.	Typ.	Max.	Unit
fSCL	SCL clock frequency			400	kHz
tHIGH	SCL clock "High" time	0.6			μs
tLOW	SCL clock "Low" time	1.3			μs
tR	SDA and SCL rise time			0.3	μs
tF	SDA and SCL fall time			0.3	μs
tHD:STA	Start Condition hold time	0.6			μs
tSU:STA	Start Condition setup time	0.6			μs
tHD:DAT	SDA hold time (vs. SCL falling edge)	0			μs
tSU:DAT	SDA setup time (vs. SCL rising edge)	100			ns
tSU:STO	Stop Condition setup time	0.6			μs
tBUF	Bus free time	1.3			μs
tSP	Noise suppression pulse width			50	ns

[I²C bus interface timing]

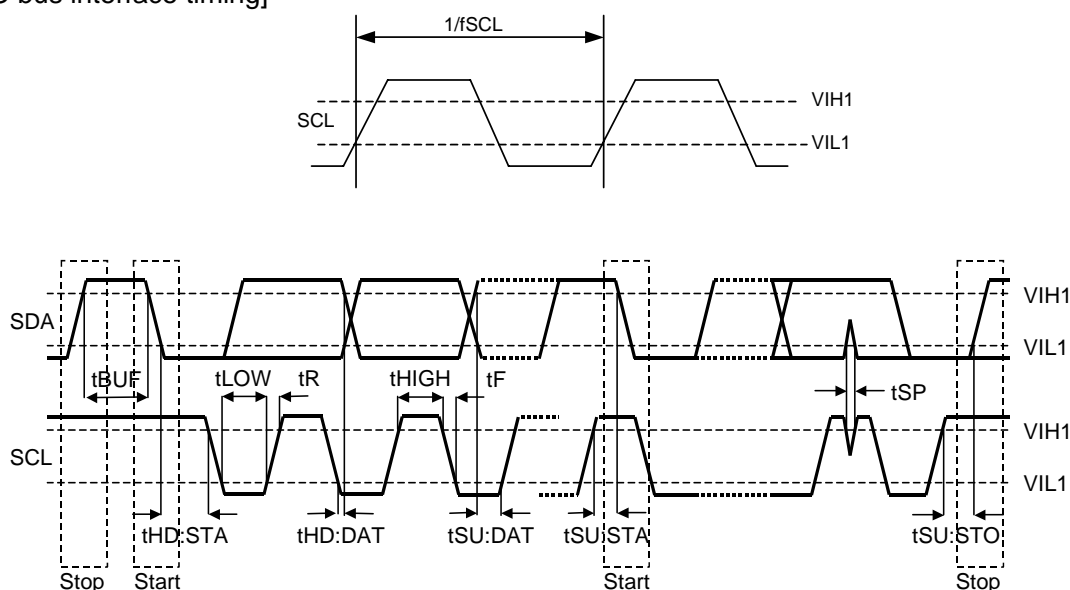

6. Functional Explanation

6.1. Operation Modes

AK8973 has following three operation modes:

- (1) Power-down mode
- (2) Sensor measurement mode
- (3) EEPROM access mode

By setting MS1 register MODE[1:0] bits, the operation set for each mode is started. A transition from one mode to another is shown below.

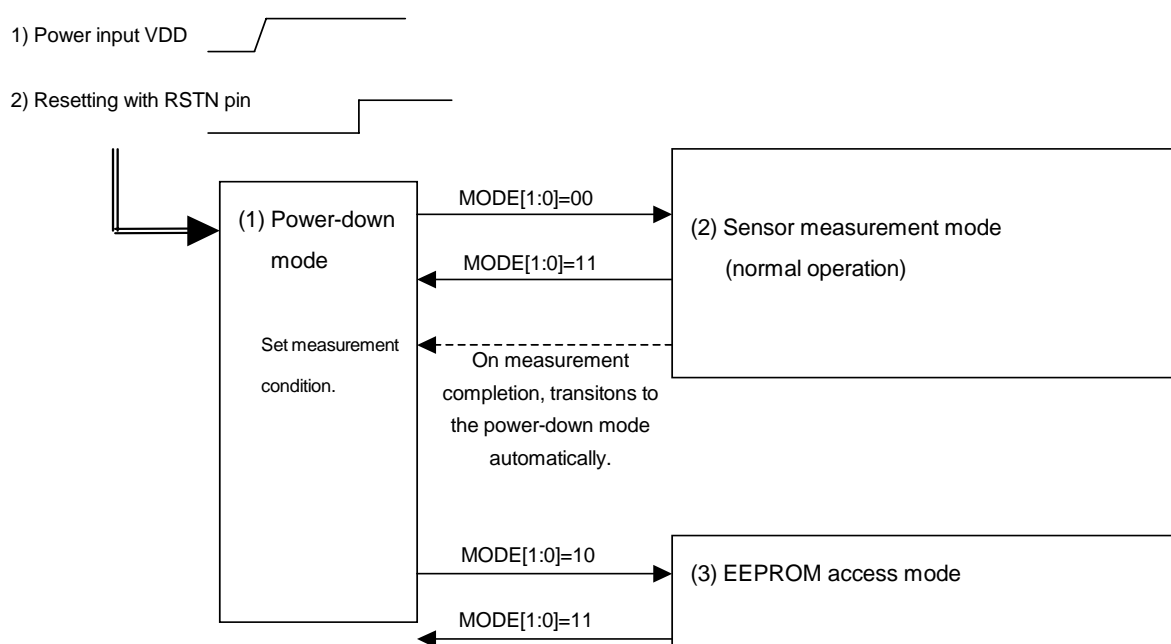

After turning on the power, perform a reset operation by applying "L" to RSTN pin. Then AK8973 is set to power-down mode.

A transition to mode (2) or (3) can be made only from power-down mode. A transition to a mode (2) or (3) must be made through the power-down mode. To make the mode transition, write the setting data into the MODE[1:0] shown in the transition diagram. After power-down mode is set, at least 100 μ s(T_{wait}) is needed before setting another mode.

Be sure to write a measurement condition for sensor measurement mode during the power-down mode. Write-only registers MS1 and read-only registers can be accessed in any of the modes above.

6.2. Description of Each Operation Mode

6.2.1. Power-down Mode

Power to all internal circuits is turned off.

During power-down mode, measurement conditions for sensor measurement mode can be set by setting adequate values to the registers.

The measurement conditions set in the registers are reset only by applying "L" signal to RSTN pin, and not by a mode transition.

6.2.2. Sensor Measurement Mode

Measurement is made with the sequence below. When the measurement is completed, it transits to power-down mode automatically.

<Timing Chart>

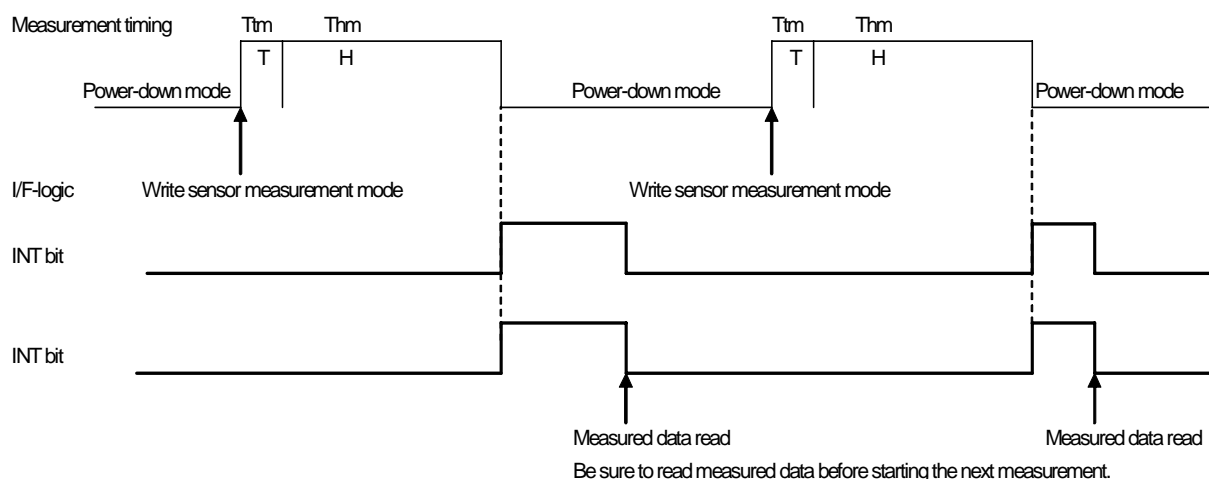

T_{tm}: Temperature sensor measurement period, T_{hm}: Magnetic sensor measurement period

TSM: T_{tm}+T_{hm}=12.56ms typ.

<Detailed Description>

When sensor measurement mode (MODE[1:0]="00") is set to register at power-down mode, AK8973 starts measurement operation. First, temperature sensor and 3-axis magnetic sensor are measured in sequence, automatically. Then, the measured data are stored in the following registers. Finally, AK8973 automatically transits to power-down mode.

Temperature sensor output result	Register	TMPS[7:0]
Magnetic sensor output result	Register	H1X[7:0], H1Y[7:0], H1Z[7:0]

When AK8973 returns to power-down mode, INT pin is driven to "H" to notify the external CPU that the measurements have been finished. INT bit is placed in the same state.

When sensor output results are read, INT pin is driven to "L". For the fall timing of INT pin, refer to "6.3. Interrupt Function based on INT Pin". On the falling edge of INT pin, INT bit also returns to "0".

When the external CPU confirmed that INT pin is driven to "H" or INT bit is set to "1", it should recognize that the sensor measurements are completed, and then read the mentioned 4-byte data of sensor output results.

<Note>

To execute the sensor measurement mode, INT pin must be "L" or INT bit must be "0". Before executing this pattern, check that INT pin is "L" or INT bit is "0", or drive INT pin to "L" by performing data register read operation as dummy. An attempt to set the sensor measurement mode when the INT pin is high is ignored. Also when the transition of power-down mode is set to the sensor measurement mode or EEPROM access mode, the contents of magnetic sensor output results of H1X[7:0], H1Y[7:0], and H1Z[7:0] are reset.

6.2.3. EEPROM Mode

This mode is used to access the EEPROM.

In ordinary use, read operation is needed, but write operation must not be performed.

To the EEPROM, the correction values of sensors are written before shipment from AKM. If these correction values are lost, AK8973 cannot perform operations and measurements normally.

For details, refer to "9. EEPROM".

6.3. Interrupt Function based on INT Pin

AK8973 has an interrupt function for notifying the external CPU of completion of sensor signal measurement by transition of INT pin from "L" to "H".

INT pin returns to "L" when any of the registers storing temperature or magnetic sensor output result is read.

On the falling edge of INT pin, INT bit also returns to "0".

In case of current address read, whether any of the registers mentioned above is read is checked. If any of them is read, INT pin returns to "L" at the timing shown below.

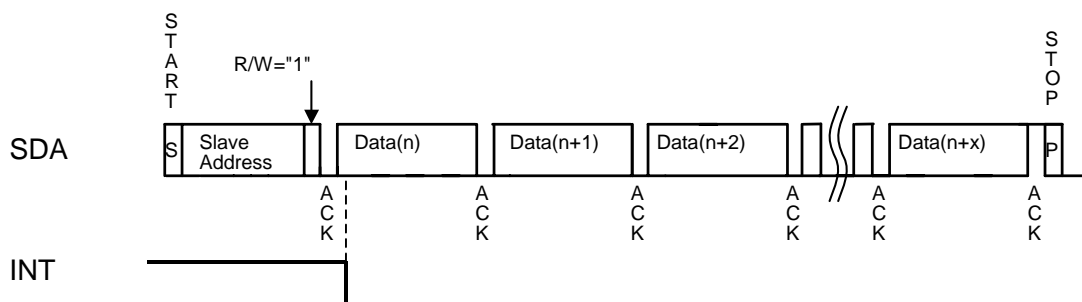

In case of random read, if the specified address is any of the registers mentioned above, INT pin returns to "L" at the timing shown below.

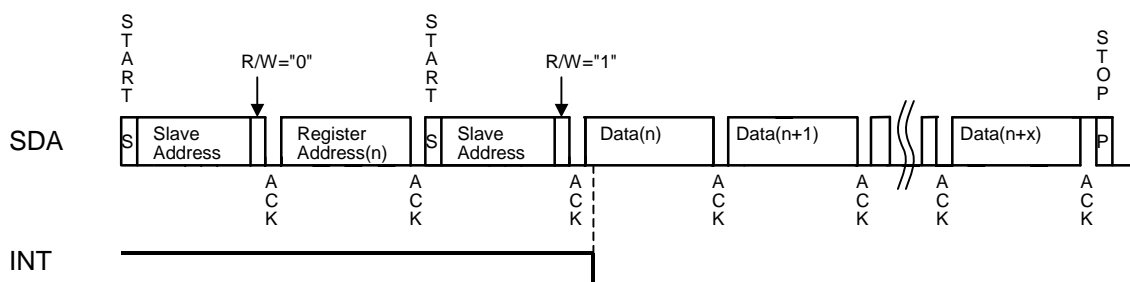

7. Serial Interface

The I²C bus interface of AK8973 supports the standard mode (100kHz max.) and the Fast mode (400kHz max.).

Both modes can be operable in $1.7V \leq VID \leq VDD$.

7.1. Data Transfer

To access the AK8973 on the bus, generate a start condition first.

Next, transmit a one-byte slave address including a device address. At this time, AK8973 compares the slave address with its own address. If these addresses match, AK8973 generates an acknowledgement, and then executes READ or WRITE instruction. At the end of instruction execution, generate a stop condition.

7.1.1. Change of Data

A change of data on the SDA line must be made during "Low" period of the clock on the SCL line. When the clock signal on the SCL line is "High", the state of the SDA line must be stable. (Data on the SDA line can be changed only when the clock signal on the SCL line is "Low".)

During the SCL line is "High", the state of data on the SDA line is changed only when a start condition or a stop condition is generated.

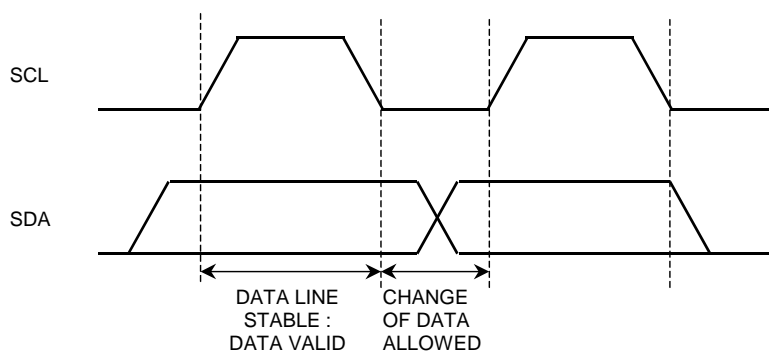

Fig. 01 Data Change

7.1.2. Start/Stop Condition

If the SDA line is driven to "Low" from "High" when the SCL line is "High", a start condition is generated. Any instruction starts with a start condition.

If the SDA line is driven to "High" from "Low" when the SCL line is "High", a stop condition is generated. Any instruction stops with a stop condition.

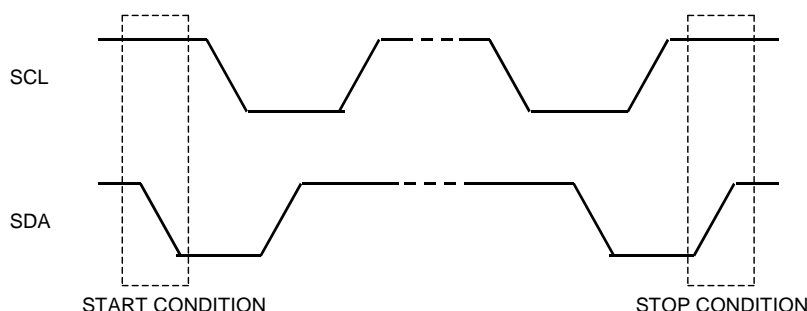

Fig. 02 START and STOP conditions

7.1.3. Acknowledge

The IC that is transmitting data releases the SDA line (in the "High" state) after sending 1-byte data. The IC that receives the data drives the SDA line to "Low" on the next clock pulse. This operation is referred to as acknowledge. With this operation, whether data has been transferred successfully can be checked. AK8973 generates an acknowledge after reception of a start condition and slave address. When a WRITE instruction is executed, AK8973 generates an acknowledge after every byte is received. When a READ instruction is executed, AK8973 generates an acknowledge then transfers the data stored at the specified address. Next, AK8973 releases the SDA line then monitors the SDA line. If a master IC generates an acknowledge instead of a stop condition, AK8973 transmits the 8bit data stored at the next address. If no acknowledge is generated, AK8973 stops data transmission.

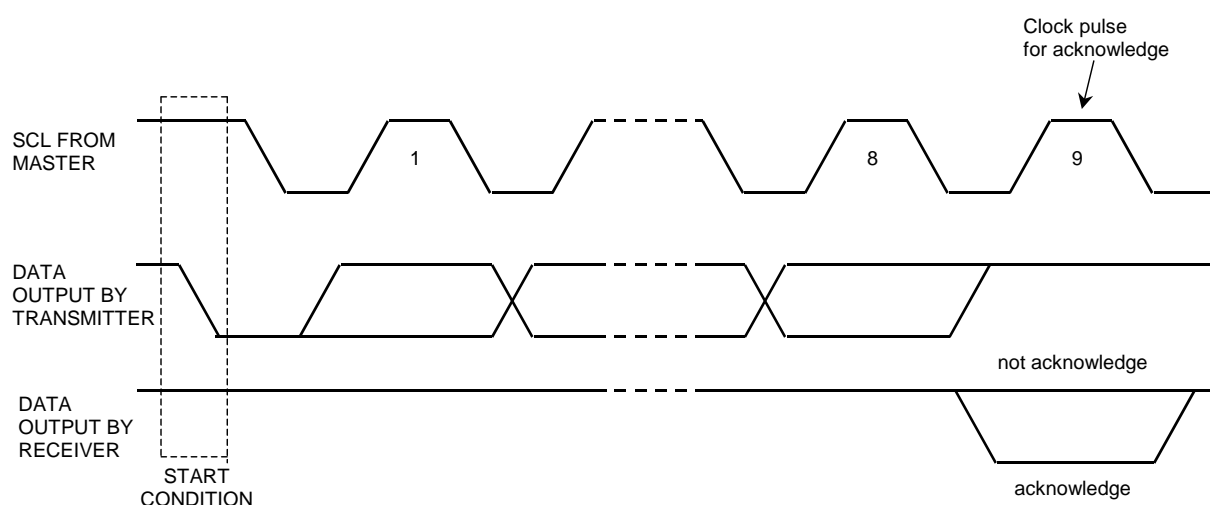

Fig. 03 Generation of Acknowledge

7.1.4. Slave Address

The first byte including a slave address is transmitted after a start condition, and an IC to be accessed is selected from the ICs on the bus according to the slave address. A slave address of AK8973 consists of 7 bits. The most significant 5 bits are fixed to "00111". The next 2 bits are address bits used to select an IC to be accessed, and are set by the CAD1-0 pins. When a slave address is transferred, the IC whose device address matches the transferred slave address generates an acknowledge then executes an instruction. The 8th bit (least significant bit) of the first byte is a R/W bit. When the R/W bit is set to "1", READ instruction is executed. When the R/W bit is set to "0", WRITE instruction is executed.

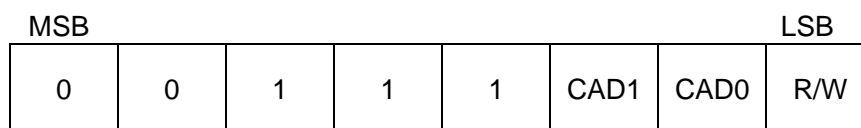

Fig. 04 Slave Address

7.2. WRITE Instruction

When the R/W bit is set to "0", AK8973 performs write operation.

In write operation, AK8973 generates an acknowledge after receiving a start condition and the first byte (slave address) then receives the second byte. The second byte is used to specify the address of an internal control register and is based on the MSB-first configuration.

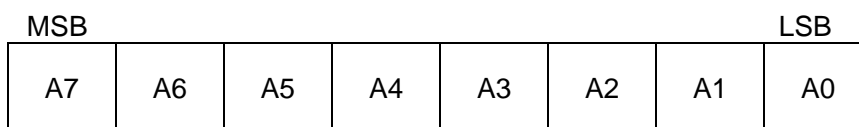

Fig. 05 Register Address

After receiving the second byte (register address), AK8973 generates an acknowledge then receives the third byte.

The third byte and after represent control data. Control data consists of 8 bits and is based on the MSB-first configuration. AK8973 generates an acknowledge after every byte is received. Data transfer always stops with a stop condition generated by the master.

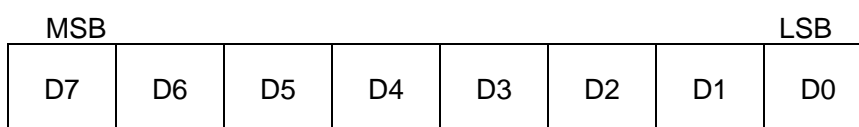

Fig. 06 Control Data

AK8973 can write multiple bytes of data at a time.

After reception of the third byte (control data), AK8973 generates an acknowledge then receives the next data. If additional data is received instead of a stop condition after receiving one byte of data, the address counter inside the LSI chip is automatically incremented and the data is written at the next address.

If the writing of data starts at address "E0H", the write address changes from "E0H, E1H through E5H, E6H". When "E6H" is exceeded, the internal address counter rolls over, and the following data is written in sequentially starting at address "E0H" again.

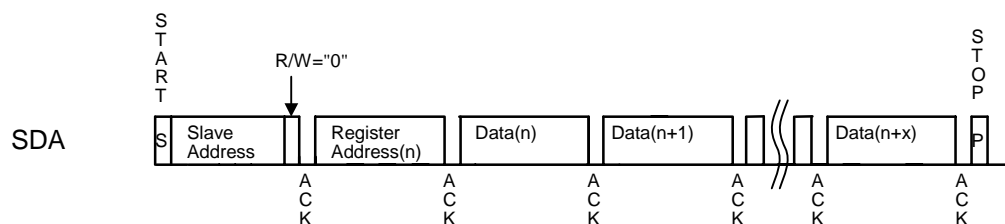

Fig. 07 WRITE Operation

7.3. READ Instruction

When the R/W bit is set to "1", AK8973 performs read operation.

If a master IC generates an acknowledge instead of a stop condition after AK8973 transfers the data at a specified address, the data at the next address can be read.

If the reading of data starts from "C0H, C1H through C3H, C4H" or "E0H, E1H through E5H, E6H", and additional data is read after reading, the internal address counter rolls over and the data at "C0H" or "E0H" is read again.

AK8973 supports current address read and random read.

7.3.1. Current Address READ

AK8973 has an address counter inside the LSI chip. In current address read operation, the data at an address specified by this counter is read.

The internal address counter holds the next address of the most recently accessed address.

For example, if the address most recently accessed (for READ instruction) is address "n", and a current address read operation is attempted, the data at address "n+1" is read.

In current address read operation, AK8973 generates an acknowledge after receiving a slave address for the READ instruction (R/W bit="1"). Next, AK8973 transfers the data specified by the internal address counter starting with the next clock pulse, then increments the internal counter by one. If the master IC generates a stop condition instead of an acknowledge after AK8973 transmits one byte of data, the read operation stops.

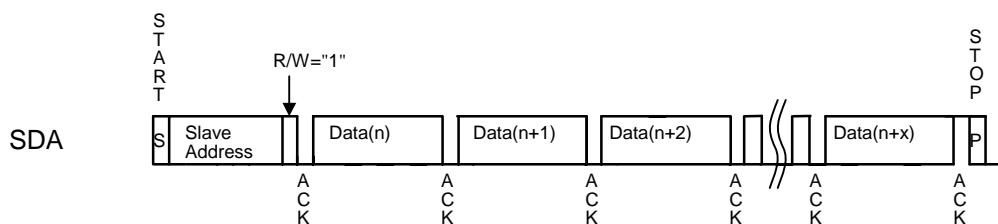

Fig. 08 CURRENT ADDRESS READ

7.3.2. Random READ

By random read operation, data at an arbitrary address can be read.

Random read operation requires to execute WRITE instruction as dummy before a slave address for the READ instruction (R/W bit="1") is transmitted. In random read operation, a start condition is first generated then a slave address for the WRITE instruction (R/W bit="0") and a read address are transmitted sequentially.

After AK8973 generates an acknowledge in response to this address transmission, a start condition and a slave address for the READ instruction (R/W bit="1") are generated again. AK8973 generates an acknowledge in response to this slave address transmission. Next, AK8973 transfers the data at the specified address then increments the internal address counter by one. If the master IC generates a stop condition instead of an acknowledge after data is transferred, the read operation stops.

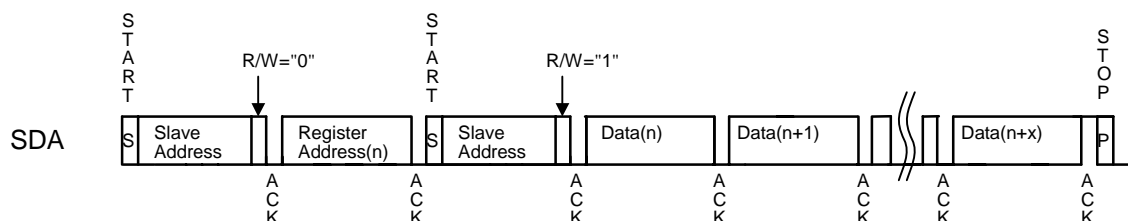

Fig. 09 RANDOM READ

8. Registers

8.1. Description of Registers

AK8973 has registers of 13 addresses as indicated in Table 1. Every address consists of 8 bits data. Data is transferred to or received from the external CPU via the serial interface described previously.

Name	Address	READ/ WRITE	Description	Explanation
ST	C0H	READ	Status register	Interrupt EEPROM write enabled/disabled
TMPS	C1H	READ	Temperature sensor data register	Temperature sensor data read
H1X	C2H	READ	Magnetic sensor data register	X-axis data read
H1Y	C3H			Y-axis data read
H1Z	C4H			Z-axis data read
MS1	E0H	READ/ WRITE	Mode setting register	Operation mode setting EEPROM write enable/disable setting
HXDA	E1H	READ/ WRITE	Magnetic sensor X-axis DAC setting register	X-axis offset DAC setting value
HYDA	E2H	READ/ WRITE	Magnetic sensor Y-axis DAC setting register	Y-axis offset DAC setting value
HZDA	E3H	READ/ WRITE	Magnetic sensor Z-axis DAC setting register	Z-axis offset DAC setting value
HXGA	E4H	READ/ WRITE	Magnetic sensor X-axis gain setting register	X-axis AMP gain setting value
HYGA	E5H	READ/ WRITE	Magnetic sensor Y-axis gain setting register	Y-axis AMP gain setting value
HZGA	E6H	READ/ WRITE	Magnetic sensor Z-axis gain setting register	Z-axis AMP gain setting value
TS1	5DH	READ/ WRITE	Test mode setting register	Not to be used by the user. Used for testing before shipment

Table 1

8.2. Register Map

Addr	Register Name	D7	D6	D5	D4	D3	D2	D1	D0
Read-only Register									
C0H	ST	0	0	0	0	0	0	WEN	INT
C1H	TMPS	TMPS7	TMPS6	TMPS5	TMPS4	TMPS3	TMPS2	TMPS1	TMPS0
C2H	H1X	H1X7	H1X6	H1X5	H1X4	H1X3	H1X2	H1X1	H1X0
C3H	H1Y	H1Y7	H1Y6	H1Y5	H1Y4	H1Y3	H1Y2	H1Y1	H1Y0
C4H	H1Z	H1Z7	H1Z6	H1Z5	H1Z4	H1Z3	H1Z2	H1Z1	H1Z0
Write/read register									
E0H	MS1	WEN4	WEN3	WEN2	WEN1	WEN0	0	MODE1	MODE0
E1H	HXDA	HXDA7	HXDA6	HXDA5	HXDA4	HXDA3	HXDA2	HXDA1	HXDA0
E2H	HYDA	HYDA7	HYDA6	HYDA5	HYDA4	HYDA3	HYDA2	HYDA1	HYDA0
E3H	HZDA	HZDA7	HZDA6	HZDA5	HZDA4	HZDA3	HZDA2	HZDA1	HZDA0
E4H	HXGA	0	0	0	0	HXGA3	HXGA2	HXGA1	HXGA0
E5H	HYGA	0	0	0	0	HYGA3	HYGA2	HYGA1	HYGA0
E6H	HZGA	0	0	0	0	HZGA3	HZGA2	HZGA1	HZGA0
5DH	TS1	-	-	-	-	-	-	-	-

When the RSTN pin is driven to "L", all registers of AK8973 are initialized, resulting in power-down mode. During sensor measurement mode, only MS1 register can be written in. Do not write in the registers other than MS1.

TS1 is test mode setting addresses for testing before shipment. Do not use TS1. Otherwise, the operation error may result.

8.3. Detailed Description of Registers

8.3.1. ST: Status Register

Addr	Register name	D7	D6	D5	D4	D3	D2	D1	D0
Read-only register									
C0H	ST	0	0	0	0	0	0	WEN	INT
	Reset	0	0	0	0	0	0	0	0

INT: Interrupt flag bit

"0": Interrupt reset state

"1": Interrupt state

(This bit is valid only in sensor measurement mode (not valid in other modes).)

WEN: EEPROM write enabled/disabled state check bit

"0": Read mode

"1": Write mode

8.3.2. TMPS: Temperature Sensor Data Register

Addr	Register name	D7	D6	D5	D4	D3	D2	D1	D0
Read-only register									
C1H	TMPS	TMPS7	TMPS6	TMPS5	TMPS4	TMPS3	TMPS2	TMPS1	TMPS0
	Reset	0	0	0	0	0	0	0	0

TMPS[7:0]: Temperature sensor output data

Temperature sensor (T-Sensor) converted data 8 bits

TMPS code	Temperature [°C]
E0H	-30
D0H	-20
C0H	-10
B0H	0
A0H	10
90H	20
80H	30
70H	40
60H	50
50H	60
40H	70
30H	80
20H	90

Table 2

8.3.3. H1X, H1Y, H1Z: Sensor Data Register

Addr	Register name	D7	D6	D5	D4	D3	D2	D1	D0
Read-only register									
C2H	H1X	H1X7	H1X6	H1X5	H1X4	H1X3	H1X2	H1X1	H1X0
C3H	H1Y	H1Y7	H1Y6	H1Y5	H1Y4	H1Y3	H1Y2	H1Y1	H1Y0
C4H	H1Z	H1Z7	H1Z6	H1Z5	H1Z4	H1Z3	H1Z2	H1Z1	H1Z0
Reset		0	0	0	0	0	0	0	0

H1X/H1Y/H1Z: Magnetic sensor X-axis/Y-axis/Z-axis output result

H1X[7:0]: X-axis output result

H1Y[7:0]: Y-axis output result

H1Z[7:0]: Z-axis output result

Minimum value: 00H Maximum value: FFH

8.3.4. MS1: Mode Setting Register 1

Addr	Register name	D7	D6	D5	D4	D3	D2	D1	D0
Write/read register									
E0H	MS1	WEN4	WEN3	WEN2	WEN1	WEN0	0	MODE1	MODE0
Reset		0	0	0	0	0	0	1	1

MODE[1:0]: Operation mode setting

"00": Sensor measurement mode

"01": Setting prohibited

"10": EEPROM access mode

"11": Power-down mode

WEN[4:0]: Setting to enable/disable EEPROM data write

"10101": Write mode (write enabled)

Other than "10101": Read mode (write disabled)

8.3.5. HXDA, HYDA, HZDA: Magnetic Sensor DAC Setting Register

Addr	Register name	D7	D6	D5	D4	D3	D2	D1	D0
Write/read register									
E1H	HXDA	HXDA7	HXDA6	HXDA5	HXDA4	HXDA3	HXDA2	HXDA1	HXDA0
E2H	HYDA	HYDA7	HYDA6	HYDA5	HYDA4	HYDA3	HYDA2	HYDA1	HYDA0
E3H	HZDA	HZDA7	HZDA6	HZDA5	HZDA4	HZDA3	HZDA2	HZDA1	HZDA0
Reset		0	0	0	0	0	0	0	0

HXDA[7:0]: Magnetic sensor X-axis offset DAC setting

HYDA[7:0]: Magnetic sensor Y-axis offset DAC setting

HZDA[7:0]: Magnetic sensor Z-axis offset DAC setting

Setting	Set voltage [μ V] 156.25 μ V/step
FFH	+19843.75
FEH	+19687.50
:	:
81H	+156.25
80H	+0
00H	-0
01H	-156.25
:	:
7EH	-19687.50
7FH	-19843.75

Table 3

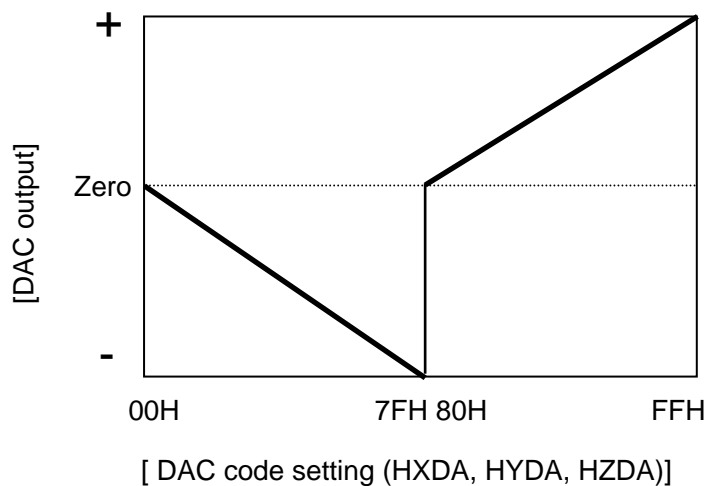

8.3.6. HXGA, HYGA, HZGA: Magnetic Sensor Gain Setting Register

Addr	Register name	D7	D6	D5	D4	D3	D2	D1	D0
Write/read register									
E4H	HXGA	0	0	0	0	HXGA3	HXGA2	HXGA1	HXGA0
E5H	HYGA	0	0	0	0	HYGA3	HYGA2	HYGA1	HYGA0
E6H	HZGA	0	0	0	0	HZGA3	HZGA2	HZGA1	HZGA0
Reset		0	0	0	0	0	0	0	0

HXGA[3:0]: Magnetic sensor X-axis gain setting

HYGA[3:0]: Magnetic sensor Y-axis gain setting

HZGA[3:0]: Magnetic sensor Z-axis gain setting

Gain setting=(26.8+0.4×N)dB N=0 to 15

Setting	Gain [dB]
0H	26.8
1H	27.2
2H	27.6
3H	28.0
4H	28.4
5H	28.8
6H	29.2
7H	29.6
8H	30.0
9H	30.4
AH	30.8
BH	31.2
CH	31.6
DH	32.0
EH	32.4
FH	32.8

Table 4

9. EEPROM

9.1. Outline of the Function

Caution

Never write in EEPROM.

Device-specific adjusted values are stored before shipment in AKM. Write operation is not needed in user operation. It may lose adjusted values. If these adjusted values are lost, AK8973 cannot operate normally.

AK8973 includes an EEPROM consisting of 7 words by 8 bits. Each word can be read and written independently.

Two interfaces, I²C bus standard mode (100kHz max.) and fast mode (400kHz max.), are supported.

Before reading from or writing in the EEPROM, be sure to write "10" into MODE[1:0] bit of register MS1 and set the operation mode to EEPROM access mode. By this setting, the circuits such as the reference voltage circuit needed for the EEPROM access mode are started up (start-up wait time: 300μs).

A high voltage required for write operation is generated inside the device.

The EEPROM can be read from or written in depending on the setting of the "EEPROM data write enable/disable setting" which is written in the WEN[4:0] bit of register MS1.

Operation	WEN[4:0] bit setting	Address section	Data section	Description
Read	Other than "10101"	A7-A0	ED7-ED0 (out)	EEPROM memory read
Write	"10101"	A7-A0	ED7-ED0 (in)	EEPROM memory write

Table 5

* WEN bit of ST register can be used to check if the current mode is the read mode or write mode.

When the EEPROM access mode is completed, set the MODE[1:0] to "11" for power-down, and then transit to another mode.

9.2. Operation Description

EEPROM read and write operations are controlled by SCL pin, SDA pin, CAD1 pin, CAD0 pin, and WEN[4:0] bit. The function of "data transfer" is the same as described in 7.1.

9.2.1. READ Instruction

Data can be read from the EEPROM by accessing an EEPROM address in the read mode (write disabled). AK8973 has two READ instructions of current address read and random read. To terminate READ operation, set MODE[1:0] of MS1 to "11" to transit to power-down mode.

9.2.1.1. Current Address READ

AK8973 has an address counter inside the LSI chip. In current address read operation, the data at an address specified by this counter is read.

The internal address counter holds the next address of the most recently accessed address.

If the address most recently accessed (for WRITE or READ instruction) is address "n", and a current address read operation is attempted, the data at address "n+1" is read.

For example, if read operations are performed in succession, data is read from 62H, 63H through 67H, 68H, 62H, and so on in this order.

In current address read operation, AK8973 generates an acknowledge after receiving a slave address for the READ instruction (R/W bit="1"). Next, AK8973 transfers the data specified by the internal address counter starting with the next clock pulse, then increments the internal counter by one. If the master IC generates a stop condition instead of an acknowledge after AK8973 transmits one byte of data, the read operation stops.

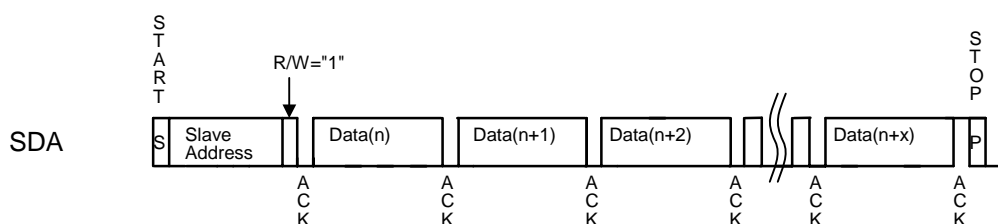

Fig. 10 CURRENT ADDRESS READ

9.2.1.2. Random READ

By random read operation, data at an arbitrary address can be read.

Random read operation requires to execute WRITE instruction as dummy before a slave address for the READ instruction (R/W bit="1") is transmitted. In random read operation, a start condition is first generated then a slave address for the WRITE instruction (R/W bit="0") and a read address are transmitted sequentially.

After AK8973 generates an acknowledge in response to this address transmission, a start condition and a slave address for the READ instruction (R/W bit="1") are generated again. AK8973 generates an acknowledge in response to this slave address transmission. Next, AK8973 transfers the data at the specified address then increments the internal address counter by one. If the master IC generates a stop condition instead of an acknowledge after data is transferred, the read operation stops.

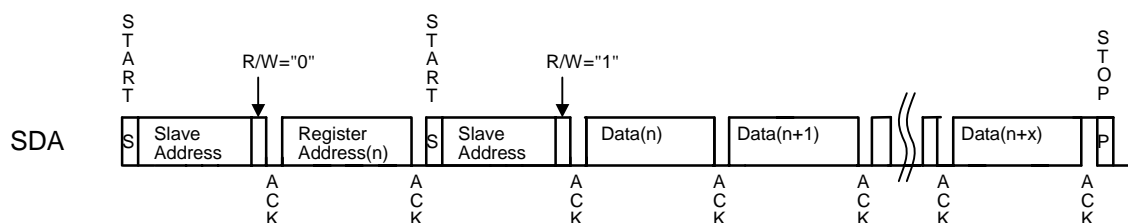

Fig. 11 RANDOM READ

9.2.2. WRITE Instruction

9.2.2.1. Byte-Write

Data is written at a specified address. A stop condition is required for every byte of data writing.

Input a start condition, slave address (R/W="0"), address, and data in this order.

AK8973 generates an acknowledge after receiving a slave address, after receiving an address, and after receiving data.

Upon reception of a stop condition, AK8973 starts an internal programming cycle.

During the internal programming cycle, avoid making accesses to any valid addresses of AK8973 for operations including read and write operations for registers.

To stop the WRITE instruction, set WEN[4:0] bits of the MS1 register to other than "10101" when the internal programming time or more has elapsed. If the programming time is insufficient, correct writing of the last data is not guaranteed.

In case that data is written in successively.

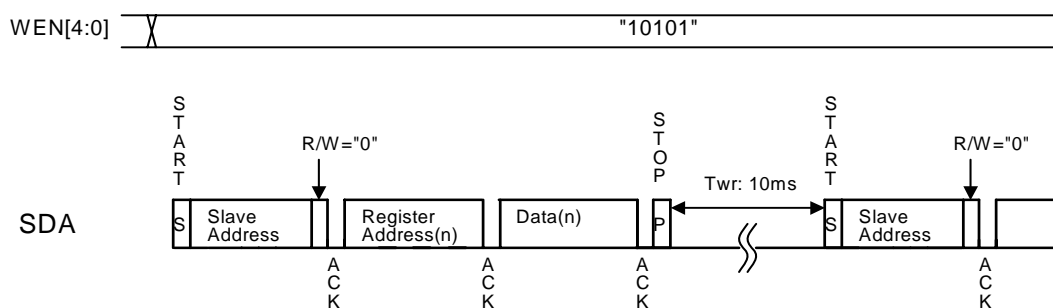

In case of stopping write operation.

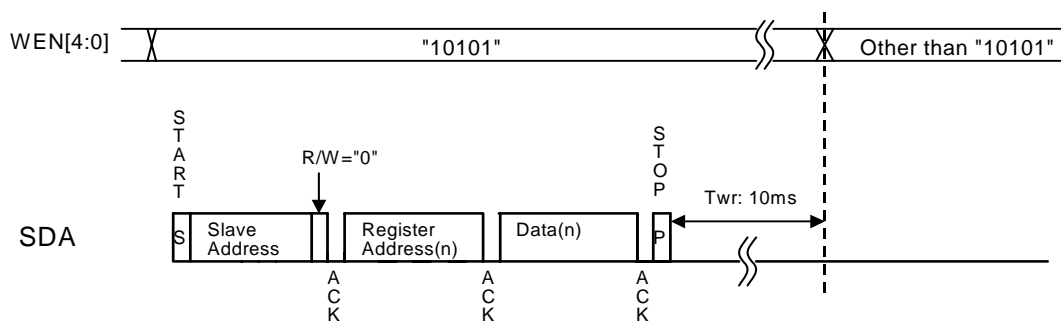

Fig. 12 Byte-write

9.3. Memory Map

Table 6 indicates the EEPROM memory map. There are eight addresses in total.

Do not rewrite any data written in the EEPROM.

Name	Address	Data		
	A7 to A0	Description	Number of bits	Factory-set value
ETS	62H	Offset adjustment for temperature sensor [5:0]	8	Individual adjustment value
EVIR	63H	VREF (EVIR[7:4]) & IREF (EVIR[3:0]) adjustment value	8	Individual adjustment value
EIHE	64H	HE drive power supply correction value [7:4] & OSC adjustment value [3:0]	8	Individual adjustment value
ETST	65H	For testing	8	Individual adjustment value
EHXGA	66H	Magnetic sensor X-axis gain adjustment value	8	Individual adjustment value
EHYGA	67H	Magnetic sensor Y-axis gain adjustment value	8	Individual adjustment value
EHZGA	68H	Magnetic sensor Z-axis gain adjustment value	8	Individual adjustment value
WRAL1	60H	Address for batch EEPROM write	-	-

Table 6

<ETS, EVIR, EIHE>

These data items are internally connected to registers of AK8973 to directly control adjustment values. Data other than ETS, EVIR, and EIHE is not directly connected to internal registers of AK8973.

<ETST>, <WRAL1>

Addresses for testing. Usually, do not access these addresses.

<EHXGA, EHYGA, EHZGA>

These addresses are used for magnetic sensor adjustment. These data items are read and set to HXGA, HYGA and HZGA registers respectively to adjust the sensitivity of each axis of the magnetic sensors.

At addresses other than the above addresses, the EEPROM circuit of AK8973 does not operate.

10. Example of Recommended External Connection

Pull up the bus of SDA pin to VID.

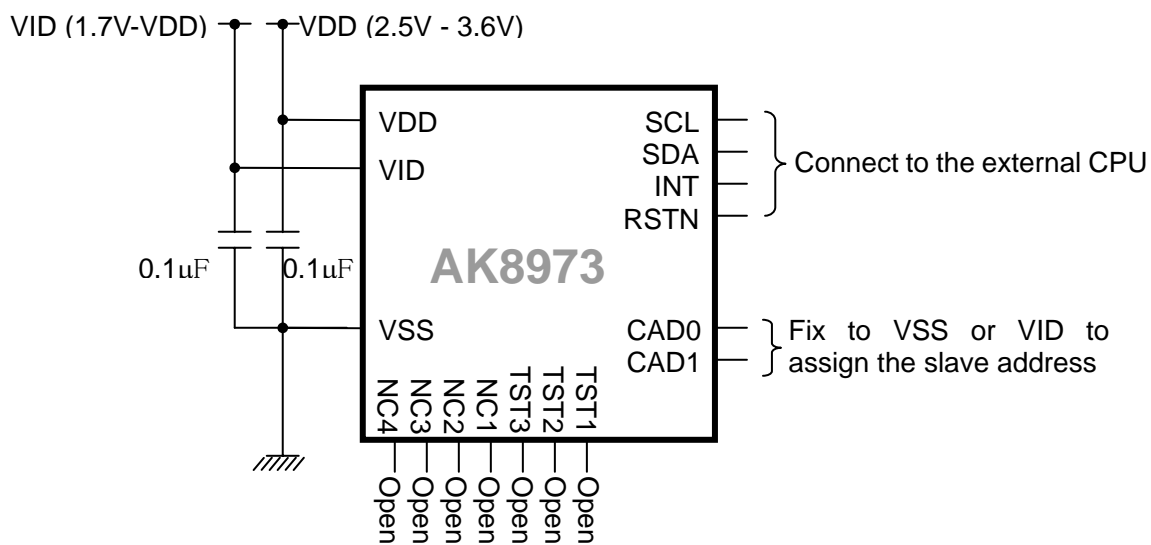
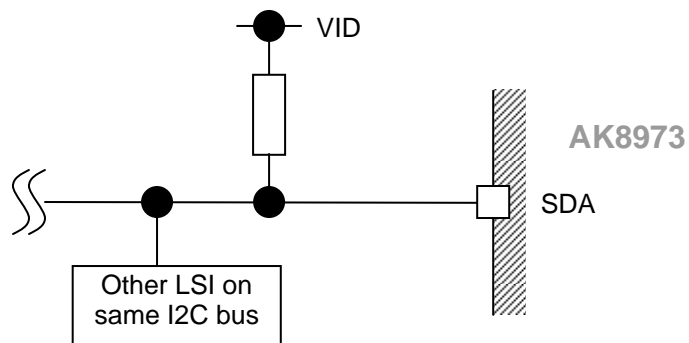

11. Package

11.1. Marking

- Company logo: AKM
- Product name: 8973
- Date code: X₁X₂X₃X₄
 - X₁ = Year
 - X₂X₃ = Week
 - X₄ = Lot

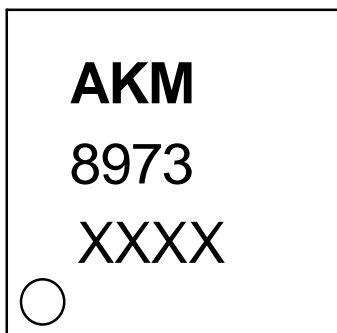

11.2. Pin Assignment

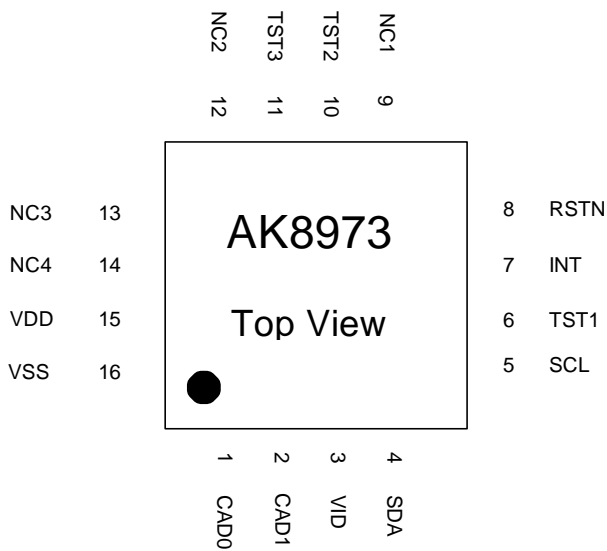

11.3. Outline Dimensions

[mm]

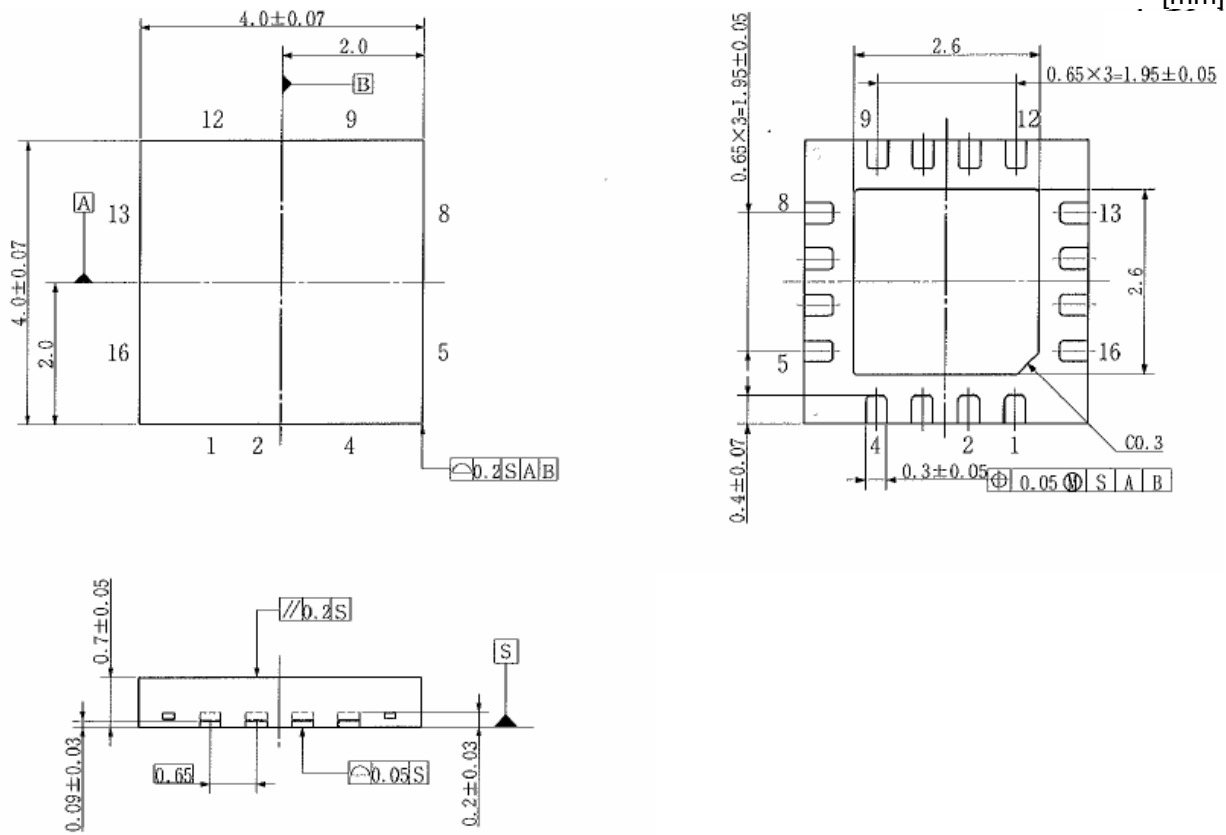

11.4. Recommended Foot Print Pattern

[mm]

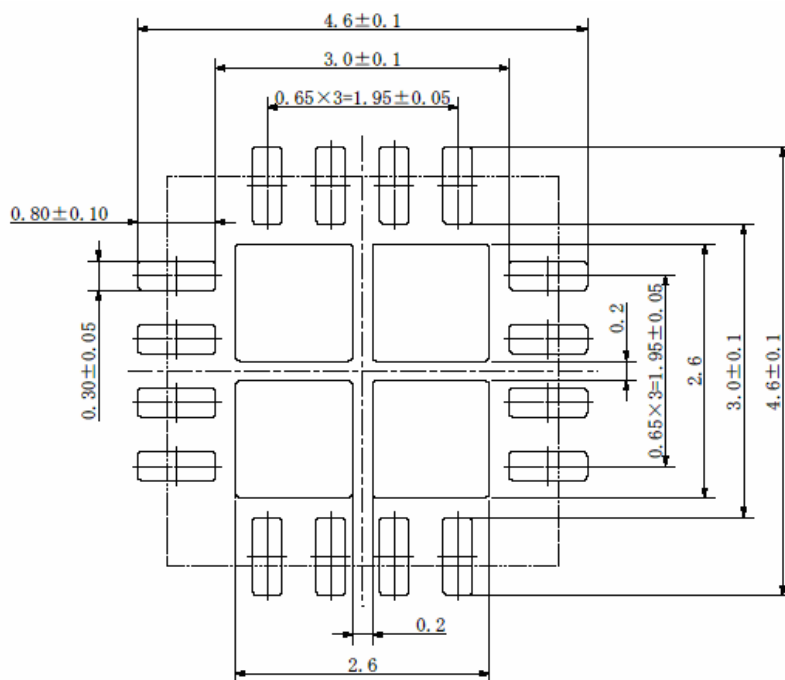

12. Relationship between the Magnetic Field and Output Code

The AD converter code increases as the magnetic flux density increases in the arrow directions.

On the Z-axis, the AD converter code increases as the magnetic flux density in the direction from the back of the package to the front face increases.

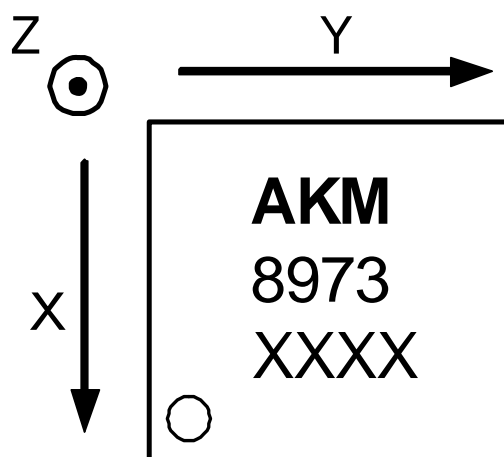

Top View

Important Notice

- These products and their specifications are subject to change without notice. Before considering any use or application, consult the Asahi Kasei Microsystems Co., Ltd. (AKM) sales office or authorized distributor concerning their current status.
- AKM assumes no liability for infringement of any patent, intellectual property, or other right in the application or use of any information contained herein.
- Any export of these products, or devices or systems containing them, may require an export license or other official approval under the law and regulations of the country of export pertaining to customs and tariffs, currency exchange, or strategic materials.
- AKM products are neither intended nor authorized for use as critical components in any safety, life support, or other hazard related device or system, and AKM assumes no responsibility relating to any such use, except with the express written consent of the Representative Director of AKM. As used here:
 - (a) A hazard related device or system is one designed or intended for life support or maintenance of safety or for applications in medicine, aerospace, nuclear energy, or other fields, in which its failure to function or perform may reasonably be expected to result in loss of life or in significant injury or damage to person or property.
 - (b) A critical component is one whose failure to function or perform may reasonably be expected to result, whether directly or indirectly, in the loss of the safety or effectiveness of the device or system containing it, and which must therefore meet very high standards of performance and reliability.
- It is the responsibility of the buyer or distributor of an AKM product who distributes, disposes of, or otherwise places the product with a third party to notify that party in advance of the above content and conditions, and the buyer or distributor agrees to assume any and all responsibility and liability for and hold AKM harmless from any and all claims arising from the use of said product in the absence of such notification.