

# Kingbright

## SOT-23 SURFACE MOUNT LED LAMP

Part Number: AM23SYC-F

Super Bright Yellow

### Features

- SOT-23 PACKAGE SURFACE MOUNT LED LAMP.
- LOW POWER CONSUMPTION.
- LONG LIFE - SOLID STATE RELIABILITY.
- PACKAGE: 2000PCS / REEL.
- MOISTURE SENSITIVITY LEVEL : LEVEL 3.
- RoHS COMPLIANT.

### Description

The Super Bright Yellow device is made with DH InGaAlP (on GaAs substrate) light emitting diode chip.

### Package Dimensions

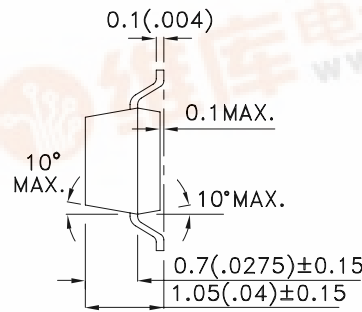
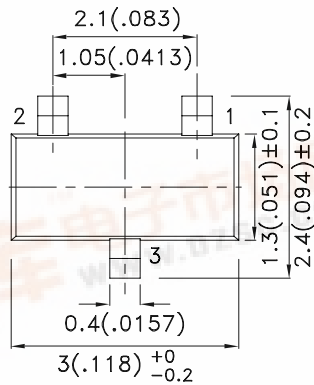

- 1 ANODE
- 2 N.C.
- 3 CATHODE

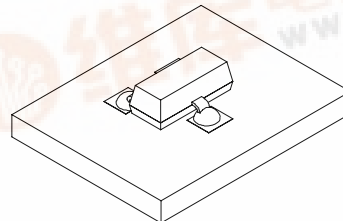

#### Notes:

1. All dimensions are in millimeters (inches).
2. Tolerance is  $\pm 0.25(0.01")$  unless otherwise noted.
3. Lead spacing is measured where the lead emerge from the package.
4. Specifications are subject to change without notice.
5. The device has a single mounting surface. The device must be mounted according to the specifications.



## Selection Guide

Part No.	Dice	Lens Type	Iv (mcd) [2] @ 20mA		Viewing Angle [1]
			Min.	Typ.	2θ1/2
AM23SYC-F	Super Bright Yellow (InGaAlP)	WATER CLEAR	50	150	140°

**Notes:**

1. θ1/2 is the angle from optical centerline where the luminous intensity is 1/2 the optical centerline value.
2. Luminous intensity/ luminous Flux: +/-15%.

## Electrical / Optical Characteristics at TA=25°C

Symbol	Parameter	Device	Typ.	Max.	Units	Test Conditions
$\lambda_{peak}$	Peak Wavelength	Super Bright Yellow	590		nm	I <sub>F</sub> =20mA
$\lambda_D$ [1]	Dominant Wavelength	Super Bright Yellow	588		nm	I <sub>F</sub> =20mA
$\Delta\lambda_{1/2}$	Spectral Line Half-width	Super Bright Yellow	28		nm	I <sub>F</sub> =20mA
C	Capacitance	Super Bright Yellow	25		pF	V <sub>F</sub> =0V;f=1MHz
V <sub>F</sub> [2]	Forward Voltage	Super Bright Yellow	2	2.5	V	I <sub>F</sub> =20mA
I <sub>R</sub>	Reverse Current	Super Bright Yellow		10	uA	V <sub>R</sub> =5V

**Notes:**

1. Wavelength: +/-1nm.
2. Forward Voltage: +/-0.1V.

## Absolute Maximum Ratings at TA=25°C

Parameter	Super Bright Yellow	Units
Power dissipation	75	mW
DC Forward Current	30	mA
Peak Forward Current [1]	150	mA
Reverse Voltage	5	V
Operating Temperature	-40°C To +85°C	
Storage Temperature	-40°C To +85°C	

**Note:**

1. 1/10 Duty Cycle, 0.1ms Pulse Width.

# Kingbright

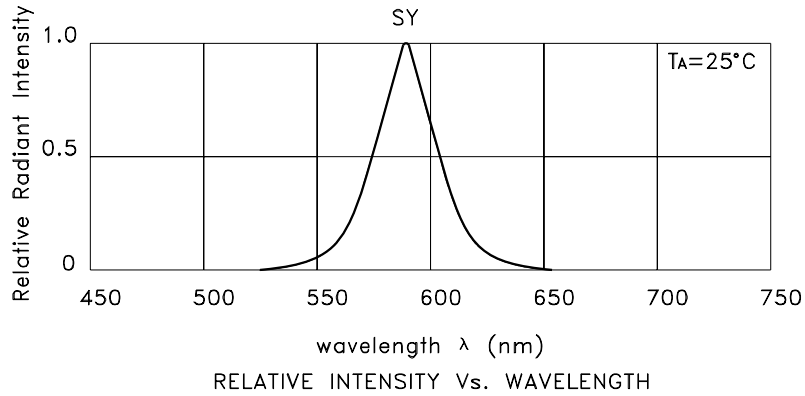

## Super Bright Yellow AM23SYC-F

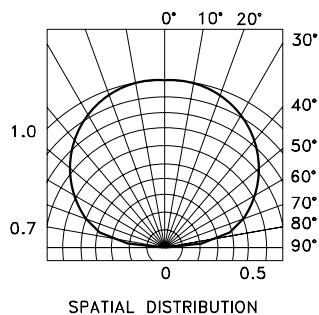
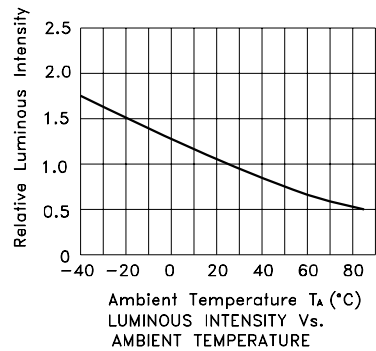
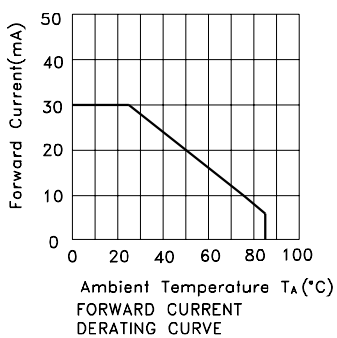
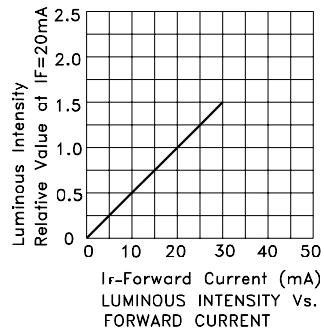
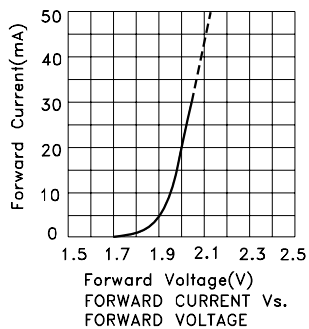

## AM23SYC-F

Reflow Soldering Profile For Lead-free SMT Process.

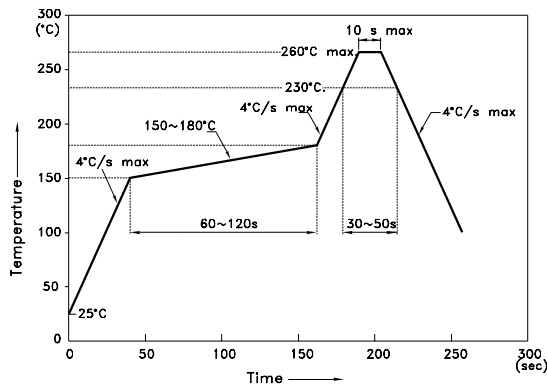

NOTES:

1. We recommend the reflow temperature 245°C(+/-5°C). The maximum soldering temperature should be limited to 260°C.
2. Don't cause stress to the epoxy resin while it is exposed to high temperature.
3. Number of reflow process shall be 2 times or less.

### Recommended Soldering Pattern (Units : mm; Tolerance: ± 0.1)

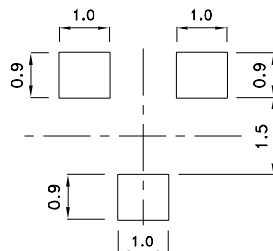

### Tape Specifications (Units : mm)

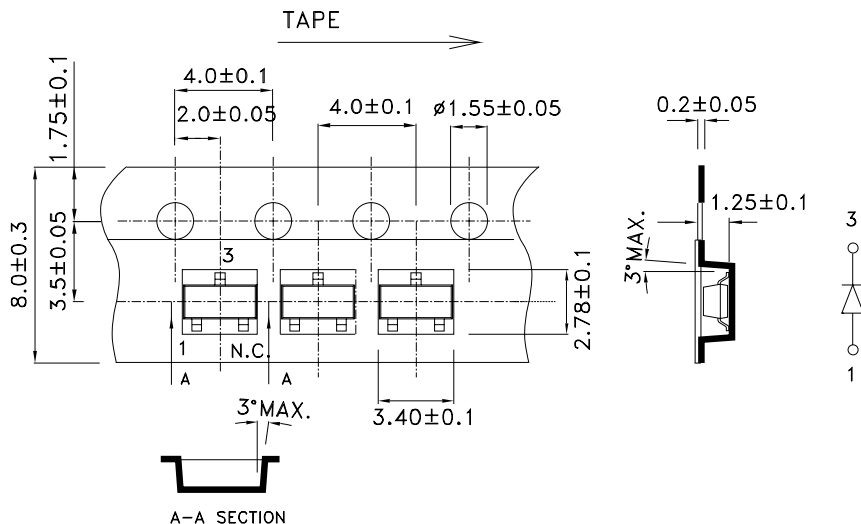

# Kingbright

## PACKING & LABEL SPECIFICATIONS

## AM23SYC-F

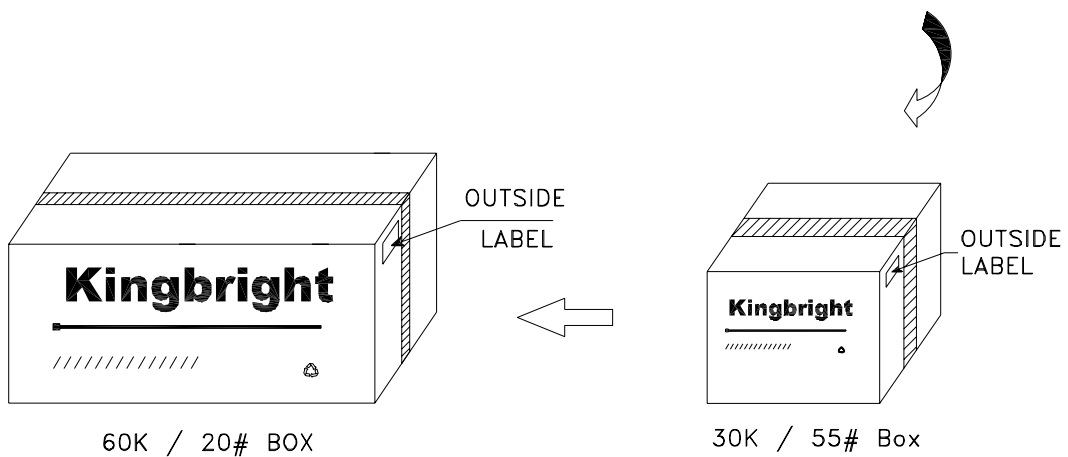
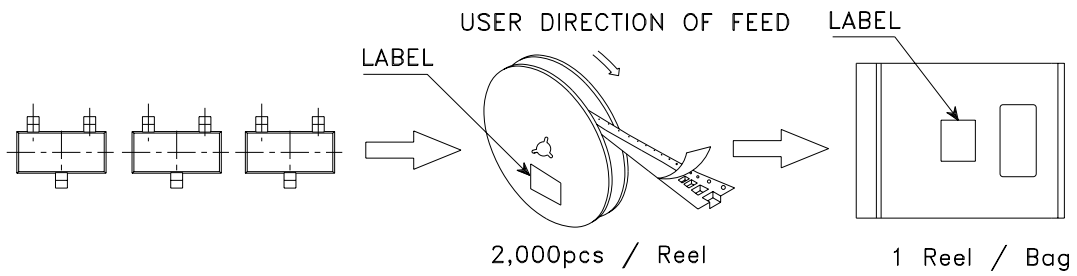

<h1>Kingbright</h1>	
P/NO: AM23xxx	
QTY: 2,000 pcs	Q.C. <span style="border: 1px solid black; border-radius: 50%; padding: 2px;">Q C xx xx xxxx PASSED</span>
S/N: XXXX	
CODE: XXX	
LOT NO:	
 <small>XXXXXXXXXXXXXXXXXXXXXXXXXXXX</small>	
RoHS Compliant	