

VDSL 4 Band Solution CPE (NT)

APC77144

bel

FEATURES

- Compact four band packet over VDSL (4bPoVDSL)
- Minimum footprint design for maximized port density
- Optimized for use with Infineon 22810, 22815 and 22834 chipsets
- Plan 998 specification



BLOCK DIAGRAM

APC77144

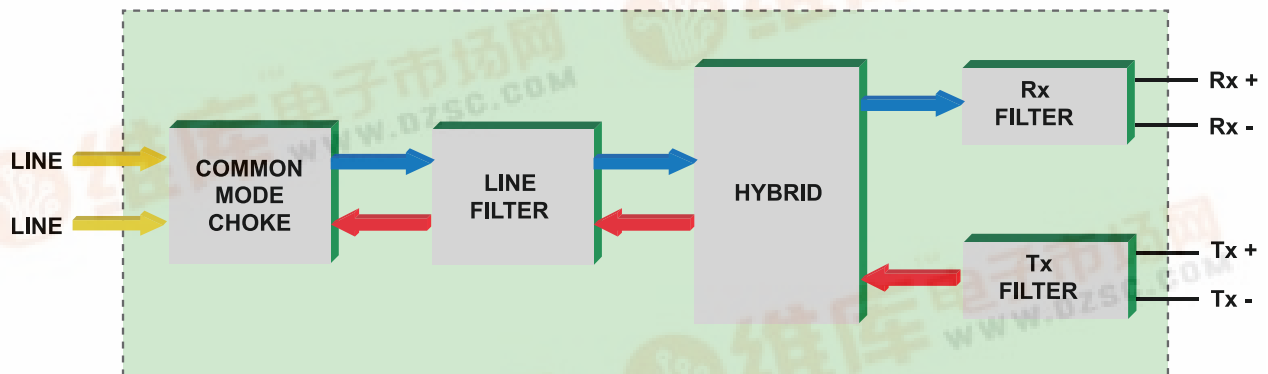



VDSL 4 Band Solution CPE (NT)

APC77144

BAND ALLOCATION

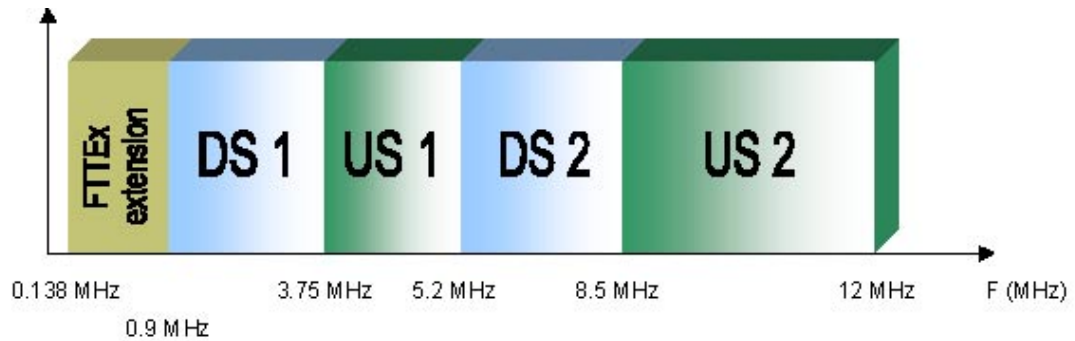

FREQUENCY RESPONSE

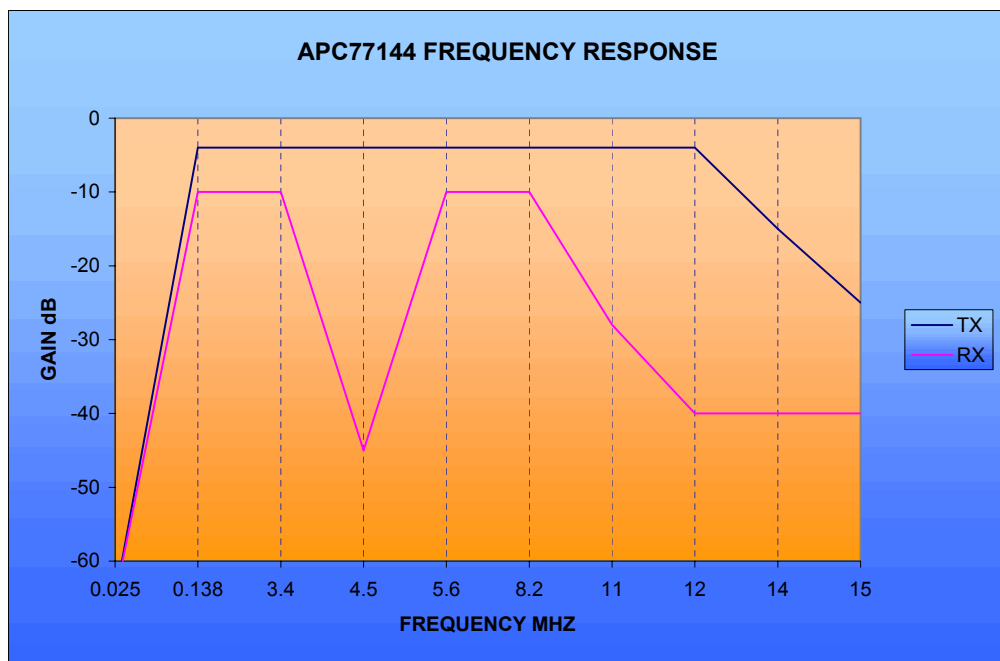



VDSL 4 Band Solution CPE (NT)
APC77144

MECHANICAL

APC77144

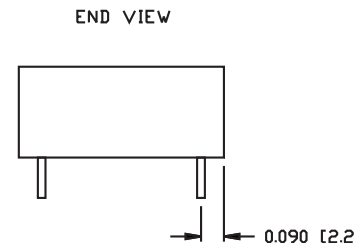
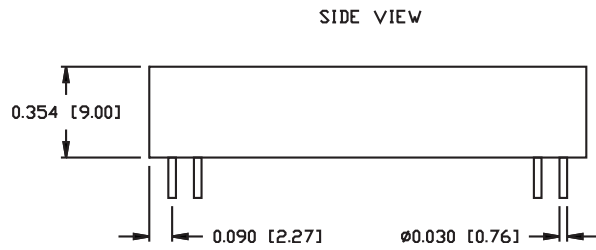
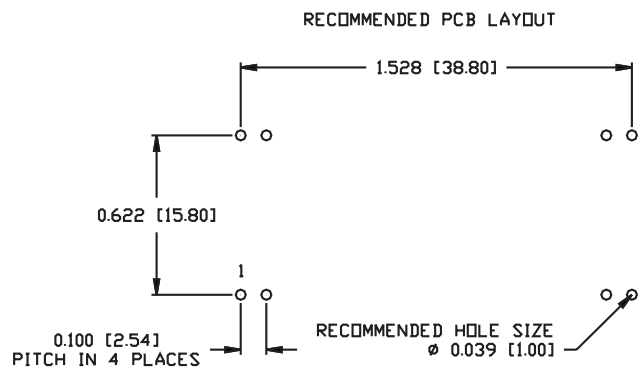
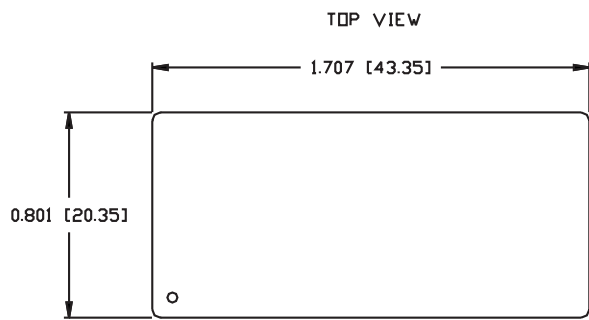

Pin Number	Signal Name
1	Line+
2	Line-
3	TX+
4	TX-
5	RX+
6	RX-
7 & 8	N/C

©2004 Bel Fuse Inc. Specifications subject to change without notice. 11.03.04

CORPORATE

Bel Fuse Inc.
 206 Van Vorst Street
 Jersey City, NJ 07302
 Tel 201-432-0463
 Fax 201-432-9542
 www.belfuse.com

FAR EAST

Bel Fuse Ltd.
 8F / 8 Luk Hop Street
 San Po Kong
 Kowloon, Hong Kong
 Tel 852-2328-5515
 Fax 852-2352-3706

EUROPE

Bel Stewart Connector
 45/46 Riverside
 Medway City Estate
 Rochester, Kent ME2 4DP U.K.
 Tel 44-1634-722890
 Fax 44-1634-716677