

Dual Common Anode diodes Power Module

$V_{RRM} = 600V$
 $I_C = 400A @ T_c = 80^\circ C$

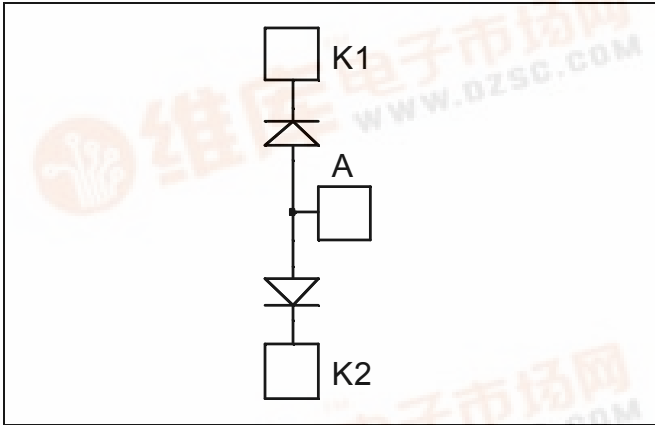

Application

- Uninterruptible Power Supply (UPS)
- Induction heating
- Welding equipment
- High speed rectifiers

Features

- Ultra fast recovery times
- Soft recovery characteristics
- Very low stray inductance
- High blocking voltage
- High current
- Low leakage current
- Very low stray inductance
 - Symmetrical design
 - M5 power connectors
- High level of integration

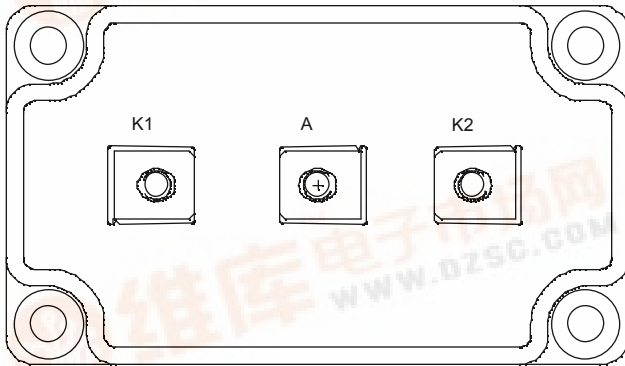

Benefits

- Outstanding performance at high frequency operation
- Low losses
- Low noise switching
- Direct mounting to heatsink (isolated package)
- Low junction to case thermal resistance

Absolute maximum ratings

Symbol	Parameter	Max ratings	Unit
V_R	Maximum DC reverse Voltage	600	V
V_{RRM}	Maximum Peak Repetitive Reverse Voltage		
$I_{F(AV)}$	Maximum Average Forward Current	Duty cycle = 50% $T_C = 25^\circ C$	500
		$T_C = 80^\circ C$	400
$I_{F(RMS)}$	RMS Forward Current	Duty cycle = 50% $T_C = 45^\circ C$	500
I_{FSM}	Non-Repetitive Forward Surge Current	8.3ms $T_C = 45^\circ C$	3000

All ratings @ $T_j = 25^\circ\text{C}$ unless otherwise specified

Electrical Characteristics

Symbol	Characteristic	Test Conditions	Min	Typ	Max	Unit
V_F	Diode Forward Voltage	$I_F = 400\text{A}$		1.6	2.0	V
		$I_F = 800\text{A}$		2.0		
		$I_F = 400\text{A}$	$T_j = 125^\circ\text{C}$		1.3	
I_{RM}	Maximum Reverse Leakage Current	$V_R = 600\text{V}$	$T_j = 25^\circ\text{C}$		750	μA
			$T_j = 125^\circ\text{C}$		1000	
C_T	Junction Capacitance	$V_R = 600\text{V}$		760		pF

Dynamic Characteristics

Symbol	Characteristic	Test Conditions	Min	Typ	Max	Unit
t_{rr}	Reverse Recovery Time	$I_F = 1\text{A}, V_R = 30\text{V}$ $di/dt = 400\text{A}/\mu\text{s}$	$T_j = 25^\circ\text{C}$		34	ns
t_{rr}	Reverse Recovery Time		$T_j = 25^\circ\text{C}$		160	ns
			$T_j = 125^\circ\text{C}$		220	
Q_{rr}	Reverse Recovery Charge	$I_F = 400\text{A}$ $V_R = 400\text{V}$ $di/dt = 800\text{A}/\mu\text{s}$	$T_j = 25^\circ\text{C}$		1.16	μC
			$T_j = 125^\circ\text{C}$		6.12	
I_{RRM}	Reverse Recovery Current		$T_j = 25^\circ\text{C}$		20	A
			$T_j = 125^\circ\text{C}$		52	
t_{rr}	Reverse Recovery Time	$I_F = 400\text{A}$ $V_R = 400\text{V}$ $di/dt = 4000\text{A}/\mu\text{s}$	$T_j = 125^\circ\text{C}$		100	ns
Q_{rr}	Reverse Recovery Charge				11.6	μC
I_{RRM}	Reverse Recovery Current				176	A

Thermal and package characteristics

Symbol	Characteristic	Min	Typ	Max	Unit	
R_{thJC}	Junction to Case			0.14	$^\circ\text{C}/\text{W}$	
V_{ISOL}	RMS Isolation Voltage, any terminal to case $t = 1\text{ min}$, $I_{isol} < 1\text{mA}$, 50/60Hz	2500			V	
T_j	Operating junction temperature range	-40		175	$^\circ\text{C}$	
T_{STG}	Storage Temperature Range	-40		125		
T_C	Operating Case Temperature	-40		100		
Torque	Mounting torque	To heatsink	M6	3	5	N.m
		For terminals	M5	2	3.5	
Wt	Package Weight			280	g	

Typical Performance Curve

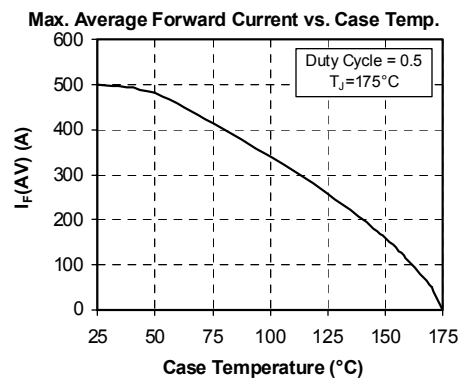
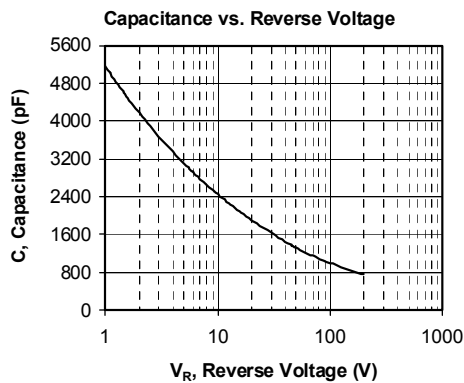
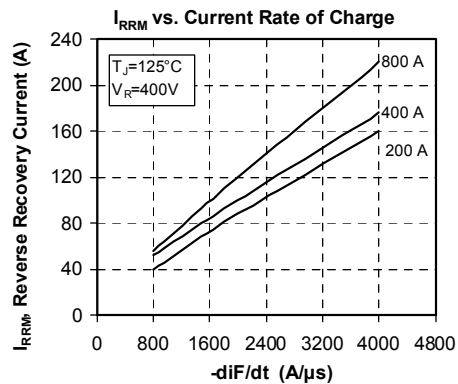
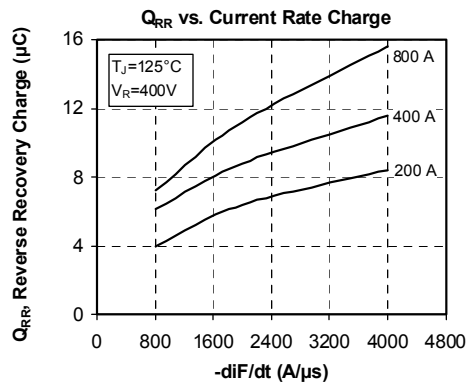
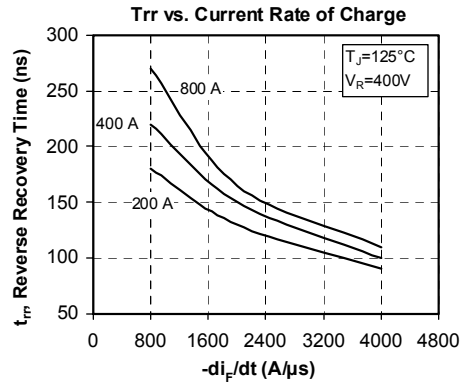
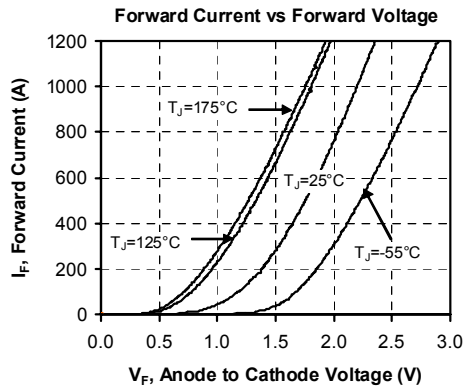
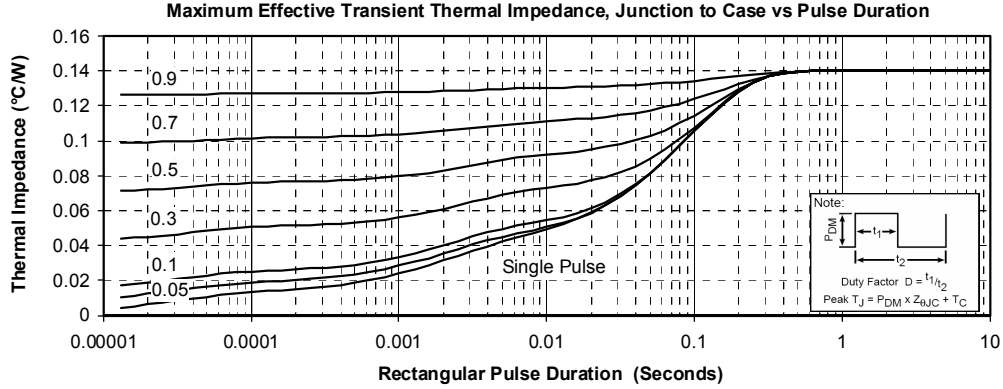

Package outline (dimensions in mm)

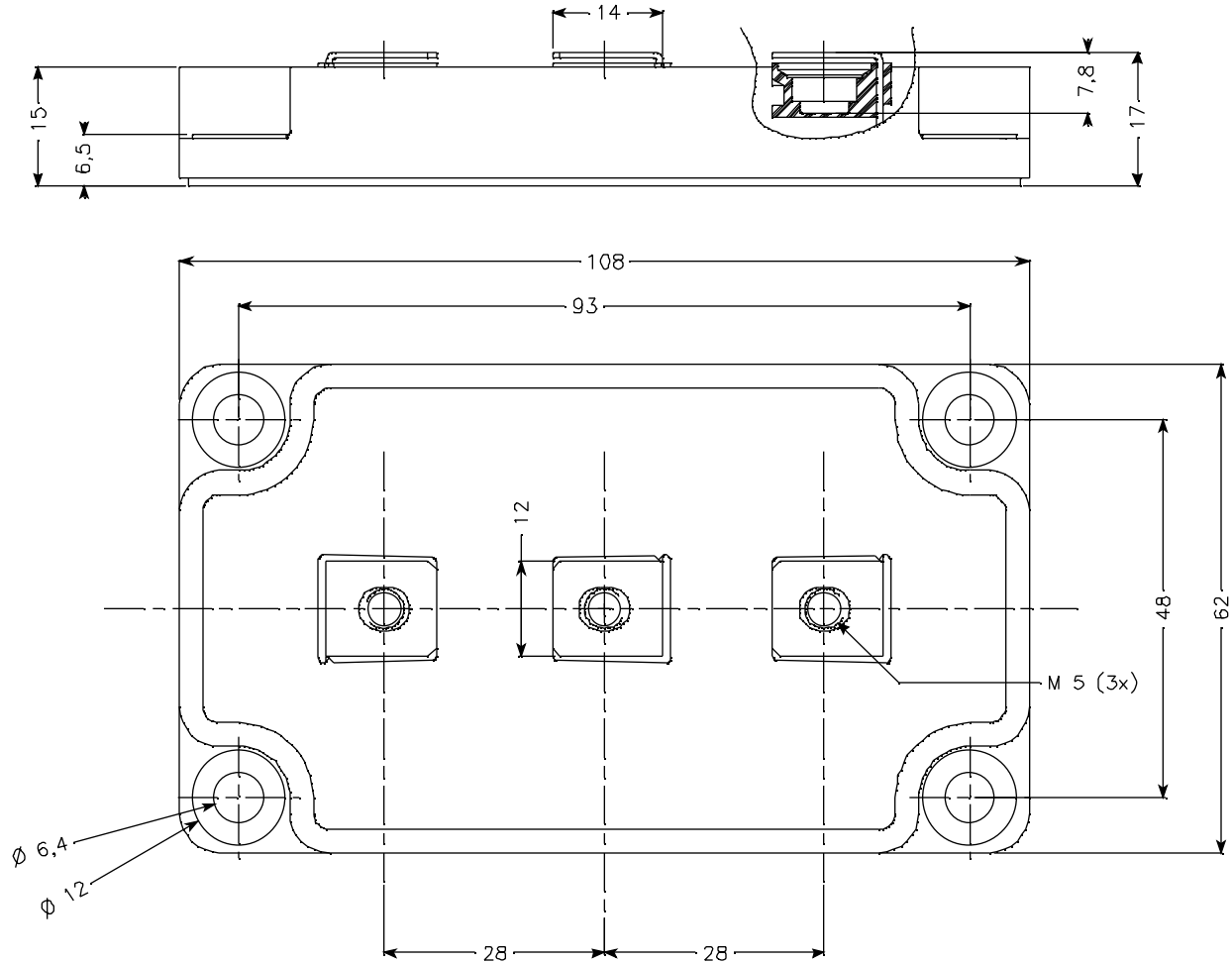

APT reserves the right to change, without notice, the specifications and information contained herein

APT's products are covered by one or more of U.S. patents 4,895,810 5,045,903 5,089,434 5,182,234 5,019,522 5,262,336 6,503,786 5,256,583 4,748,103 5,283,202 5,231,474 5,434,095 5,528,058 and foreign patents. U.S. and Foreign patents pending. All Rights Reserved.