



**APT24F50B**  
**APT24F50S**

500V, 24A, 0.24Ω Max,  $t_{rr} \leq 210ns$

## N-Channel FREDFET

Power MOS 8™ is a high speed, high voltage N-channel switch-mode power MOSFET. This 'FREDFET' version has a drain-source (body) diode that has been optimized for high reliability in ZVS phase shifted bridge and other circuits through reduced  $t_{rr}$ , soft recovery, and high recovery  $dv/dt$  capability. Low gate charge, high gain, and a greatly reduced ratio of  $C_{rSS}/C_{iSS}$  result in excellent noise immunity and low switching loss. The intrinsic gate resistance and capacitance of the poly-silicon gate structure help control  $di/dt$  during switching, resulting in low EMI and reliable paralleling, even when switching at very high frequency.

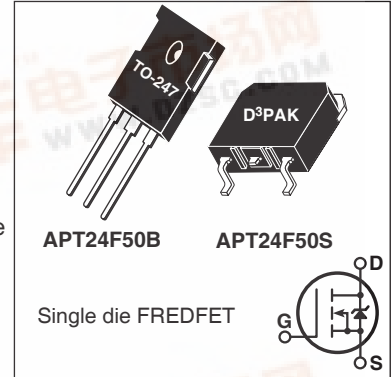

### FEATURES

- Fast switching with low EMI
- Low  $t_{rr}$  for high reliability
- Ultra low  $C_{rSS}$  for improved noise immunity
- Low gate charge
- Avalanche energy rated
- RoHS compliant

### TYPICAL APPLICATIONS

- ZVS phase shifted and other full bridge
- Half bridge
- PFC and other boost converter
- Buck converter
- Single and two switch forward
- Flyback

### Absolute Maximum Ratings

Symbol	Parameter	Ratings	Unit
$I_D$	Continuous Drain Current @ $T_C = 25^\circ C$	24	A
	Continuous Drain Current @ $T_C = 100^\circ C$	15	
$I_{DM}$	Pulsed Drain Current <sup>①</sup>	70	
$V_{GS}$	Gate-Source Voltage	±30	V
$E_{AS}$	Single Pulse Avalanche Energy <sup>②</sup>	495	mJ
$I_{AR}$	Avalanche Current, Repetitive or Non-Repetitive	11	A

### Thermal and Mechanical Characteristics

Symbol	Characteristic	Min	Typ	Max	Unit
$P_D$	Total Power Dissipation @ $T_C = 25^\circ C$			335	W
$R_{\theta JC}$	Junction to Case Thermal Resistance			0.37	°C/W
$R_{\theta CS}$	Case to Sink Thermal Resistance, Flat, Greased Surface		0.15		
$T_J, T_{STG}$	Operating and Storage Junction Temperature Range	-55		150	°C
$T_L$	Soldering Temperature for 10 Seconds (1.6mm from case)			300	
$W_T$	Package Weight		0.22		oz
			6.2		g
Torque	Mounting Torque ( TO-247 Package), 6-32 or M3 screw			10	in-lbf
				1.1	N·m

### Static Characteristics

T<sub>J</sub> = 25°C unless otherwise specified

AP24F50B\_S

Symbol	Parameter	Test Conditions	Min	Typ	Max	Unit
V <sub>BR(DSS)</sub>	Drain-Source Breakdown Voltage	V <sub>GS</sub> = 0V, I <sub>D</sub> = 250μA	500			V
ΔV <sub>BR(DSS)/ΔT<sub>J</sub></sub>	Breakdown Voltage Temperature Coefficient	Reference to 25°C, I <sub>D</sub> = 250μA		0.60		V/°C
R <sub>DS(on)</sub>	Drain-Source On Resistance <sup>③</sup>	V <sub>GS</sub> = 10V, I <sub>D</sub> = 11A		0.11	0.14	Ω
V <sub>GS(th)</sub>	Gate-Source Threshold Voltage	V <sub>GS</sub> = V <sub>DS</sub> , I <sub>D</sub> = 1mA	3	4	5	V
ΔV <sub>GS(th)/ΔT<sub>J</sub></sub>	Threshold Voltage Temperature Coefficient			-10		mV/°C
I <sub>DSS</sub>	Zero Gate Voltage Drain Current	V <sub>DS</sub> = 500V V <sub>GS</sub> = 0V	T <sub>J</sub> = 25°C		250	μA
			T <sub>J</sub> = 125°C		1000	
I <sub>GSS</sub>	Gate-Source Leakage Current	V <sub>GS</sub> = ±30V			±100	nA

### Dynamic Characteristics

T<sub>J</sub> = 25°C unless otherwise specified

Symbol	Parameter	Test Conditions	Min	Typ	Max	Unit
g <sub>fs</sub>	Forward Transconductance	V <sub>DS</sub> = 50V, I <sub>D</sub> = 11A		17		S
C <sub>iss</sub>	Input Capacitance	V <sub>GS</sub> = 0V, V <sub>DS</sub> = 25V f = 1MHz		3630		pF
C <sub>rss</sub>	Reverse Transfer Capacitance			50		
C <sub>oss</sub>	Output Capacitance			390		
C <sub>o(cr)</sub> <sup>④</sup>	Effective Output Capacitance, Charge Related	V <sub>GS</sub> = 0V, V <sub>DS</sub> = 0V to 333V		225		pF
C <sub>o(er)</sub> <sup>⑤</sup>	Effective Output Capacitance, Energy Related			115		
Q <sub>g</sub>	Total Gate Charge	V <sub>GS</sub> = 0 to 10V, I <sub>D</sub> = 11A, V <sub>DS</sub> = 250V		90		nC
Q <sub>gs</sub>	Gate-Source Charge			21		
Q <sub>gd</sub>	Gate-Drain Charge			41		
t <sub>d(on)</sub>	Turn-On Delay Time	<b>Resistive Switching</b> V <sub>DD</sub> = 333V, I <sub>D</sub> = 11A R <sub>G</sub> = 4.7Ω <sup>⑥</sup> , V <sub>GG</sub> = 15V		16		ns
t <sub>r</sub>	Current Rise Time			19		
t <sub>d(off)</sub>	Turn-Off Delay Time			41		
t <sub>f</sub>	Current Fall Time			14		

### Source-Drain Diode Characteristics

Symbol	Parameter	Test Conditions	Min	Typ	Max	Unit
I <sub>S</sub>	Continuous Source Current (Body Diode)	MOSFET symbol showing the integral reverse p-n junction diode (body diode)			24	A
I <sub>SM</sub>	Pulsed Source Current (Body Diode) <sup>①</sup>				70	
V <sub>SD</sub>	Diode Forward Voltage	I <sub>SD</sub> = 11A, T <sub>J</sub> = 25°C, V <sub>GS</sub> = 0V			1.0	V
t <sub>rr</sub>	Reverse Recovery Time	I <sub>SD</sub> = 11A <sup>③</sup> di <sub>SD</sub> /dt = 100A/μs V <sub>DD</sub> = 100V	T <sub>J</sub> = 25°C		210	ns
			T <sub>J</sub> = 125°C		400	
Q <sub>rr</sub>	Reverse Recovery Charge		T <sub>J</sub> = 25°C		0.68	μC
			T <sub>J</sub> = 125°C		1.64	
I <sub>rrm</sub>	Reverse Recovery Current	T <sub>J</sub> = 25°C		7.1	A	
		T <sub>J</sub> = 125°C		9.7		
dv/dt	Peak Recovery dv/dt	I <sub>SD</sub> ≤ 11A, di/dt ≤ 1000A/μs, V <sub>DD</sub> = 333V, T <sub>J</sub> = 125°C			20	V/ns

① Repetitive Rating: Pulse width and case temperature limited by maximum junction temperature.

② Starting at T<sub>J</sub> = 25°C, L = 8.18mH, R<sub>G</sub> = 4.7Ω, I<sub>AS</sub> = 11A.

③ Pulse test: Pulse Width < 380μs, duty cycle < 2%.

④ C<sub>o(cr)</sub> is defined as a fixed capacitance with the same stored charge as C<sub>OSS</sub> with V<sub>DS</sub> = 67% of V<sub>(BR)DSS</sub>.

⑤ C<sub>o(er)</sub> is defined as a fixed capacitance with the same stored energy as C<sub>OSS</sub> with V<sub>DS</sub> = 67% of V<sub>(BR)DSS</sub>. To calculate C<sub>o(er)</sub> for any value of V<sub>DS</sub> less than V<sub>(BR)DSS</sub>, use this equation: C<sub>o(er)</sub> = -8.43E-8/V<sub>DS</sub><sup>2</sup> + 1.96E-8/V<sub>DS</sub> + 5.61E-11.

⑥ R<sub>G</sub> is external gate resistance, not including internal gate resistance or gate driver impedance. (MIC4452)

Microsemi reserves the right to change, without notice, the specifications and information contained herein.

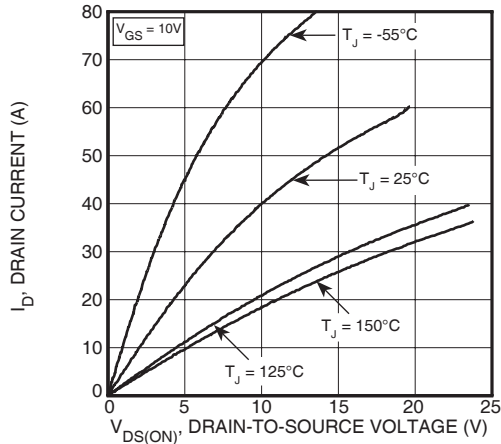

Figure 1, Output Characteristics

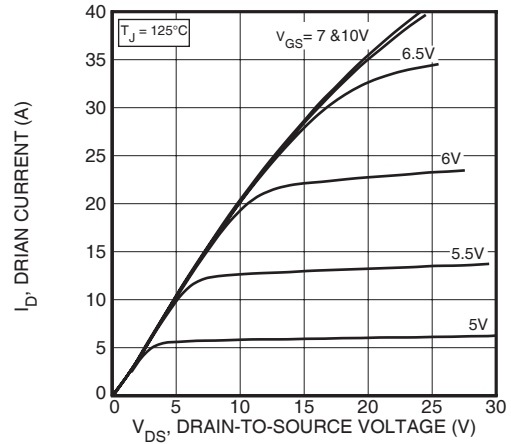

Figure 2, Output Characteristics

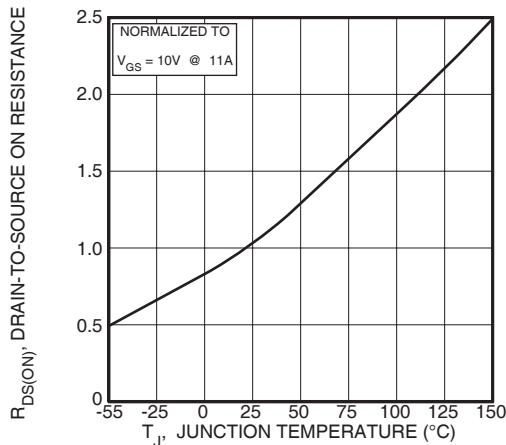

Figure 3,  $R_{DS(ON)}$  vs Junction Temperature

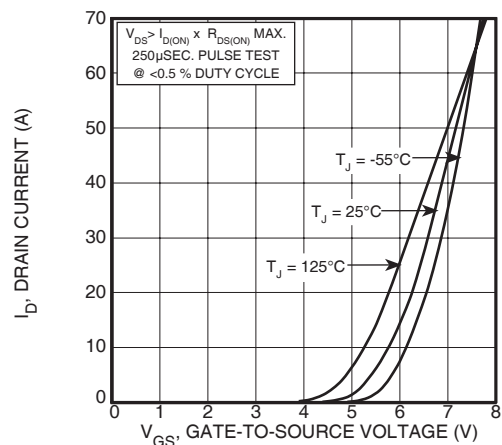

Figure 4, Transfer Characteristics

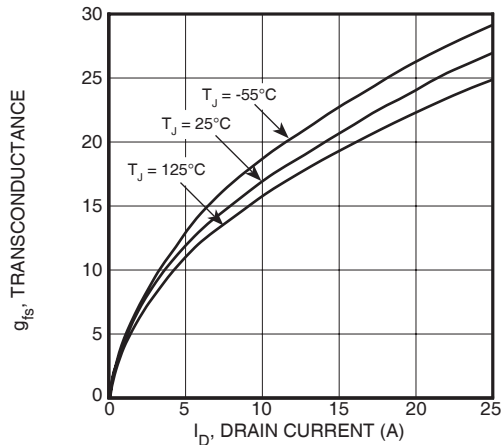

Figure 5, Gain vs Drain Current

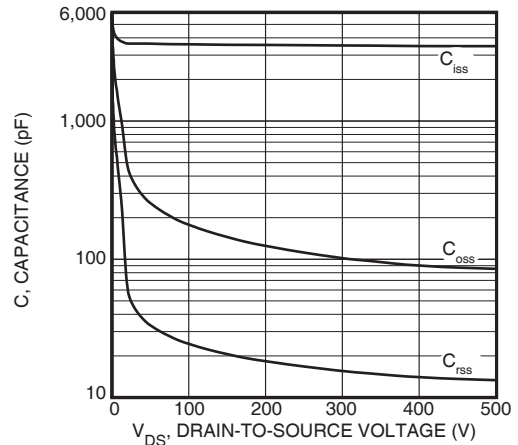

Figure 6, Capacitance vs Drain-to-Source Voltage

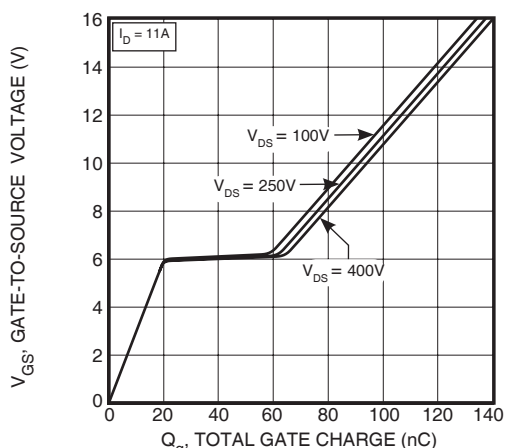

Figure 7, Gate Charge vs Gate-to-Source Voltage

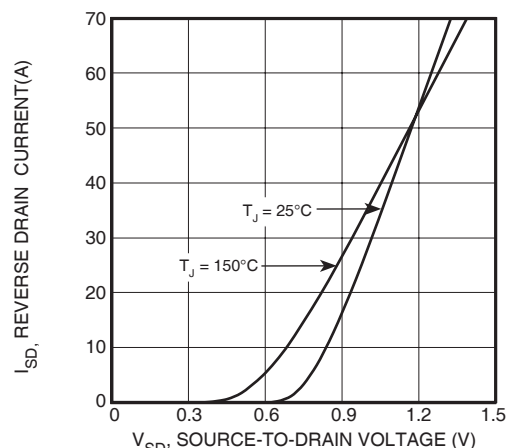

Figure 8, Drain Current vs Source-to-Drain Voltage

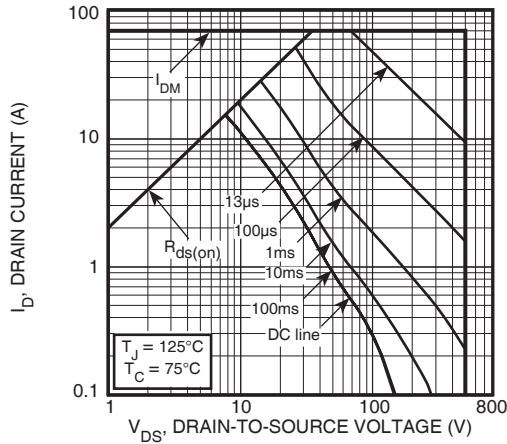

Figure 9, Forward Safe Operating Area

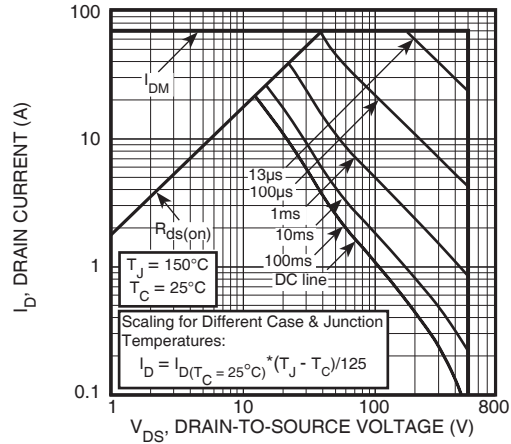

Figure 10, Maximum Forward Safe Operating Area

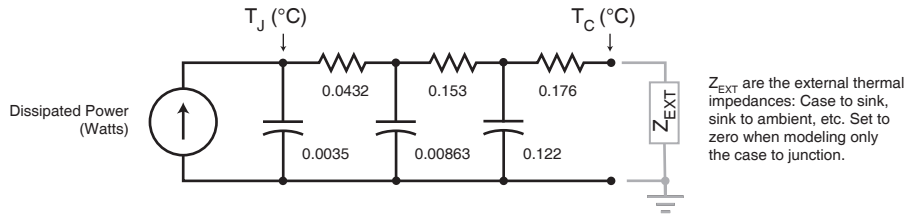

Figure 11, Transient Thermal Impedance Model

$Z_{EXT}$  are the external thermal impedances: Case to sink, sink to ambient, etc. Set to zero when modeling only the case to junction.

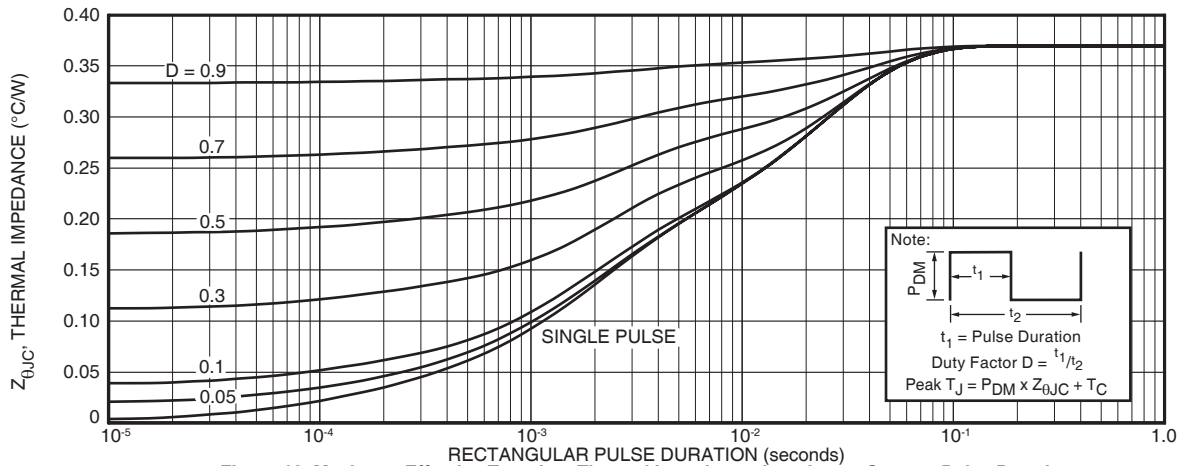
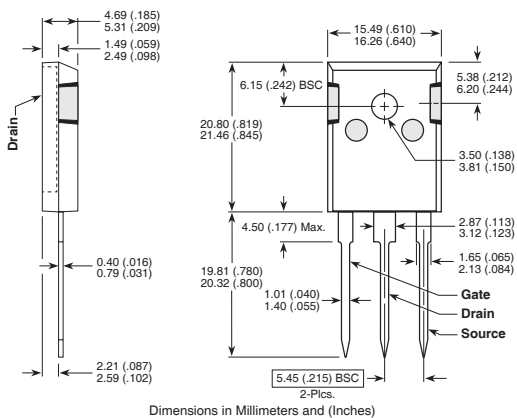

Figure 12. Maximum Effective Transient Thermal Impedance Junction-to-Case vs Pulse Duration

TO-247 (B) Package Outline



D<sup>3</sup>PAK Package Outline

