



# APT4020BVR

400V 23A 0.200Ω

## POWER MOS V<sup>®</sup>

Power MOS V<sup>®</sup> is a new generation of high voltage N-Channel enhancement mode power MOSFETs. This new technology minimizes the JFET effect, increases packing density and reduces the on-resistance. Power MOS V<sup>®</sup> also achieves faster switching speeds through optimized gate layout.

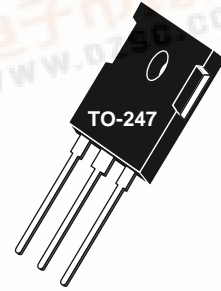

- Faster Switching
- Lower Leakage
- 100% Avalanche Tested
- Popular TO-247 Package

### MAXIMUM RATINGS

All Ratings: T<sub>C</sub> = 25°C unless otherwise specified.

Symbol	Parameter	APT4020BVR	UNIT
V <sub>DSS</sub>	Drain-Source Voltage	400	Volts
I <sub>D</sub>	Continuous Drain Current @ T <sub>C</sub> = 25°C	23	Amps
I <sub>DM</sub>	Pulsed Drain Current <sup>①</sup>	92	
V <sub>GS</sub>	Gate-Source Voltage Continuous	±30	Volts
V <sub>GSM</sub>	Gate-Source Voltage Transient	±40	
P <sub>D</sub>	Total Power Dissipation @ T <sub>C</sub> = 25°C	250	Watts
	Linear Derating Factor	2	W/°C
T <sub>J</sub> , T <sub>STG</sub>	Operating and Storage Junction Temperature Range	-55 to 150	°C
T <sub>L</sub>	Lead Temperature: 0.063" from Case for 10 Sec.	300	
I <sub>AR</sub>	Avalanche Current <sup>①</sup> (Repetitive and Non-Repetitive)	23	Amps
E <sub>AR</sub>	Repetitive Avalanche Energy <sup>①</sup>	30	mJ
E <sub>AS</sub>	Single Pulse Avalanche Energy <sup>④</sup>	960	

### STATIC ELECTRICAL CHARACTERISTICS

Symbol	Characteristic / Test Conditions	MIN	TYP	MAX	UNIT
BV <sub>DSS</sub>	Drain-Source Breakdown Voltage (V <sub>GS</sub> = 0V, I <sub>D</sub> = 250μA)	400			Volts
I <sub>D(on)</sub>	On State Drain Current <sup>②</sup> (V <sub>DS</sub> > I <sub>D(on)</sub> × R <sub>DS(on)</sub> Max, V <sub>GS</sub> = 10V)	23			Amps
R <sub>DS(on)</sub>	Drain-Source On-State Resistance <sup>②</sup> (V <sub>GS</sub> = 10V, 0.5 I <sub>D[Cont.]</sub> )			0.20	Ohms
I <sub>DSS</sub>	Zero Gate Voltage Drain Current (V <sub>DS</sub> = V <sub>DSS</sub> , V <sub>GS</sub> = 0V)			25	μA
	Zero Gate Voltage Drain Current (V <sub>DS</sub> = 0.8 V <sub>DSS</sub> , V <sub>GS</sub> = 0V, T <sub>C</sub> = 125°C)			250	
I <sub>GSS</sub>	Gate-Source Leakage Current (V <sub>GS</sub> = ±30V, V <sub>DS</sub> = 0V)			±100	nA
V <sub>GS(th)</sub>	Gate Threshold Voltage (V <sub>DS</sub> = V <sub>GS</sub> , I <sub>D</sub> = 1.0mA)	2		4	Volts

**CAUTION:** These Devices are Sensitive to Electrostatic Discharge. Proper Handling Procedures Should Be Followed.

APT Website - <http://www.advancedpower.com>

Bend, Oregon 97702-1035 Phone: (541) 382-8028 FAX: (541) 388-0364

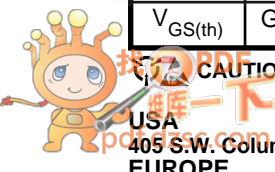

## DYNAMIC CHARACTERISTICS

APT4020BVR

Symbol	Characteristic	Test Conditions	MIN	TYP	MAX	UNIT
$C_{iss}$	Input Capacitance	$V_{GS} = 0V$ $V_{DS} = 25V$ $f = 1 \text{ MHz}$		2650	3180	pF
$C_{oss}$	Output Capacitance			400	560	
$C_{rss}$	Reverse Transfer Capacitance			180	270	
$Q_g$	Total Gate Charge <sup>③</sup>	$V_{GS} = 10V$ $V_{DD} = 0.5 V_{DSS}$ $I_D = I_{D[Cont.]} @ 25^\circ C$		120	180	nC
$Q_{gs}$	Gate-Source Charge			16	24	
$Q_{gd}$	Gate-Drain ("Miller") Charge			60	90	
$t_{d(on)}$	Turn-on Delay Time	$V_{GS} = 15V$ $V_{DD} = 0.5 V_{DSS}$ $I_D = I_{D[Cont.]} @ 25^\circ C$ $R_G = 1.6\Omega$		10	20	ns
$t_r$	Rise Time			11	22	
$t_{d(off)}$	Turn-off Delay Time			38	60	
$t_f$	Fall Time			7	14	

## SOURCE-DRAIN DIODE RATINGS AND CHARACTERISTICS

Symbol	Characteristic / Test Conditions	MIN	TYP	MAX	UNIT
$I_S$	Continuous Source Current (Body Diode)			23	Amps
$I_{SM}$	Pulsed Source Current <sup>①</sup> (Body Diode)			92	
$V_{SD}$	Diode Forward Voltage <sup>②</sup> ( $V_{GS} = 0V, I_S = -I_{D[Cont.]}$ )			1.3	Volts
$t_{rr}$	Reverse Recovery Time ( $I_S = -I_{D[Cont.]}, di_S/dt = 100A/\mu s$ )		360		ns
$Q_{rr}$	Reverse Recovery Charge ( $I_S = -I_{D[Cont.]}, di_S/dt = 100A/\mu s$ )		6		$\mu C$

## THERMAL CHARACTERISTICS

Symbol	Characteristic	MIN	TYP	MAX	UNIT
$R_{\theta JC}$	Junction to Case			0.50	$^\circ C/W$
$R_{\theta JA}$	Junction to Ambient			40	

① Repetitive Rating: Pulse width limited by maximum junction temperature.

③ See MIL-STD-750 Method 3471

② Pulse Test: Pulse width < 380  $\mu s$ , Duty Cycle < 2%

④ Starting  $T_j = +25^\circ C$ ,  $L = 3.63mH$ ,  $R_G = 25\Omega$ , Peak  $I_L = 23A$

APT Reserves the right to change, without notice, the specifications and information contained herein.

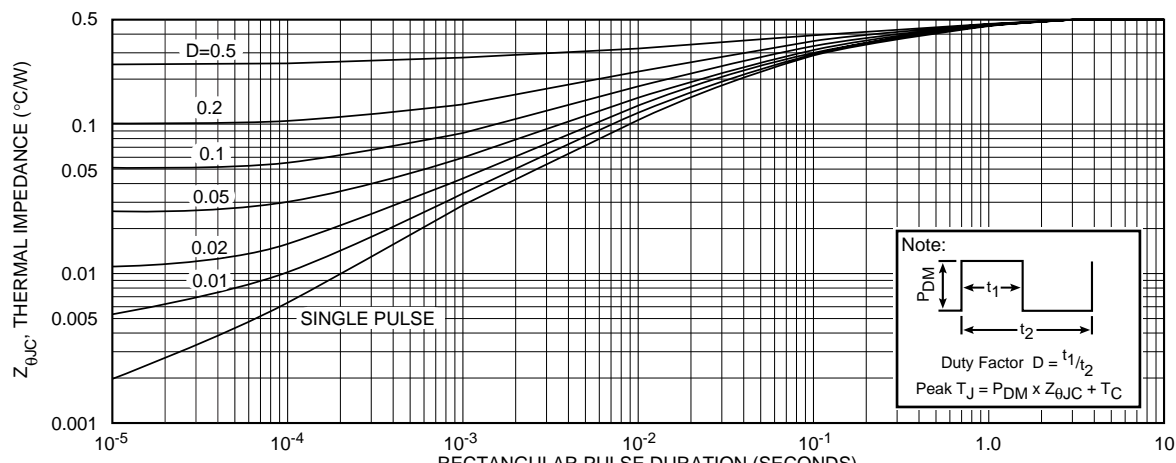

**APT4020BVR**

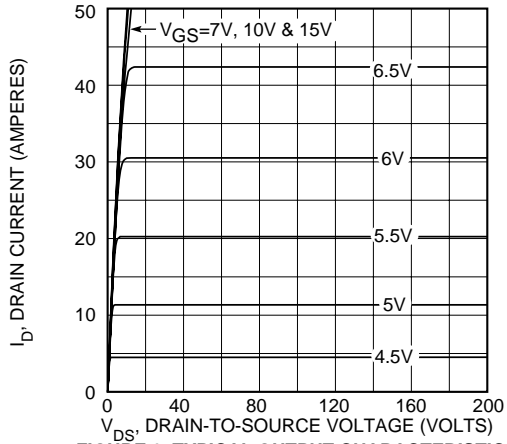

**FIGURE 2, TYPICAL OUTPUT CHARACTERISTICS**

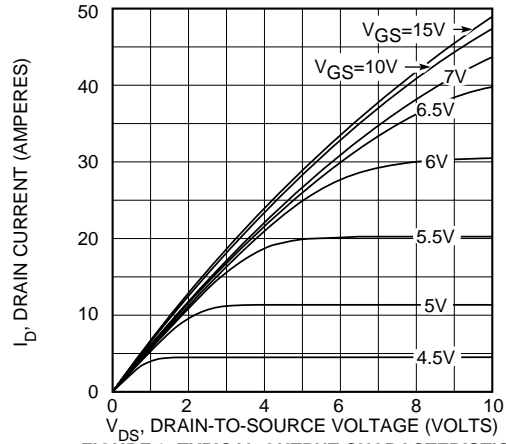

**FIGURE 3, TYPICAL OUTPUT CHARACTERISTICS**

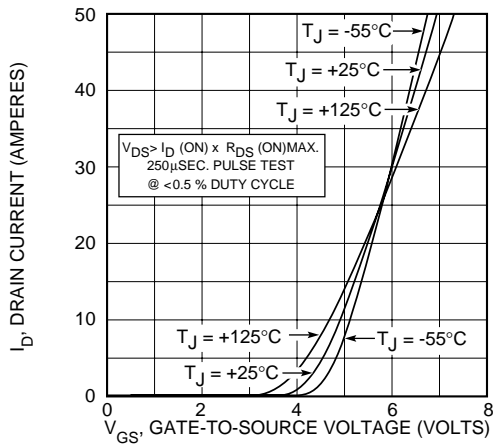

**FIGURE 4, TYPICAL TRANSFER CHARACTERISTICS**

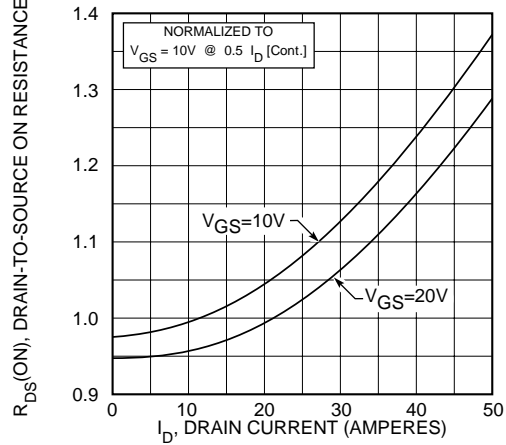

**FIGURE 5,  $R_{DS(ON)}$  vs DRAIN CURRENT**

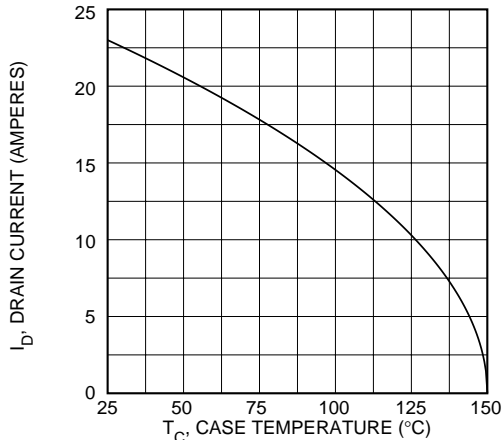

**FIGURE 6, MAXIMUM DRAIN CURRENT vs CASE TEMPERATURE**

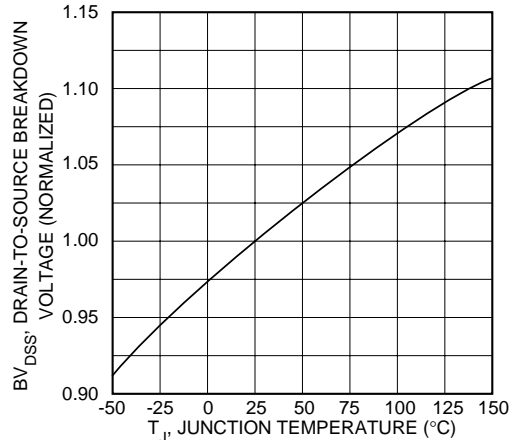

**FIGURE 7, BREAKDOWN VOLTAGE vs TEMPERATURE**

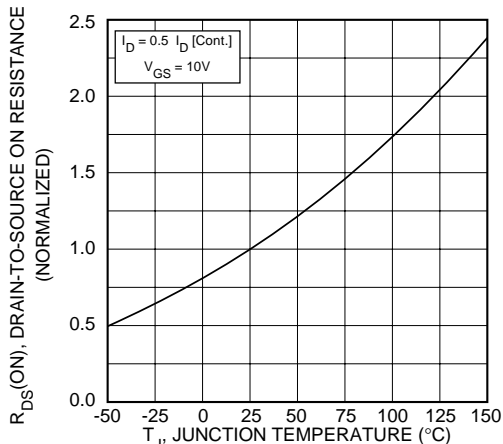

**FIGURE 8, ON-RESISTANCE vs. TEMPERATURE**

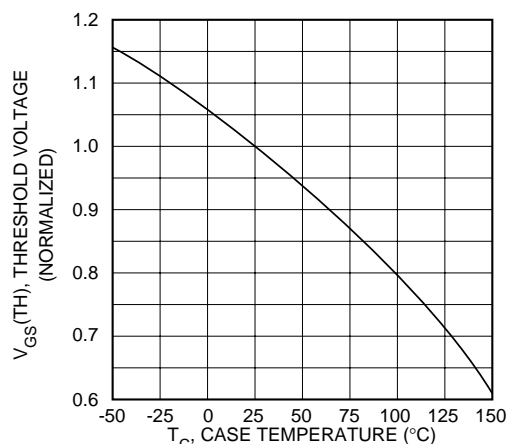

**FIGURE 9, THRESHOLD VOLTAGE vs TEMPERATURE**

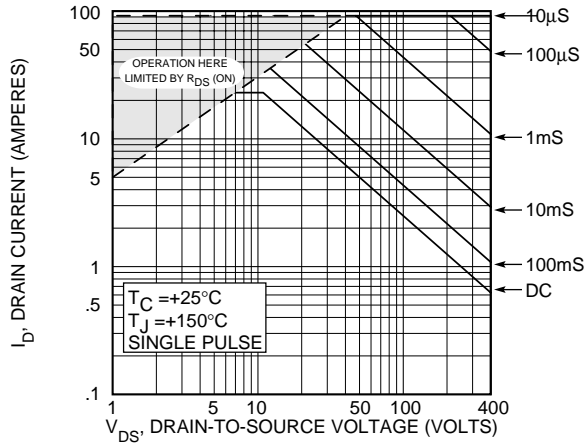

FIGURE 10, MAXIMUM SAFE OPERATING AREA

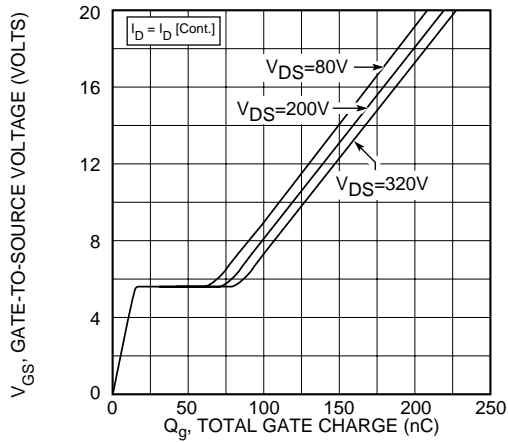

FIGURE 12, GATE CHARGES vs GATE-TO-SOURCE VOLTAGE

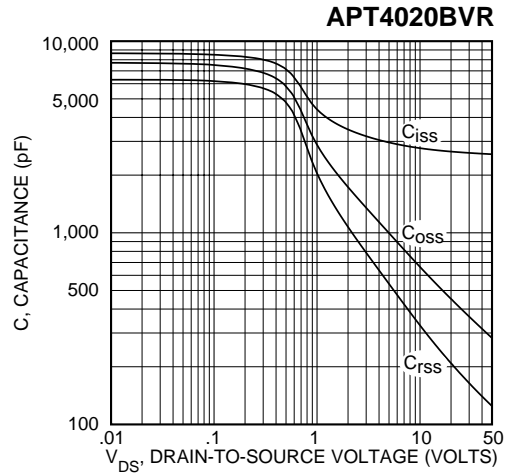

FIGURE 11, TYPICAL CAPACITANCE vs DRAIN-TO-SOURCE VOLTAGE

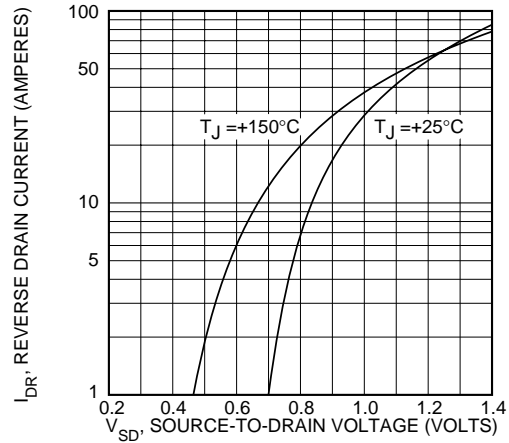
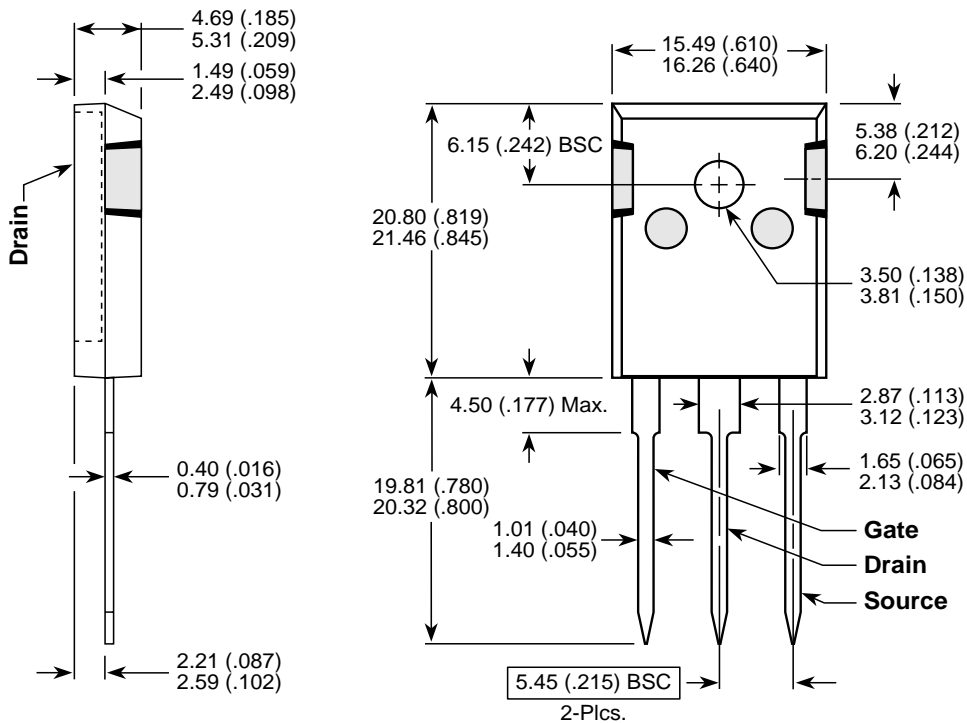

FIGURE 13, TYPICAL SOURCE-DRAIN DIODE FORWARD VOLTAGE

TO-247 Package Outline



Dimensions in Millimeters and (Inches)