



APT5012WVR

500V 40A 0.120Ω

POWER MOS V[®]

Power MOS V[®] is a new generation of high voltage N-Channel enhancement mode power MOSFETs. This new technology minimizes the JFET effect, increases packing density and reduces the on-resistance. Power MOS V[®] also achieves faster switching speeds through optimized gate layout.

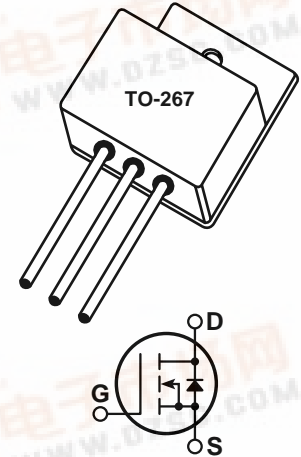

- Faster Switching
- Lower Leakage
- 100% Avalanche Tested
- New TO-267 Package

MAXIMUM RATINGS

All Ratings: T_C = 25°C unless otherwise specified.

Symbol	Parameter	APT5012WVR	UNIT
V _{DSS}	Drain-Source Voltage	500	Volts
I _D	Continuous Drain Current @ T _C = 25°C	40	Amps
I _{DM}	Pulsed Drain Current ^①	160	
V _{GS}	Gate-Source Voltage Continuous	±30	Volts
V _{GSM}	Gate-Source Voltage Transient	±40	
P _D	Total Power Dissipation @ T _C = 25°C	450	Watts
	Linear Derating Factor	3.6	W/°C
T _J , T _{STG}	Operating and Storage Junction Temperature Range	-55 to 150	°C
T _L	Lead Temperature: 0.063" from Case for 10 Sec.	300	
I _{AR}	Avalanche Current ^① (Repetitive and Non-Repetitive)	40	Amps
E _{AR}	Repetitive Avalanche Energy ^①	50	mJ
E _{AS}	Single Pulse Avalanche Energy ^④	2500	

STATIC ELECTRICAL CHARACTERISTICS

Symbol	Characteristic / Test Conditions	MIN	TYP	MAX	UNIT
BV _{DSS}	Drain-Source Breakdown Voltage (V _{GS} = 0V, I _D = 250μA)	500			Volts
I _{D(on)}	On State Drain Current ^② (V _{DS} > I _{D(on)} × R _{DS(on)} Max, V _{GS} = 10V)	40			Amps
R _{DS(on)}	Drain-Source On-State Resistance ^② (V _{GS} = 10V, 0.5 I _{D(Cont.)})			0.120	Ohms
I _{DSS}	Zero Gate Voltage Drain Current (V _{DS} = V _{DSS} , V _{GS} = 0V)			25	μA
	Zero Gate Voltage Drain Current (V _{DS} = 0.8 V _{DSS} , V _{GS} = 0V, T _C = 125°C)			250	
I _{GSS}	Gate-Source Leakage Current (V _{GS} = ±30V, V _{DS} = 0V)			±100	nA
V _{GS(th)}	Gate Threshold Voltage (V _{DS} = V _{GS} , I _D = 2.5mA)	2		4	Volts

CAUTION: These Devices are Sensitive to Electrostatic Discharge. Proper Handling Procedures Should Be Followed.

APT Website - <http://www.advancedpower.com>

DYNAMIC CHARACTERISTICS

APT5012WVR

Symbol	Characteristic	Test Conditions	MIN	TYP	MAX	UNIT
C_{iss}	Input Capacitance	$V_{GS} = 0V$ $V_{DS} = 25V$ $f = 1 \text{ MHz}$		7400	8900	pF
C_{oss}	Output Capacitance			1000	1400	
C_{rss}	Reverse Transfer Capacitance			380	570	
Q_g	Total Gate Charge ^③	$V_{GS} = 10V$ $V_{DD} = 0.5 V_{DSS}$ $I_D = I_{D[Cont.]} @ 25^\circ C$		312	470	nC
Q_{gs}	Gate-Source Charge			50	75	
Q_{gd}	Gate-Drain ("Miller") Charge			127	190	
$t_{d(on)}$	Turn-on Delay Time	$V_{GS} = 15V$ $V_{DD} = 0.5 V_{DSS}$ $I_D = I_{D[Cont.]} @ 25^\circ C$ $R_G = 0.6\Omega$		14	30	ns
t_r	Rise Time			16	32	
$t_{d(off)}$	Turn-off Delay Time			54	80	
t_f	Fall Time			5	10	

SOURCE-DRAIN DIODE RATINGS AND CHARACTERISTICS

Symbol	Characteristic / Test Conditions	MIN	TYP	MAX	UNIT
I_S	Continuous Source Current (Body Diode)			40	Amps
I_{SM}	Pulsed Source Current ^① (Body Diode)			160	
V_{SD}	Diode Forward Voltage ^② ($V_{GS} = 0V, I_S = -I_{D[Cont.]}$)			1.3	Volts
t_{rr}	Reverse Recovery Time ($I_S = -I_{D[Cont.]}, di_S/dt = 100A/\mu s$)		620		ns
Q_{rr}	Reverse Recovery Charge ($I_S = -I_{D[Cont.]}, di_S/dt = 100A/\mu s$)		14.7		μC

THERMAL CHARACTERISTICS

Symbol	Characteristic	MIN	TYP	MAX	UNIT
$R_{\theta JC}$	Junction to Case			0.28	$^\circ C/W$
$R_{\theta JA}$	Junction to Ambient			40	

① Repetitive Rating: Pulse width limited by maximum junction temperature.

③ See MIL-STD-750 Method 3471

② Pulse Test: Pulse width < 380 μs , Duty Cycle < 2%

④ Starting $T_j = +25^\circ C$, $L = 3.13mH$, $R_G = 25\Omega$, Peak $I_L = 40A$

APT Reserves the right to change, without notice, the specifications and information contained herein.

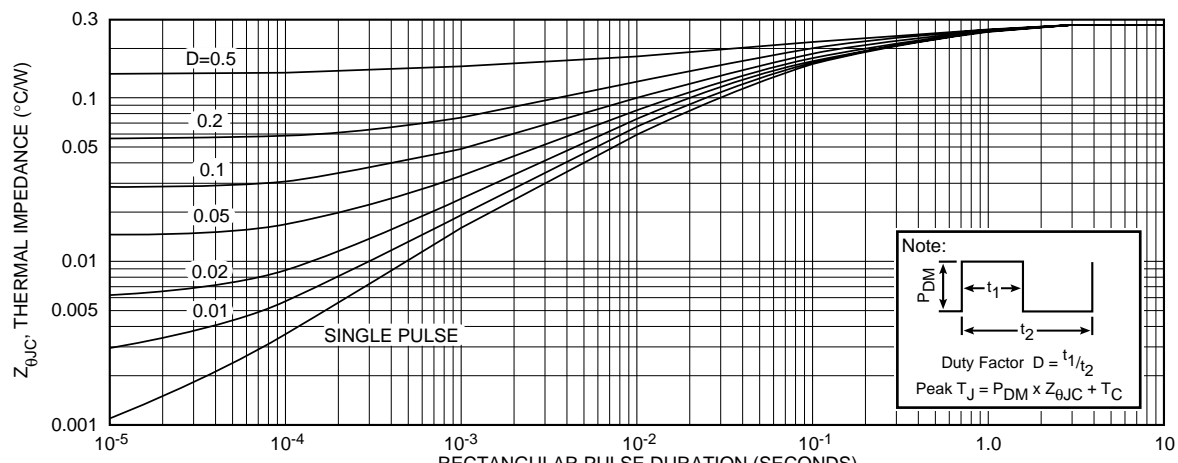

APT5012WVR

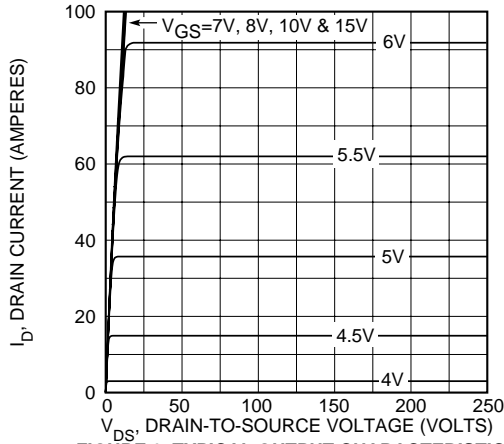

FIGURE 2, TYPICAL OUTPUT CHARACTERISTICS

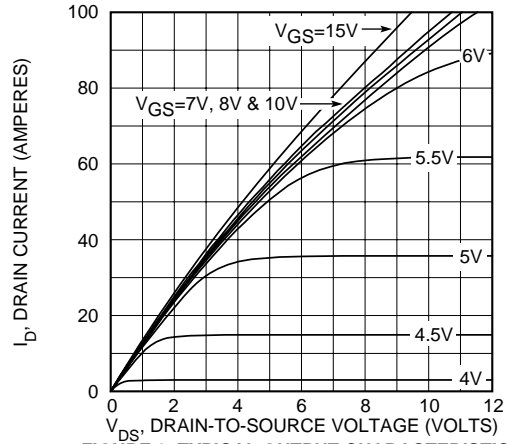

FIGURE 3, TYPICAL OUTPUT CHARACTERISTICS

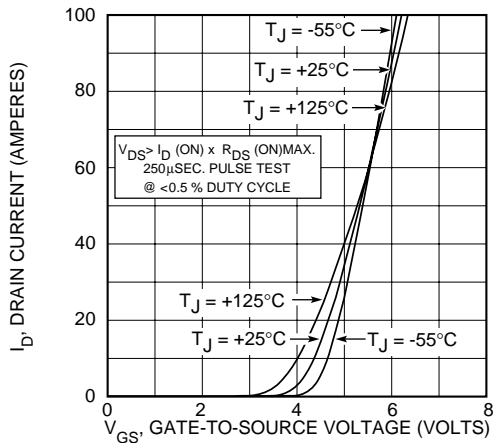

FIGURE 4, TYPICAL TRANSFER CHARACTERISTICS

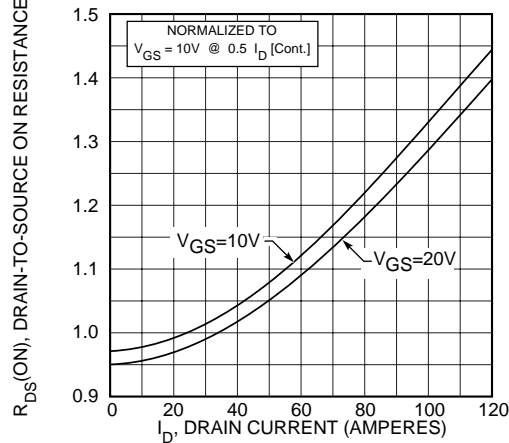

FIGURE 5, $R_{DS(ON)}$ vs DRAIN CURRENT

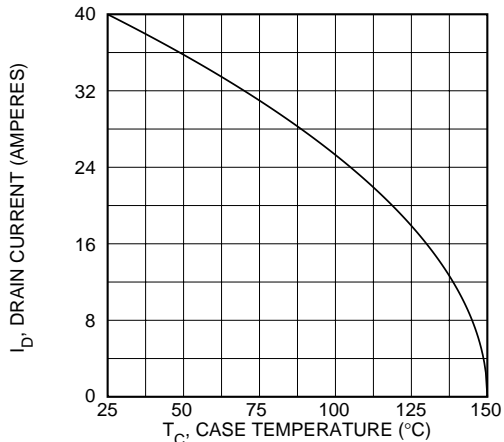

FIGURE 6, MAXIMUM DRAIN CURRENT vs CASE TEMPERATURE

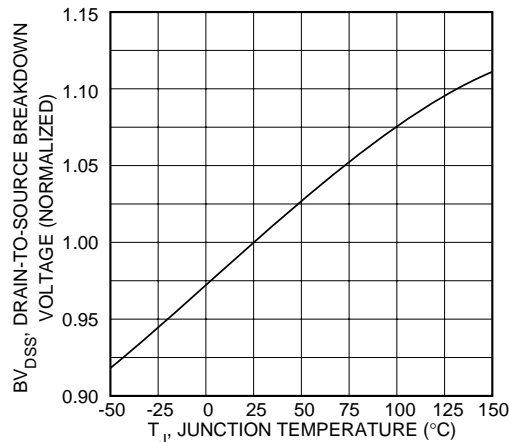

FIGURE 7, BREAKDOWN VOLTAGE vs TEMPERATURE

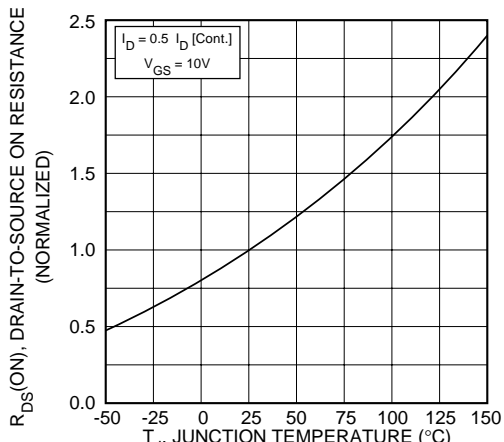

FIGURE 8, ON-RESISTANCE vs. TEMPERATURE

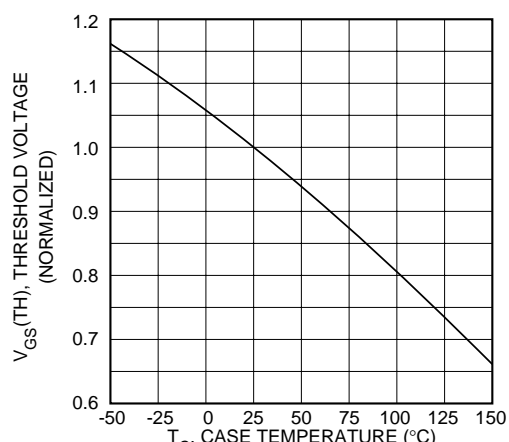

FIGURE 9, THRESHOLD VOLTAGE vs TEMPERATURE

APT5012WVR

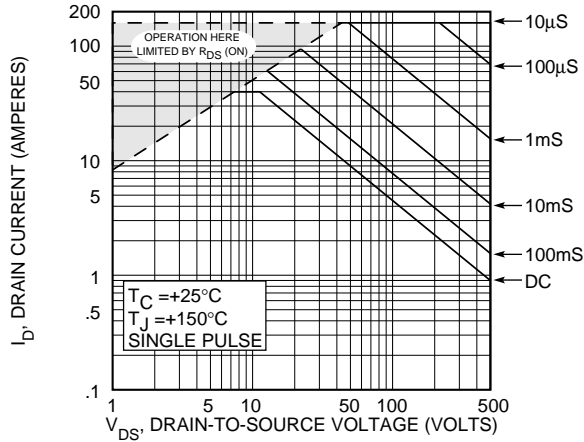

FIGURE 10, MAXIMUM SAFE OPERATING AREA

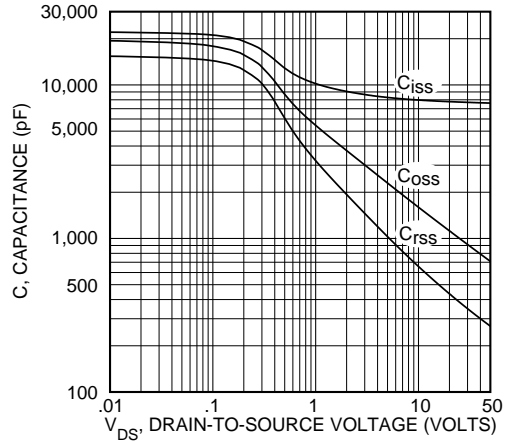

FIGURE 11, TYPICAL CAPACITANCE vs DRAIN-TO-SOURCE VOLTAGE

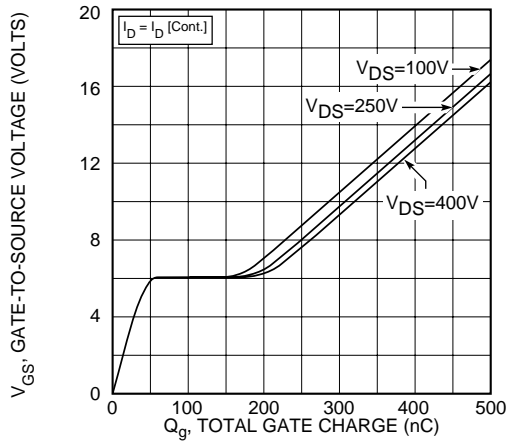

FIGURE 12, GATE CHARGES vs GATE-TO-SOURCE VOLTAGE

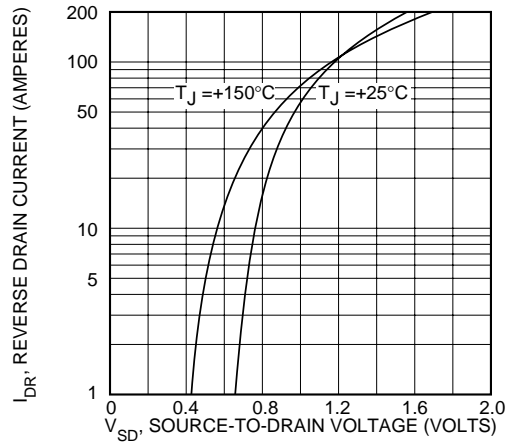
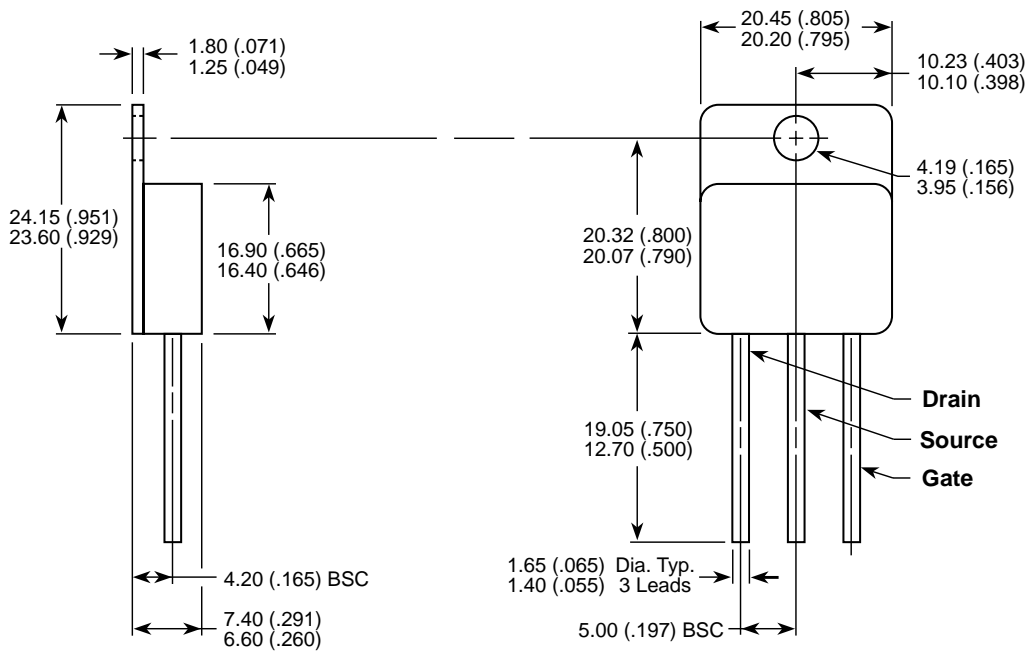

FIGURE 13, TYPICAL SOURCE-DRAIN DIODE FORWARD VOLTAGE

TO-267 Package Outline



Dimensions in Millimeters and (Inches)