



APT6035BVFR APT6035SVFR

600V 18A 0.350Ω

POWER MOS V[®] FREDFET

Power MOS V[®] is a new generation of high voltage N-Channel enhancement mode power MOSFETs. This new technology minimizes the JFET effect, increases packing density and reduces the on-resistance. Power MOS V[®] also achieves faster switching speeds through optimized gate layout.

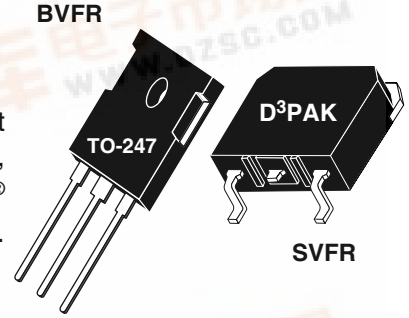

- **Faster Switching**
- **Avalanche Energy Rated**
- **Lower Leakage**
- **FAST RECOVERY BODY DIODE**
- **TO-247 or Surface Mount D³PAK Package**

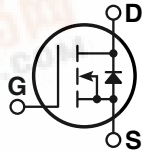

MAXIMUM RATINGS

All Ratings: $T_C = 25^\circ\text{C}$ unless otherwise specified.

Symbol	Parameter	APT6035BVFR_SVFR	UNIT
V_{DSS}	Drain-Source Voltage	600	Volts
I_D	Continuous Drain Current @ $T_C = 25^\circ\text{C}$	18	Amps
I_{DM}	Pulsed Drain Current ^①	72	
V_{GS}	Gate-Source Voltage Continuous	± 30	Volts
V_{GSM}	Gate-Source Voltage Transient	± 40	
P_D	Total Power Dissipation @ $T_C = 25^\circ\text{C}$	280	Watts
	Linear Derating Factor	2.24	W/ $^\circ\text{C}$
T_J, T_{STG}	Operating and Storage Junction Temperature Range	-55 to 150	$^\circ\text{C}$
T_L	Lead Temperature: 0.063" from Case for 10 Sec.	300	
I_{AR}	Avalanche Current ^① (Repetitive and Non-Repetitive)	18	Amps
E_{AR}	Repetitive Avalanche Energy ^①	30	mJ
E_{AS}	Single Pulse Avalanche Energy ^④	1210	

STATIC ELECTRICAL CHARACTERISTICS

Symbol	Characteristic / Test Conditions	MIN	TYP	MAX	UNIT
BV_{DSS}	Drain-Source Breakdown Voltage ($V_{GS} = 0V, I_D = 250\mu\text{A}$)	600			Volts
$R_{DS(on)}$	Drain-Source On-State Resistance ^② ($V_{GS} = 10V, I_D = 9A$)			0.350	Ohms
I_{DSS}	Zero Gate Voltage Drain Current ($V_{DS} = 600V, V_{GS} = 0V$)			250	μA
	Zero Gate Voltage Drain Current ($V_{DS} = 480V, V_{GS} = 0V, T_C = 125^\circ\text{C}$)			1000	
I_{GSS}	Gate-Source Leakage Current ($V_{GS} = \pm 30V, V_{DS} = 0V$)			± 100	nA
$V_{GS(th)}$	Gate Threshold Voltage ($V_{DS} = V_{GS}, I_D = 1\text{mA}$)	2		4	Volts

CAUTION: These Devices are Sensitive to Electrostatic Discharge. Proper Handling Procedures Should Be Followed.

DYNAMIC CHARACTERISTICS

APT6035BVFR_SVFR

Symbol	Characteristic	Test Conditions	MIN	TYP	MAX	UNIT
C_{iss}	Input Capacitance	$V_{GS} = 0V$ $V_{DS} = 25V$ $f = 1\text{ MHz}$		3450	4140	pF
C_{oss}	Output Capacitance			403	565	
C_{rss}	Reverse Transfer Capacitance			155	235	
Q_g	Total Gate Charge ③	$V_{GS} = 10V$ $V_{DD} = 300V$ $I_D = 18A @ 25^\circ C$		140	210	nC
Q_{gs}	Gate-Source Charge			19	30	
Q_{gd}	Gate-Drain ("Miller") Charge			68	100	
$t_{d(on)}$	Turn-on Delay Time	$V_{GS} = 15V$ $V_{DD} = 300V$ $I_D = 18A @ 25^\circ C$ $R_G = 1.6\Omega$		12	24	ns
t_r	Rise Time			12	24	
$t_{d(off)}$	Turn-off Delay Time			40	60	
t_f	Fall Time			8	16	

SOURCE-DRAIN DIODE RATINGS AND CHARACTERISTICS

Symbol	Characteristic / Test Conditions	MIN	TYP	MAX	UNIT
I_S	Continuous Source Current (Body Diode)			18	Amps
I_{SM}	Pulsed Source Current ① (Body Diode)			72	
V_{SD}	Diode Forward Voltage ② ($V_{GS} = 0V, I_S = -18A$)			1.3	Volts
dv/dt	Peak Diode Recovery dv/dt ⑤			15	V/ns
t_{rr}	Reverse Recovery Time ($I_S = -18A, di/dt = 100A/\mu s$)	$T_j = 25^\circ C$		250	ns
		$T_j = 125^\circ C$		500	
Q_{rr}	Reverse Recovery Charge ($I_S = -18A, di/dt = 100A/\mu s$)	$T_j = 25^\circ C$	1.8		μC
		$T_j = 125^\circ C$	5.2		
I_{RRM}	Peak Recovery Current ($I_S = -18A, di/dt = 100A/\mu s$)	$T_j = 25^\circ C$	11		Amps
		$T_j = 125^\circ C$	18		

THERMAL CHARACTERISTICS

Symbol	Characteristic	MIN	TYP	MAX	UNIT
$R_{\theta JC}$	Junction to Case			0.45	$^\circ C/W$
$R_{\theta JA}$	Junction to Ambient			40	

① Repetitive Rating: Pulse width limited by maximum junction temperature

② Pulse Test: Pulse width < 380 μs , Duty Cycle < 2%

③ See MIL-STD-750 Method 3471

④ Starting $T_j = +25^\circ C$, $L = 7.47mH$, $R_G = 25\Omega$, Peak $I_L = 18A$

⑤ dv/dt numbers reflect the limitations of the test circuit rather than the device itself. $I_S \leq -I_D 18A$ $di/dt \leq 700A/\mu s$ $V_R \leq 600V$ $T_j \leq 150^\circ C$

APT Reserves the right to change, without notice, the specifications and information contained herein.

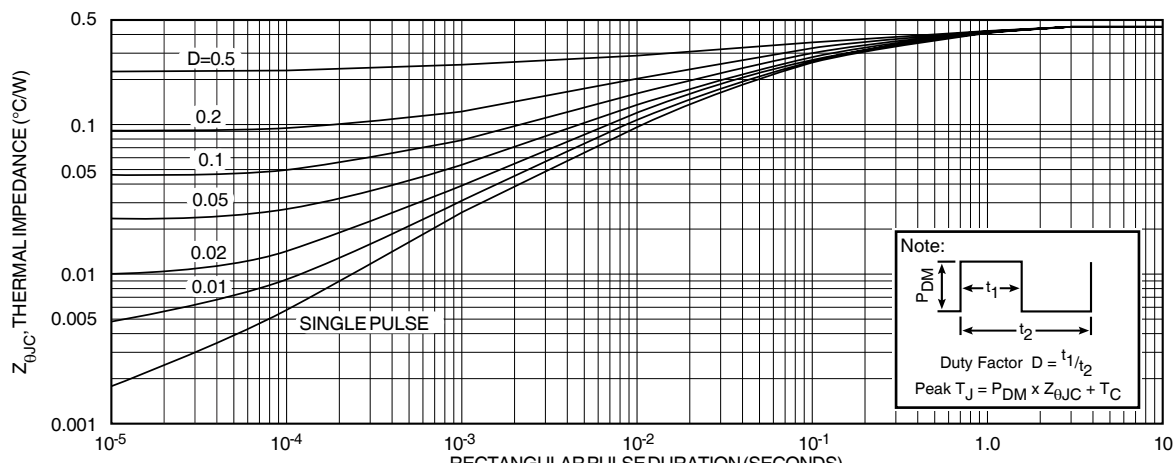

Typical Performance Curves

APT6035BVFR_SVFR

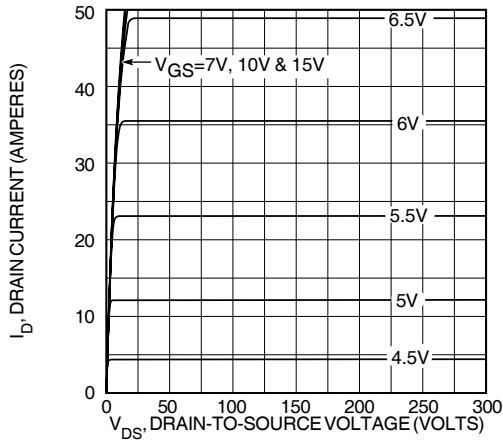

FIGURE 2, TYPICAL OUTPUT CHARACTERISTICS

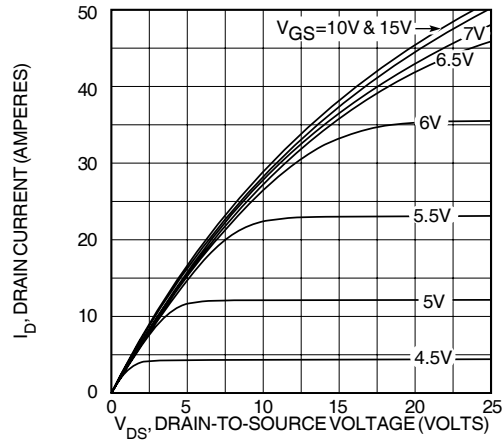

FIGURE 3, TYPICAL OUTPUT CHARACTERISTICS

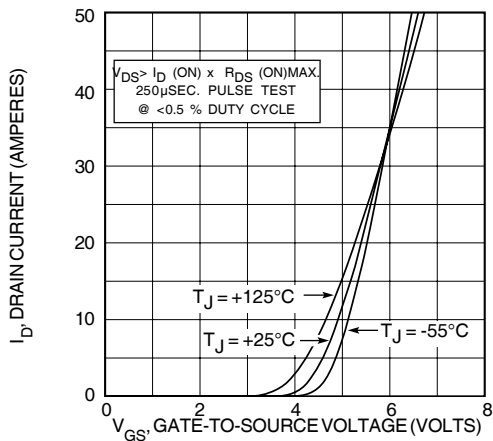

FIGURE 4, TYPICAL TRANSFER CHARACTERISTICS

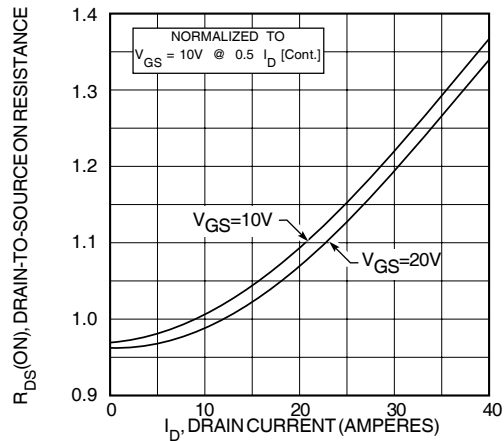

FIGURE 5, $R_{DS(ON)}$ vs DRAIN CURRENT

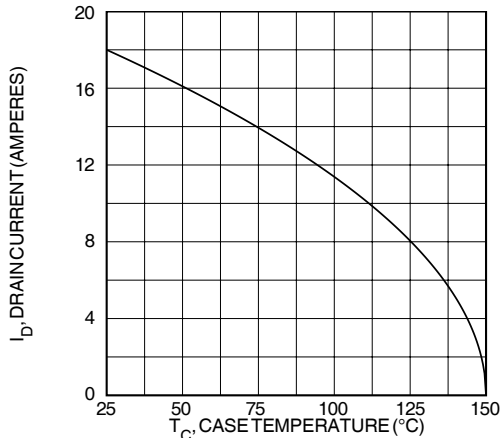

FIGURE 6, MAXIMUM DRAIN CURRENT vs CASE TEMPERATURE

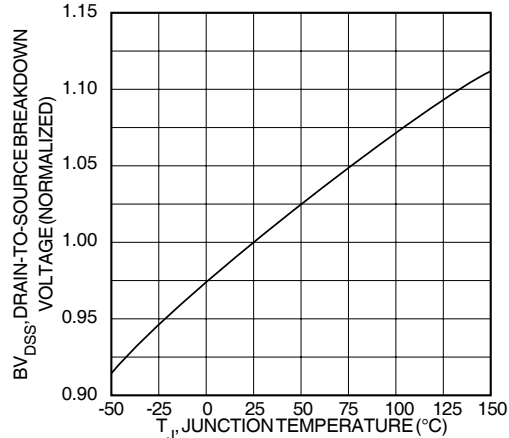

FIGURE 7, BREAKDOWN VOLTAGE vs TEMPERATURE

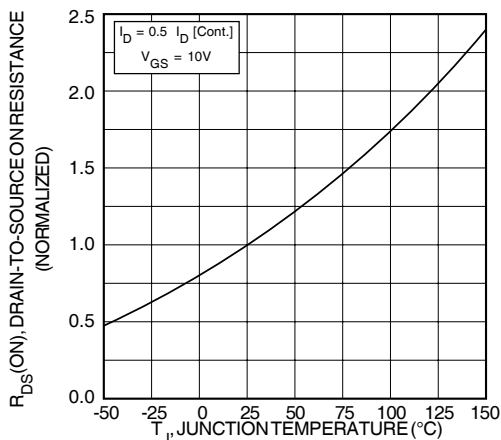

FIGURE 8, ON-RESISTANCE vs. TEMPERATURE

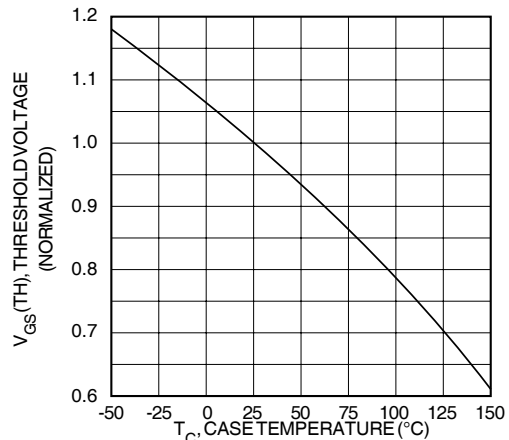

FIGURE 9, THRESHOLD VOLTAGE vs TEMPERATURE

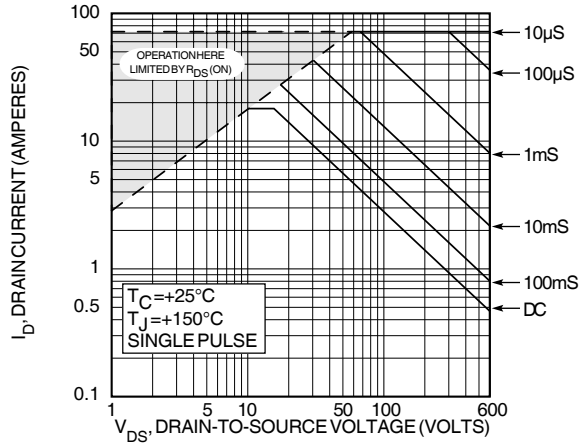

FIGURE 10, MAXIMUM SAFE OPERATING AREA

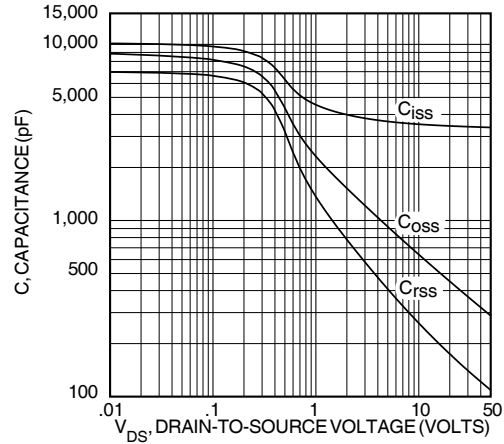

FIGURE 11, TYPICAL CAPACITANCE vs DRAIN-TO-SOURCE VOLTAGE

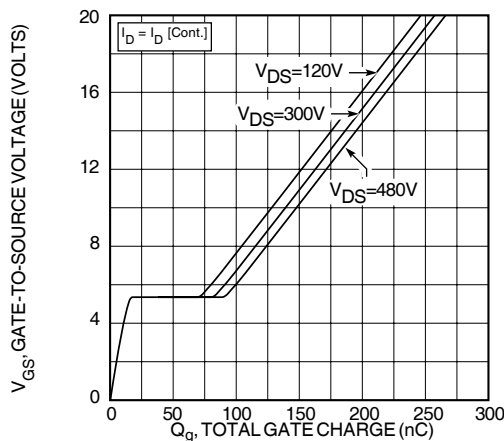

FIGURE 12, GATE CHARGES vs GATE-TO-SOURCE VOLTAGE

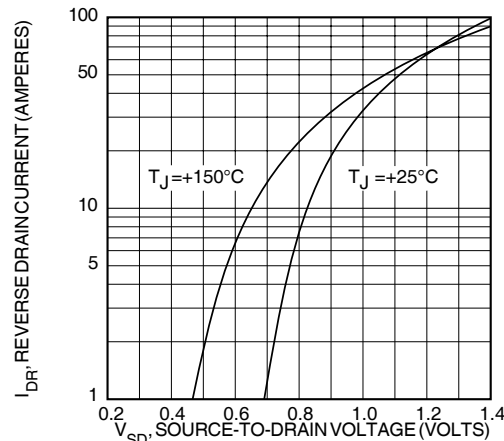
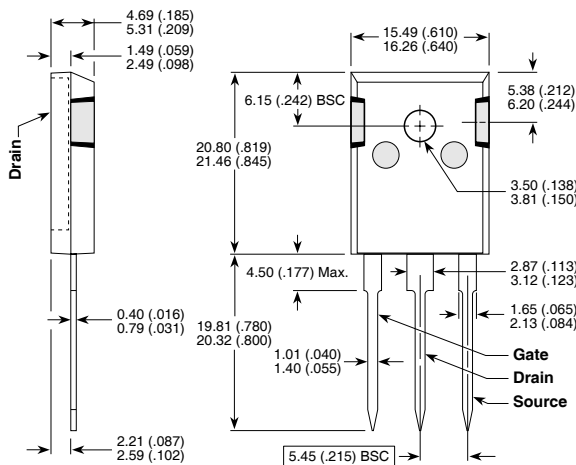

FIGURE 13, TYPICAL SOURCE-DRAIN DIODE FORWARD VOLTAGE

TO-247 Package Outline (BVFR)



Dimensions in Millimeters (Inches)

D³PAK Package Outline (SVFR)

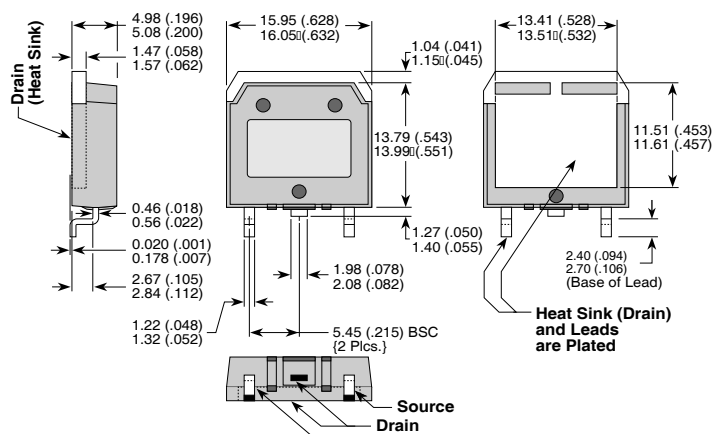

Dimensions in Millimeters (Inches)