



1200V 2x60A
APT60DQ120LCT
APT60DQ120LCTG*

*G Denotes RoHS Compliant, Pb Free Terminal Finish.

ULTRAFAST SOFT RECOVERY RECTIFIER DIODE

PRODUCT APPLICATIONS

- Anti-Parallel Diode
 - Switchmode Power Supply
 - Inverters
- Free Wheeling Diode
 - Motor Controllers
 - Converters
 - Inverters
- Snubber Diode
- PFC

PRODUCT FEATURES

- Ultrafast Recovery Times
- Soft Recovery Characteristics
- Popular TO-264 Package
- Low Forward Voltage
- Low Leakage Current
- Avalanche Energy Rated

PRODUCT BENEFITS

- Low Losses
- Low Noise Switching
- Cooler Operation
- Higher Reliability Systems
- Increased System Power Density

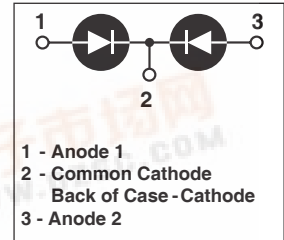
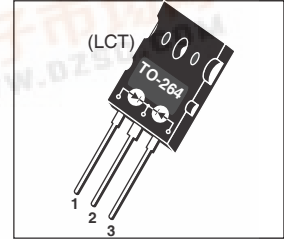

MAXIMUM RATINGS

All Ratings Per Leg: $T_C = 25^\circ\text{C}$ unless otherwise specified.

| Symbol | Characteristic / Test Conditions | APT60DQ120LCT(G) | UNIT |
|----------------|---|------------------|------------------|
| V_R | Maximum D.C. Reverse Voltage | 1200 | Volts |
| V_{RRM} | Maximum Peak Repetitive Reverse Voltage | | |
| V_{RWM} | Maximum Working Peak Reverse Voltage | | |
| $I_{F(AV)}$ | Maximum Average Forward Current ($T_C = 103^\circ\text{C}$, Duty Cycle = 0.5) | 60 | Amps |
| $I_{F(RMS)}$ | RMS Forward Current (Square wave, 50% duty) | 87 | |
| I_{FSM} | Non-Repetitive Forward Surge Current ($T_J = 45^\circ\text{C}$, 8.3ms) | 540 | |
| E_{AVL} | Avalanche Energy (1A, 40mH) | 20 | mJ |
| T_J, T_{STG} | Operating and Storage Temperature Range | -55 to 175 | $^\circ\text{C}$ |
| T_L | Lead Temperature for 10 Sec. | 300 | |

STATIC ELECTRICAL CHARACTERISTICS

| Symbol | Characteristic / Test Conditions | MIN | TYP | MAX | UNIT |
|----------|---|---|------|-----|---------------|
| V_F | Forward Voltage | $I_F = 60\text{A}$ | 2.8 | 3.3 | Volts |
| | | $I_F = 120\text{A}$ | 3.35 | | |
| | | $I_F = 60\text{A}, T_J = 125^\circ\text{C}$ | 2.11 | | |
| I_{RM} | Maximum Reverse Leakage Current | $V_R = 1200\text{V}$ | | 100 | μA |
| | | $V_R = 1200\text{V}, T_J = 125^\circ\text{C}$ | | 500 | |
| C_j | Junction Capacitance, $V_R = 200\text{V}$ | | 37 | | pF |

DYNAMIC CHARACTERISTICS

APT60DQ120LCT(G)

| Symbol | Characteristic | Test Conditions | MIN | TYP | MAX | UNIT |
|-----------|----------------------------------|--|-----|------|-----|------|
| t_{rr} | Reverse Recovery Time | $I_F = 1A, di_F/dt = -100A/\mu s, V_R = 30V, T_J = 25^\circ C$ | - | 30 | | ns |
| t_{rr} | Reverse Recovery Time | | - | 320 | | |
| Q_{rr} | Reverse Recovery Charge | $I_F = 60A, di_F/dt = -200A/\mu s, V_R = 800V, T_C = 25^\circ C$ | - | 630 | | nC |
| I_{RRM} | Maximum Reverse Recovery Current | | - | 5 | - | Amps |
| t_{rr} | Reverse Recovery Time | | - | 420 | | ns |
| Q_{rr} | Reverse Recovery Charge | $I_F = 60A, di_F/dt = -200A/\mu s, V_R = 800V, T_C = 125^\circ C$ | - | 2810 | | nC |
| I_{RRM} | Maximum Reverse Recovery Current | | - | 12 | - | Amps |
| t_{rr} | Reverse Recovery Time | | - | 190 | | ns |
| Q_{rr} | Reverse Recovery Charge | $I_F = 60A, di_F/dt = -1000A/\mu s, V_R = 800V, T_C = 125^\circ C$ | - | 4415 | | nC |
| I_{RRM} | Maximum Reverse Recovery Current | | - | 38 | | Amps |

THERMAL AND MECHANICAL CHARACTERISTICS

| Symbol | Characteristic / Test Conditions | MIN | TYP | MAX | UNIT |
|-----------------|-------------------------------------|-----|------|-----|--------------|
| $R_{\theta JC}$ | Junction-to-Case Thermal Resistance | | | .40 | $^\circ C/W$ |
| W_T | Package Weight | | 0.22 | | oz |
| | | | 5.9 | | g |
| Torque | Maximum Mounting Torque | | | 10 | lb•in |
| | | | | 1.1 | N•m |

APT Reserves the right to change, without notice, the specifications and information contained herein.

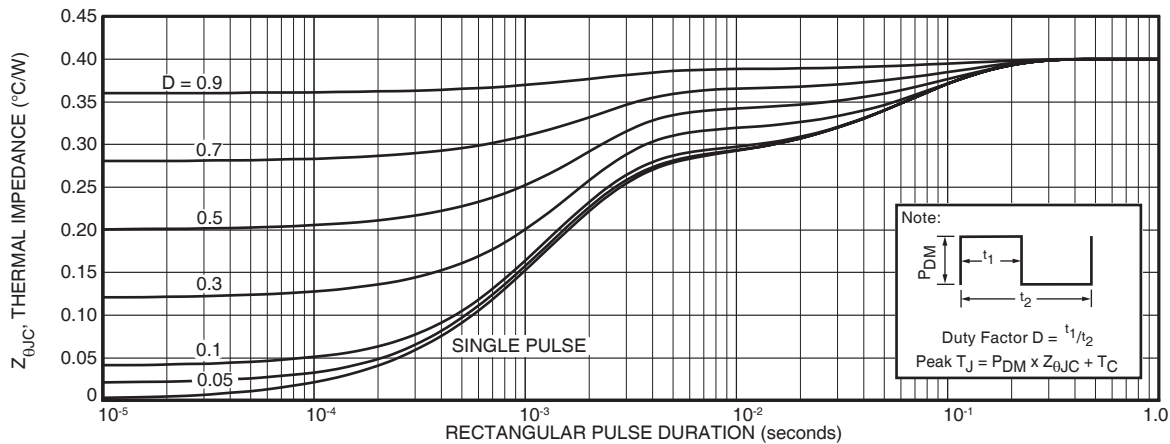

FIGURE 1a. MAXIMUM EFFECTIVE TRANSIENT THERMAL IMPEDANCE, JUNCTION-TO-CASE vs. PULSE DURATION

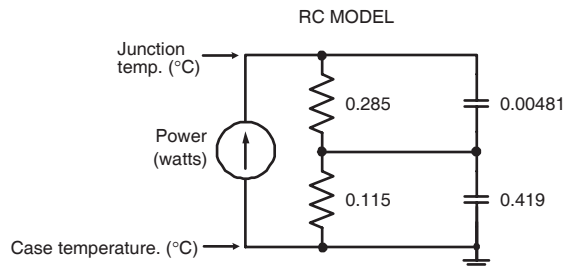

FIGURE 1b. TRANSIENT THERMAL IMPEDANCE MODEL

TYPICAL PERFORMANCE CURVES

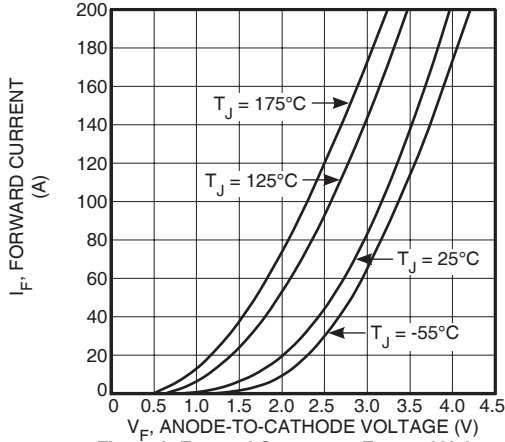

Figure 2. Forward Current vs. Forward Voltage

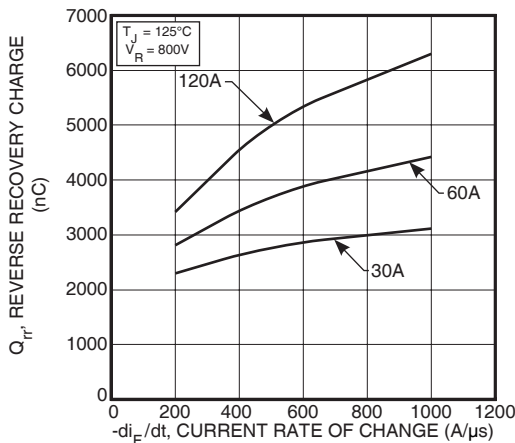

Figure 4. Reverse Recovery Charge vs. Current Rate of Change

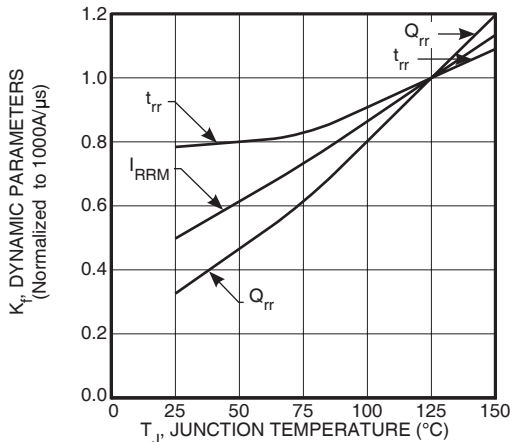

Figure 6. Dynamic Parameters vs. Junction Temperature

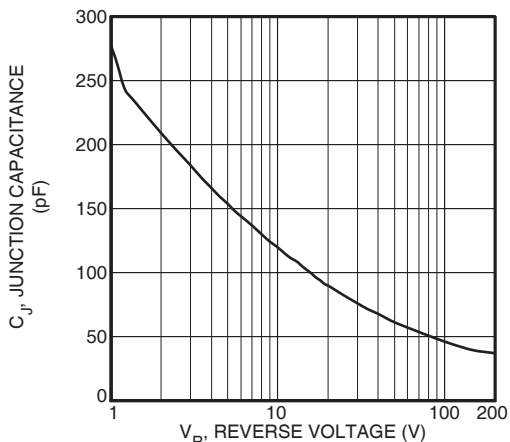

Figure 8. Junction Capacitance vs. Reverse Voltage

APT60DQ120LCT(G)

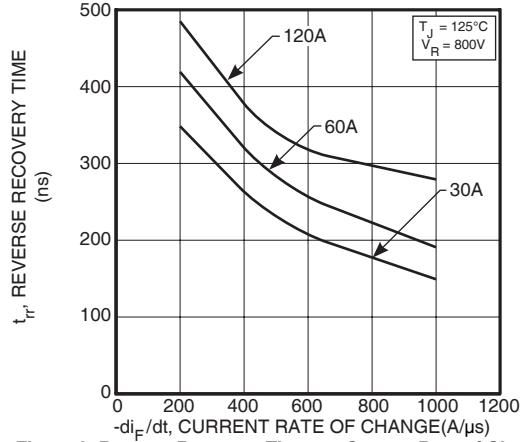

Figure 3. Reverse Recovery Time vs. Current Rate of Change

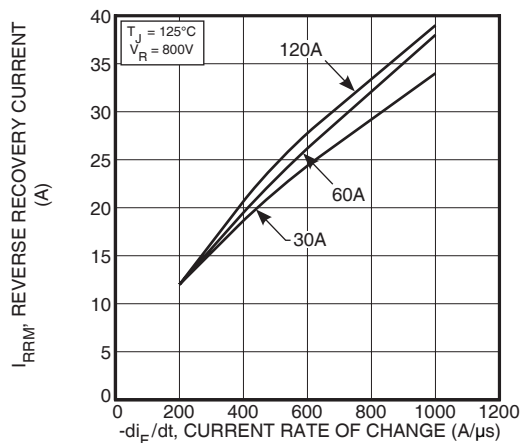

Figure 5. Reverse Recovery Current vs. Current Rate of Change

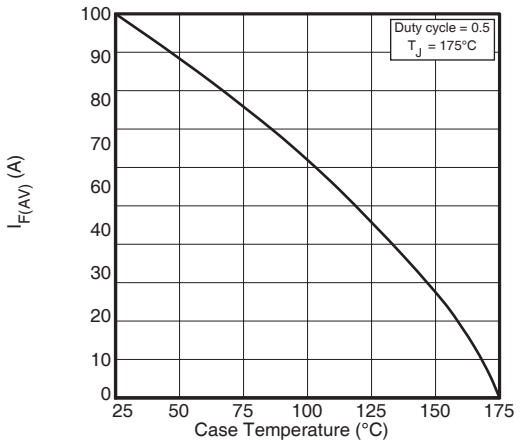

Figure 7. Maximum Average Forward Current vs. Case Temperature

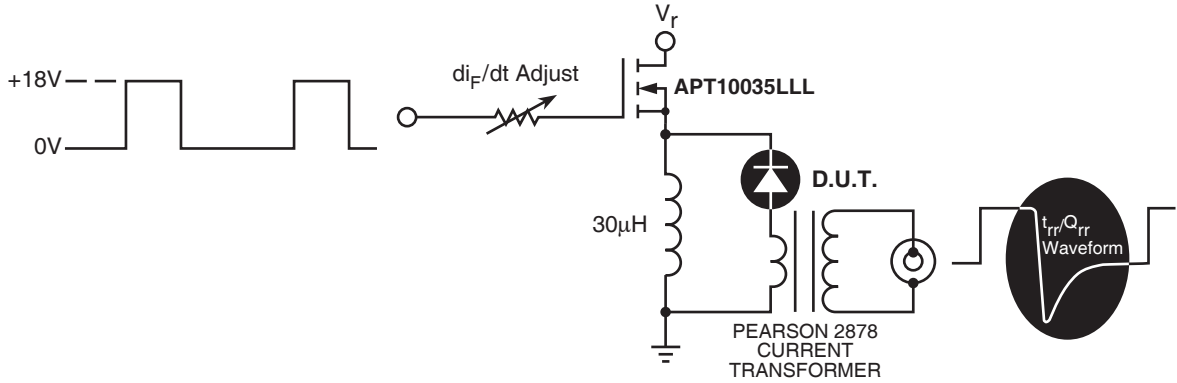

Figure 9. Diode Test Circuit

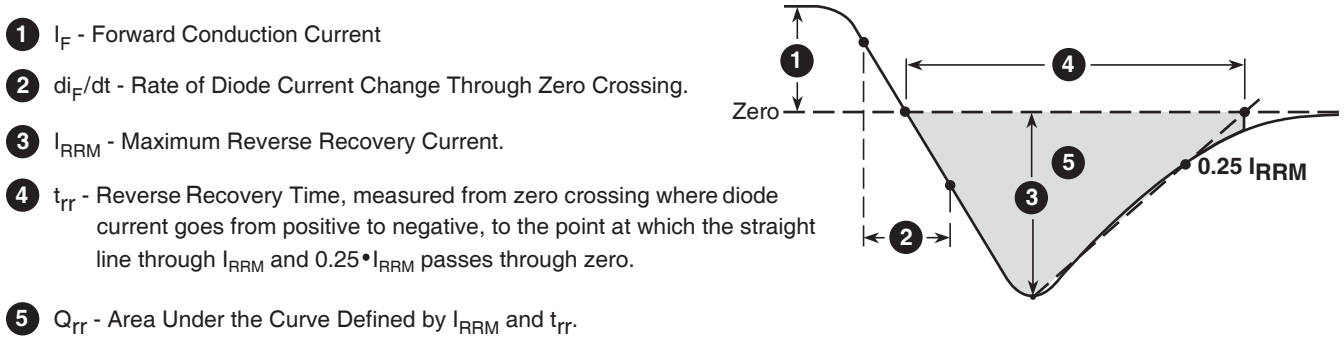

Figure 10, Diode Reverse Recovery Waveform and Definitions

TO-264 (LCT) Package Outline

