

# APW7062A



## Synchronous Buck PWM Controller

### Features

- Simple Single-Loop Control Design
  - Voltage-Mode PWM Control
- Fast Transient Response
  - Full 0–100% Duty Ratio
- Excellent Output Voltage Regulation
  - 0.8V Internal Reference
  - $\pm 1\%$  Over Line Voltage and Temperature
- Over Current Fault Monitor
  - Uses Upper MOSFETs  $R_{DS(ON)}$
- Converter Can Source and Sink Current
- Small Converter Size
  - 200kHz Free-Running Oscillator
  - Programmable from 70kHz to 800kHz
- 14-Lead SOIC Package
- Lead Free Available (RoHS Compliant)

### Applications

- Graphic Cards
- DDR Memory Power Supply
- DDR Memory Termination Voltage
- Low-Voltage Distributed Power Supplies

### General Description

The APW7062A is a voltage mode, synchronous PWM controller which drives dual N-Channel MOSFETs. It integrates the control, monitoring and protection functions into a single package, provides one controlled power outputs with under-voltage and over-current protection.

APW7062A provide excellent regulation for output load variation. An internal 0.8V temperature-compensated reference voltage is designed to meet the requirement of low output voltage applications. It includes a 200kHz free-running triangle-wave oscillator that is adjustable from 70kHz to 800kHz.

The power-on-reset (POR) circuit monitors the VCC, EN, OCSET input voltage to start-up or shutdown the IC. The over-current protection (OCP) monitors the output current by using the voltage drop across the upper MOSFET's  $R_{DS(ON)}$ , eliminating the need for a current sensing resistor. The under-voltage protection (UVP) monitors the voltage of FB pin for short-circuit protection.

The over-current protection trip cycle the soft-start function until the fault events be removed. Under-voltage protection will shutdown the IC directly.

### Pinouts

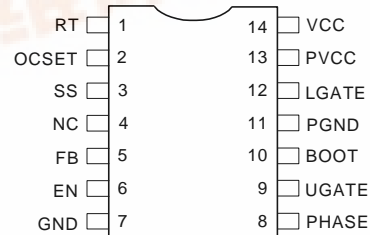

## Ordering and Marking Information

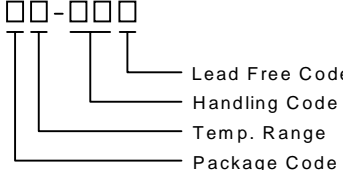
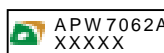
<p>APW7062A</p>  <p>Lead Free Code Handling Code Temp. Range Package Code</p>	<p>Package Code K : SOP-14 Operating Junction Temp. Range C : 0 to 70°C Handling Code TU : Tube      TR : Tape &amp; Reel Lead Free Code L : Lead Free Device      Blank : Original Device</p>
<p>APW7062A K :</p> 	<p>XXXXX - Date Code</p>

Notes : ANPEC lead-free products contain molding compounds/die attach materials and 100% matte in plate termination finish; which are fully compliant with RoHS and compatible with both SnPb and lead-free soldering operations. ANPEC lead-free products meet or exceed the lead-free requirements of IPC/JEDEC J STD-020C for MSL classification at lead-free peak reflow temperature.

## Block Diagram

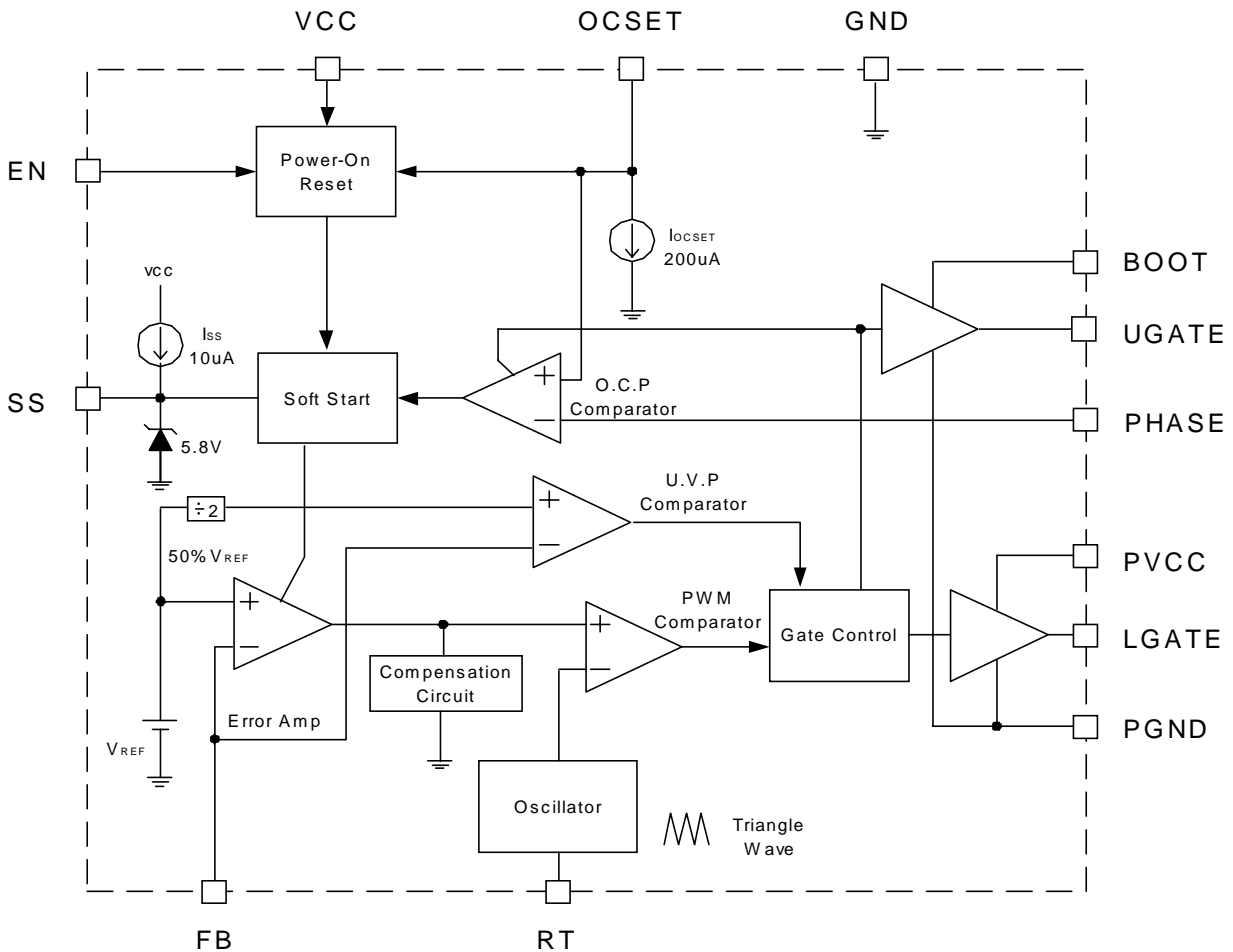

## Application Circuit

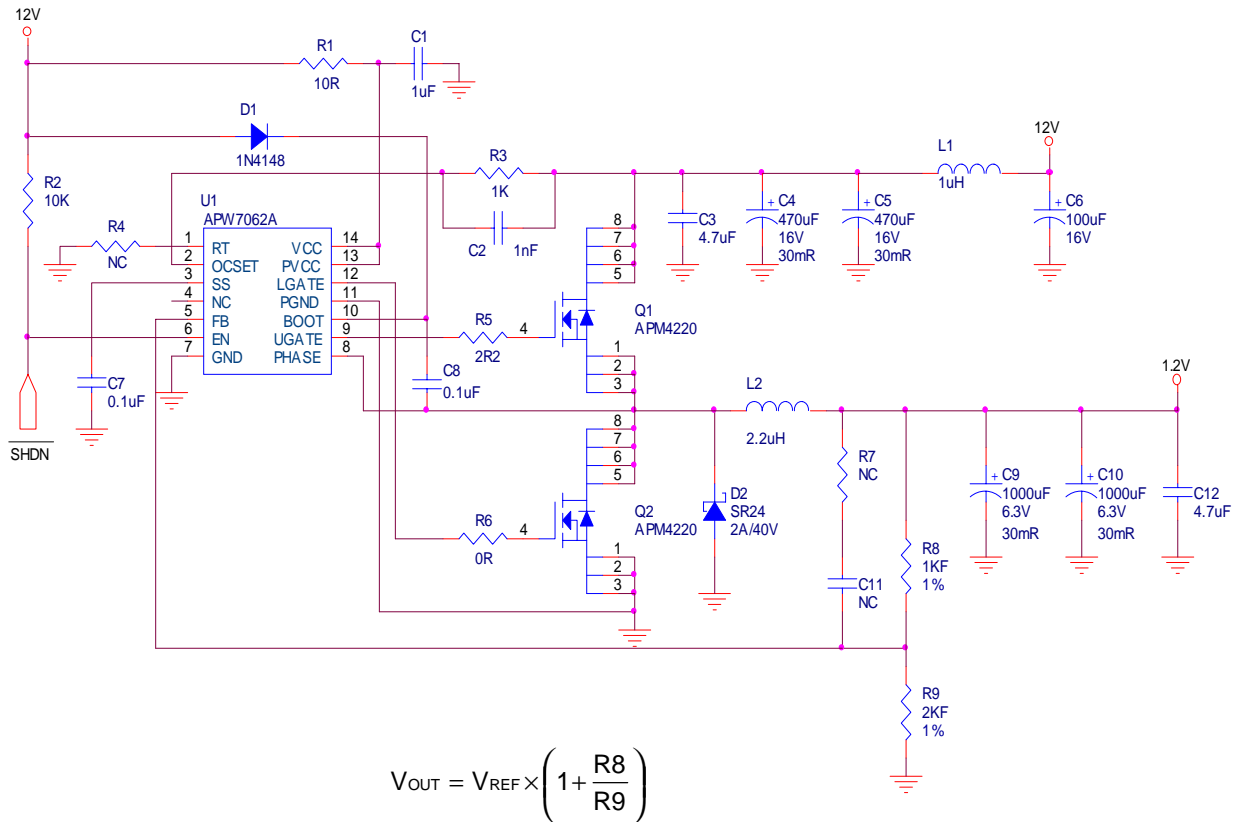

## Absolute Maximum Ratings

Symbol	Parameter	Rating	Unit
V <sub>CC</sub>	VCC to GND	30	V
V <sub>BOOT</sub>	BOOT to GND	30	V
V <sub>PHASE</sub>	PHASE to GND	30	V
	Operating Junction Temperature	0~150	°C
T <sub>STG</sub>	Storage Temperature	-65 ~ 150	°C
T <sub>SDR</sub>	Soldering Temperature (10 Seconds)	300	°C
V <sub>ESD</sub>	Minimum ESD Rating	±2	KV

## Electrical Characteristics

Symbol	Parameter	Test Conditions	APW7062A			Unit
			Min	Typ	Max	
<b>V<sub>CC</sub> SUPPLY CURRENT</b>						
I <sub>CC</sub>	Nominal Supply	EN=V <sub>CC</sub> ; UGATE and LGATE Open		2		mA
	Shutdown Supply	EN=0V		250	350	μA
<b>POWER-ON-RESET</b>						
	Rising V <sub>CC</sub> Threshold	V <sub>OCSET</sub> =4.5V <sub>DC</sub>			10.4	V
	Falling V <sub>CC</sub> Threshold	V <sub>OCSET</sub> =4.5V <sub>DC</sub>	8.8			V
	Enable-Input Threshold Voltage	V <sub>OCSET</sub> =4.5V <sub>DC</sub>	0.8		2.0	V
	Rising V <sub>OCSET</sub> Threshold			1.27		V
<b>OSCILLATOR</b>						
	Free Running Frequency	R <sub>T</sub> =OPEN, V <sub>CC</sub> =12	170	200	230	kHz
	Total Variation	6KΩ < R <sub>T</sub> to GND < 200KΩ	-15		+15	%
ΔV <sub>OSC</sub>	Ramp Amplitude	R <sub>T</sub> =OPEN		1.9		V <sub>P-P</sub>
<b>REFERENCE VOLTAGE ACCURANCY</b>						
ΔV <sub>REF</sub>	Reference Voltage Tolerance		-1		+1	%
V <sub>REF</sub>	Reference Voltage			0.80		V
<b>GATE DRIVERS</b>						
I <sub>UGATE</sub>	Upper Gate Source	V <sub>BOOT</sub> =12V, V <sub>UGATE</sub> =6V	650	800		mA
R <sub>UGATE</sub>	Upper Gate Sink	I <sub>UGATE</sub> =0.3A		4	7	Ω
I <sub>LGATE</sub>	Lower Gate Source	P <sub>VCC</sub> =12V, V <sub>LGATE</sub> =6V	550	700		mA
R <sub>LGATE</sub>	Lower Gate Sink	I <sub>LGATE</sub> =0.3A		4	7	Ω
T <sub>D</sub>	Dead Time	V <sub>OUT</sub> =2.5V, I <sub>OUT</sub> =1A, R <sub>T</sub> =OPEN		50		ns
<b>PROTECTION</b>						
	FB Under Voltage			50		%
I <sub>OCSET</sub>	OCSET Current Source	V <sub>OCSET</sub> =4.5V <sub>DC</sub>	170	200	230	μA
I <sub>SS</sub>	Soft-Start Current		8	10	12	μA

## Functional Pin Description

### RT (Pin1)

This pin can adjust the switching frequency. Connect a resistor from RT to GND for increasing the switching frequency:

$$F_s = 200\text{kHz} + \frac{4.15 \times 10^6}{RT}$$

(RT to GND,  $F_s = 200\text{kHz}$  to  $400\text{kHz}$ )

Conversely, connect a resistor from RT to  $V_{CC}$  for decreasing the switching frequency:

$$F_s = 200\text{kHz} - \frac{3.51 \times 10^7}{RT}$$

(RT to  $V_{CC}$ ,  $F_s = 200\text{kHz}$  to  $75\text{kHz}$ )

### OCSET (Pin2)

This pin serves two functions: a shutdown control and the setting of over current limit threshold. Pulling this pin below 1.27V will shutdown the controller, forcing the UGATE and LGATE signals to be at 0V.

A resistor ( $R_{OCSET}$ ) connected between this pin and the drain of the high side MOSFET will determine the over current limit. An internal 200uA current source will flow through this resistor, creating a voltage drop, which will be compared with the voltage across the high side MOSFET. The threshold of the over current limit is therefore given by:

$$I_{PEAK} = \frac{I_{OCSET} (200\mu A) \times R_{OCSET}}{R_{DS(ON)}}$$

To avoid noise interference from switching transient, a delay time is designed in the OCP comparator. The over current protection is active only when the high side MOSFET is turned on longer than 300ns.

### SS (Pin3)

Connect a capacitor from the pin to GND to set the soft-start interval of the converter. An internal 10uA current source charges this capacitor to 5.8V. The SS voltage clamps the error amplifier output, and Figure1 shows the soft-start interval. At  $t_1$ , the SS voltage reaches the valley of the oscillator's triangle wave. The PWM comparator starts to generate a PWM signal to control logic, and the output is rising rapidly. Until the output is in regulation at  $t_2$ , the clamp on the COMP is released. This method provides a rapid and controlled output voltage rise.

When over current protection occurs, the VOUT is shutdown, and re-soft-start again, if the over current condition still exists in soft-start, the VOUT is shutdown again, after the SS reaches 4.5V, the SS is discharged to zero. The soft-start is recurring until the over current condition is eliminated.

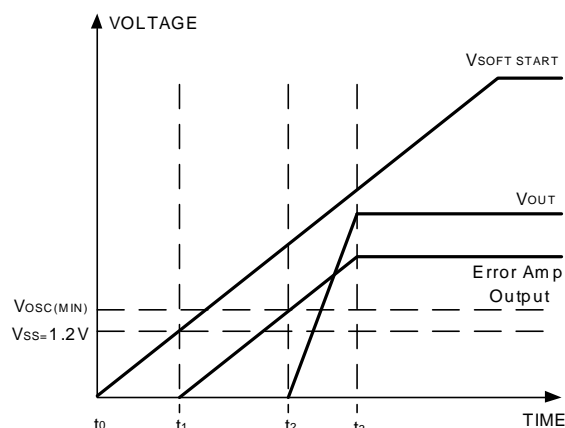

FIGURE1. SOFT-START INTERVAL

$$t_2 = \frac{C_{SS}}{I_{SS}} \times (V_{OSC(MIN)} + t_1)$$

$$t_{SoftStart} = t_3 - t_2 = \frac{C_{SS}}{I_{SS}} \times \frac{V_{OUT SteadyState}}{V_{IN}} \times \Delta V_{OSC}$$

## Functional Pin Description (Cont.)

Where :

$$t_1 = 1.2V$$

$C_{SS}$  = Soft Start Capacitor

$I_{SS}$  = Soft Start Current = 10 $\mu$ A

$V_{OSC(MIN)}$  = Bottom of Oscillator = 1.35V

$V_{IN}$  = Input Voltage

$\Delta V_{osc}$  = Peak to Peak Oscillator Voltage = 1.9V

$\Delta V_{OUTSteadyState}$  = Steady State Output Voltage

### NC (Pin4)

No internal connection.

### FB (Pin5)

FB pin is the inverter input of the error amplifier. and it receives the feedback voltage from an external resistive divider across the output ( $V_{OUT}$ ). The output voltage is determined by:

$$V_{OUT} = 0.8V \times \left( 1 + \frac{R_{OUT}}{R_{GND}} \right)$$

where  $R_{OUT}$  is the resistor connected from  $V_{OUT}$  to FB and  $R_{GND}$  is the resistor connected from FB to GND.

If the FB voltage is under 50%  $V_{REF}$ , because of the short circuit or other influence, it will cause the under voltage protection, and the device is shutdown. Remove the error condition and restart the VCC voltage or pull the EN from low to high once, the device can be enabled again.

### EN (Pin6)

Pull the pin higher than 2V to enable the device, and pull the pin lower than 0.8V to shutdown the device. In shutdown, the SS is discharged and the UGATE and LGATE pins are held low. The EN pin is the open-collector, it will not be floating.

### GND (Pin7)

Signal ground for the IC.

### PHASE (Pin8)

This pin is connected to the source of the high-side MOSFET and is used to monitor the voltage drop across the high-side MOSFET for over-current protection.

### UGATE (Pin9)

Connect the pin to external MOSFET, and provides the gate drive for the upper MOSFET.

### BOOT (Pin 10)

This pin provides the supply voltage to the high side MOSFET driver. For driving logic level N-channel MOSFET, a bootstrap circuit can be used to create a suitable driver's supply.

### PGND (Pin11)

Power ground for the gate driver. Connect the lower MOSFET source to this pin.

### LGATE (Pin 12)

Connect the pin to external MOSFET, and provides the gate drive signal for the lower MOSFET.

### PVCC (Pin13)

This pin provides a supply voltage for the lower gate drive, connect it to VCC pin in common use.

### VCC (Pin14)

This pin provides a supply voltage for the device, when VCC is above the rising threshold (10.4V), the device is turned on, conversely, VCC is below the falling threshold (8.8V), the device is turned off.

## Typical Characteristics

Power Up

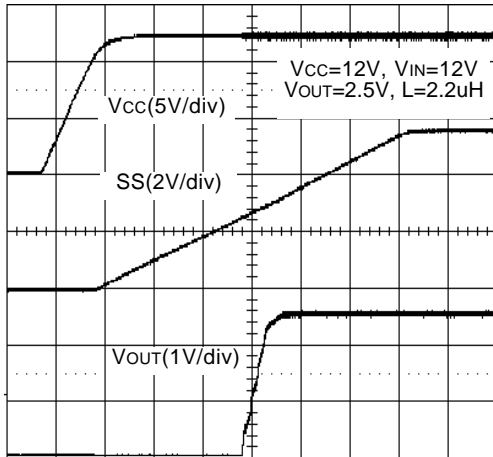

Time(10ms/div)

Power Down

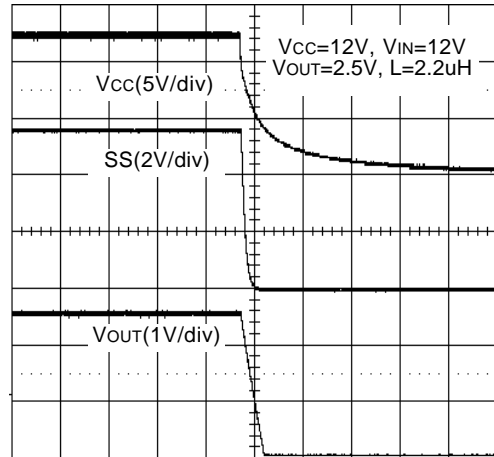

Time(10ms/div)

Enable (EN = V<sub>CC</sub>)

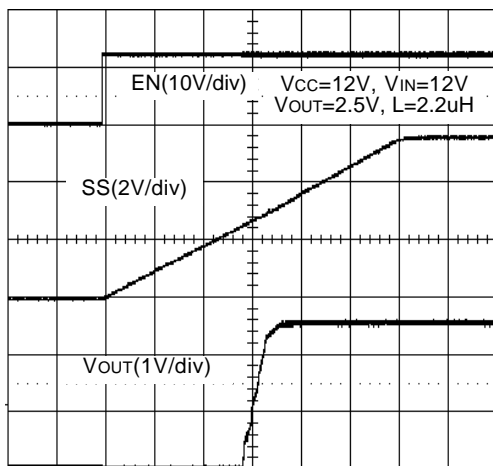

Time(10ms/div)

Shutdown (EN=GND)

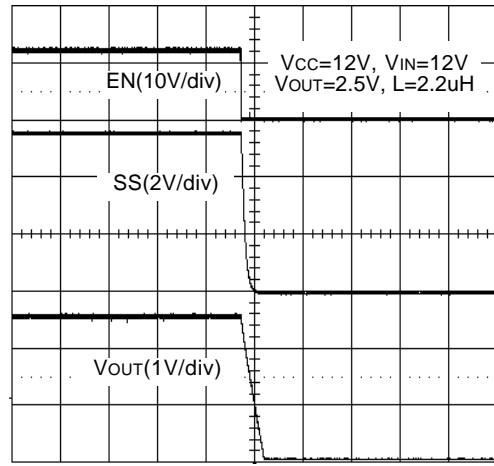

Time(2ms/div)

Typical Characteristics (Cont.)

Load Transient Response

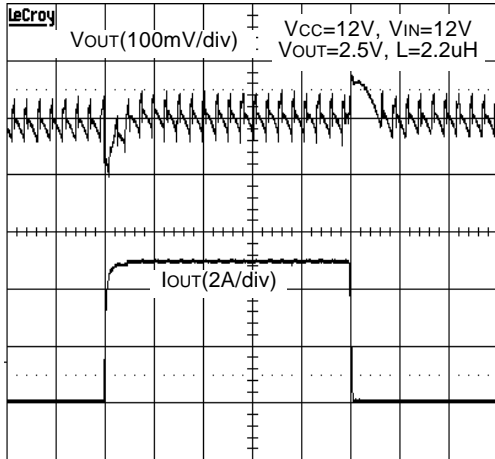

Time(20us/div)

Under Voltage Protection

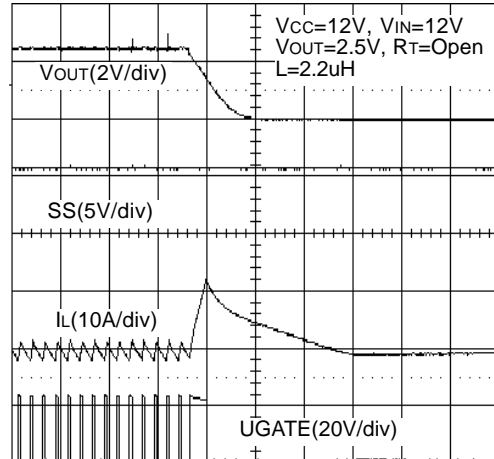

Time(20us/div)

UGATE Rising

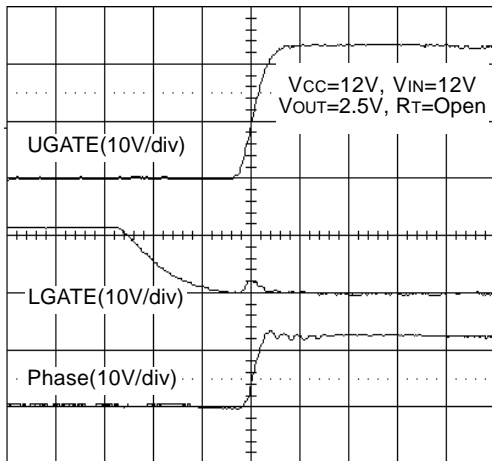

Time(50ns/div)

UGATE Falling

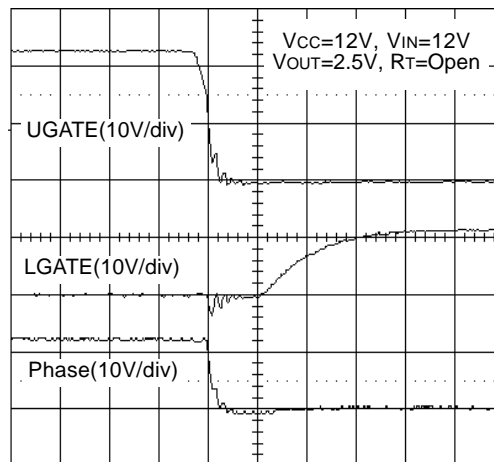

Time(50ns/div)



Typical Characteristics (Cont.)

UGATE Source Current vs. UGATE Voltage

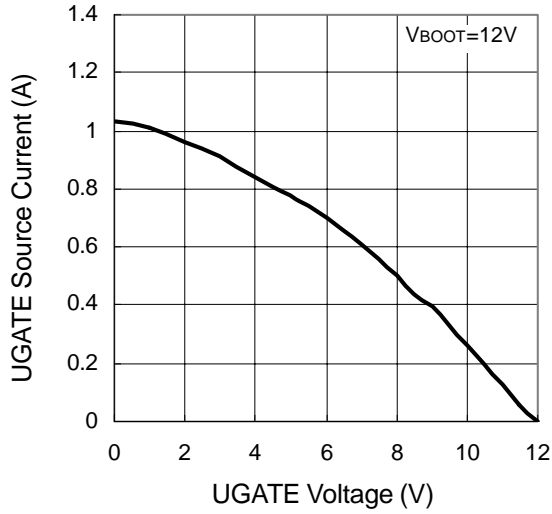

UGATE Sink Current vs. UGATE Voltage

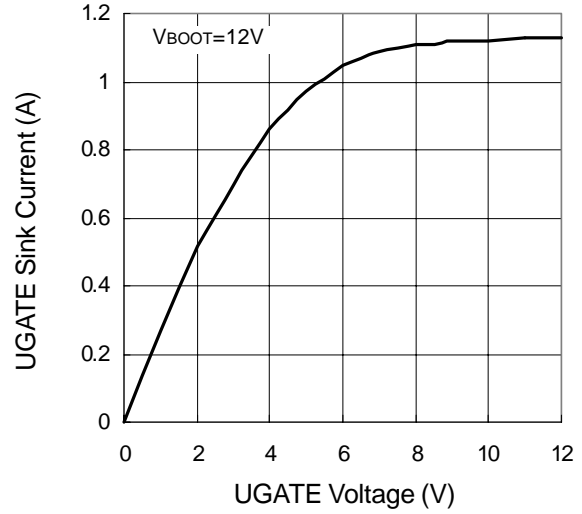

LGATE Source Current vs. LGATE Voltage

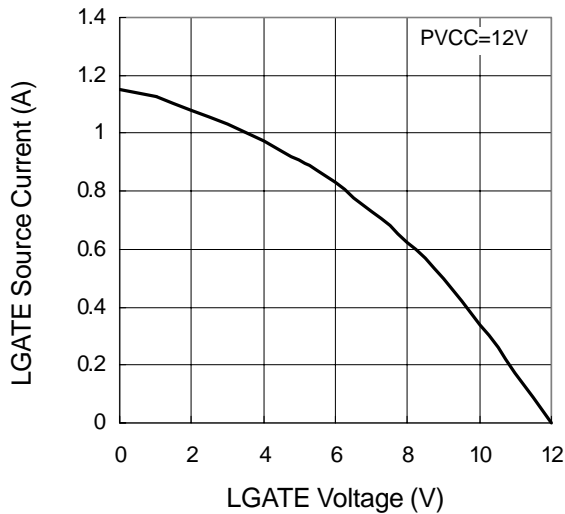

LGATE Sink Current vs. LGATE Voltage

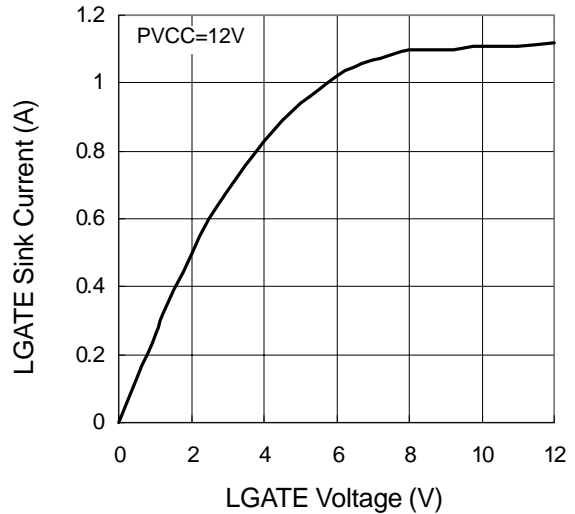

Typical Characteristics (Cont.)

Over Current Protection

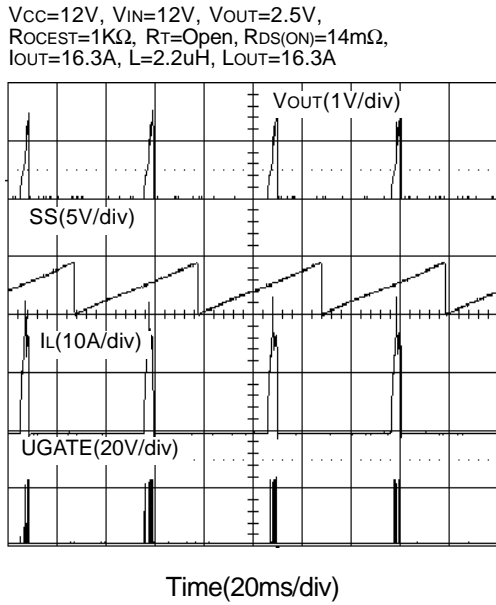

RT Resistance vs. Switching Frequency

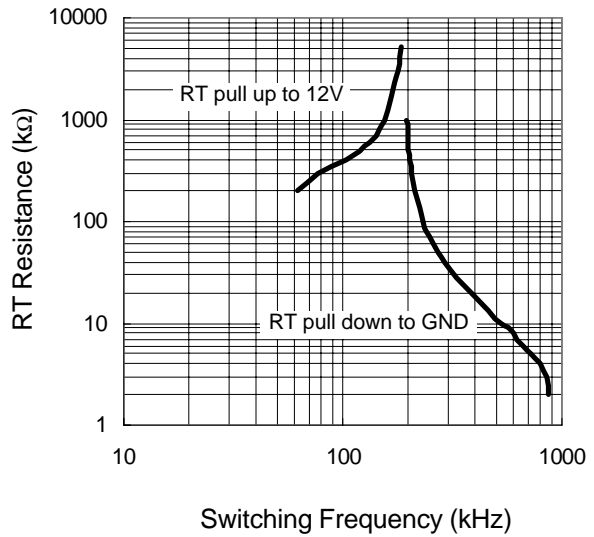

Reference Voltage vs. Junction Temperature

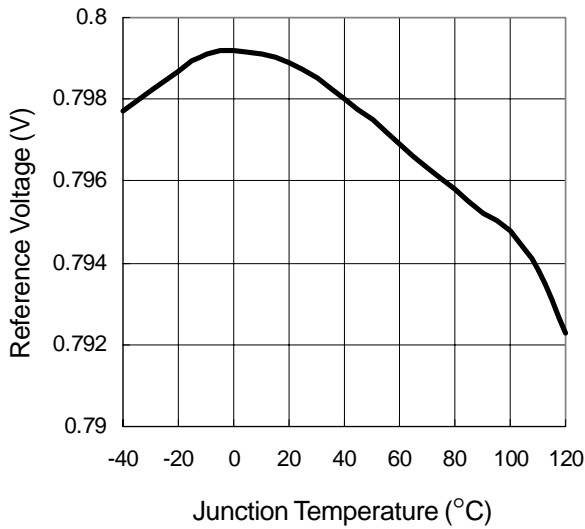

Switching Frequency vs. Junction Temperature

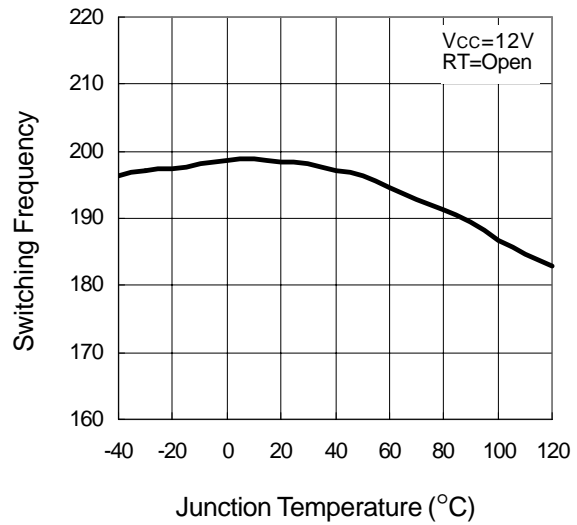

## Application Information

### Component Selection Guidelines

#### Output Capacitor Selection

The selection of  $C_{OUT}$  is determined by the required effective series resistance (ESR) and voltage rating rather than the actual capacitance requirement. Therefore select high performance low ESR capacitors that are intended for switching regulator applications. In some applications, multiple capacitors have to be paralleled to achieve the desired ESR value. If tantalum capacitors are used, make sure they are surge tested by the manufactures. If in doubt, consult the capacitors manufacturer.

#### Input Capacitor Selection

The input capacitor is chosen based on the voltage rating and the RMS current rating. For reliable operation, select the capacitor voltage rating to be at least 1.3 times higher than the maximum input voltage. The maximum RMS current rating requirement is approximately  $I_{OUT}/2$ , where  $I_{OUT}$  is the load current. During power up, the input capacitors have to handle large amount of surge current. If tantalum capacitors are used, make sure they are surge tested by the manufactures. If in doubt, consult the capacitors manufacturer.

For high frequency decoupling, a ceramic capacitor between 0.1uF to 1uF can be connected between  $V_{CC}$  and ground pin.

#### Inductor Selection

The inductance of the inductor is determined by the output voltage requirement. The larger the inductance, the lower the inductor's current ripple. This will translate into lower output ripple voltage. The ripple current and ripple voltage can be approximated by:

$$I_{RIPPLE} = \frac{V_{IN} - V_{OUT}}{F_S \times L} \times \frac{V_{OUT}}{V_{IN}}$$

$$\Delta V_{OUT} = I_{RIPPLE} \times ESR$$

where  $F_S$  is the switching frequency of the regulator.

There is a tradeoff exists between the inductor's ripple current and the regulator load transient response time. A smaller inductor will give the regulator a faster load transient response at the expense of higher ripple current and vice versa. The maximum ripple current occurs at the maximum input voltage. A good starting point is to choose the ripple current to be approximately 30% of the maximum output current.

Once the inductance value has been chosen, select an inductor that is capable of carrying the required peak current without going into saturation. In some type of inductors, especially core that is made of ferrite, the ripple current will increase abruptly when it saturates. This will result in a larger output ripple voltage.

#### MOSFET Selection

The selection of the N-channel power MOSFETs are determined by the  $R_{DS(ON)}$ , reverse transfer capacitance ( $C_{RSS}$ ) and maximum output current requirement. The losses in the MOSFETs have two components: conduction loss and transition loss. For the upper and lower MOSFET, the losses are approximately given by the following :

$$P_{UPPER} = I_{OUT}^2(1+TC)(R_{DS(ON)})D + (0.5)(I_{OUT})(V_{IN})(t_{SW})F_S$$

$$P_{LOWER} = I_{OUT}^2(1+TC)(R_{DS(ON)})(1-D)$$

where  $I_{OUT}$  is the load current

TC is the temperature dependency of  $R_{DS(ON)}$

$F_S$  is the switching frequency

$t_{SW}$  is the switching interval

D is the duty cycle

## Application Information (Cont.)

Note that both MOSFETs have conduction losses while the upper MOSFET include an additional transition loss. The switching interval,  $t_{sw}$ , is a function of the reverse transfer capacitance  $C_{RSS}$ . Figure 3 illustrates the switching waveform internal of the MOSFET.

The  $(1+TC)$  term is to factor in the temperature dependency of the  $R_{DS(ON)}$  and can be extracted from the “ $R_{DS(ON)}$  vs Temperature” curve of the power MOSFET.

### Layout Considerations

In high power switching regulator, a correct layout is important to ensure proper operation of the regulator. In general, interconnecting impedances should be minimized by using short, wide printed circuit traces. Signal and power grounds are to be kept separate and finally combined using ground plane construction or

single point grounding. Figure 4 illustrates the layout, with bold lines indicating high current paths. Components along the bold lines should be placed close together. Below is a checklist for your layout:

- Keep the switching nodes (UGATE, LGATE and PHASE) away from sensitive small signal nodes since these nodes are fast moving signals. Therefore keep traces to these nodes as short as possible.
- The ground return of  $C_{IN}$  must return to the combined  $C_{OUT}$  (-) terminal.
- Capacitor  $C_{BOOT}$  should be connected as close to the BOOT and PHASE pins as possible.

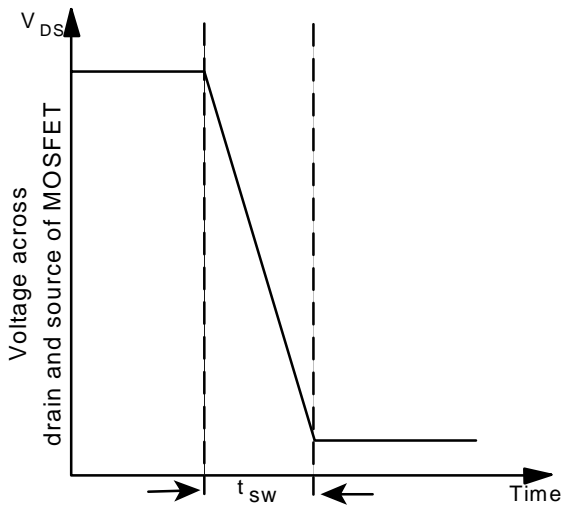

Figure 3. Switching waveform across MOSFET

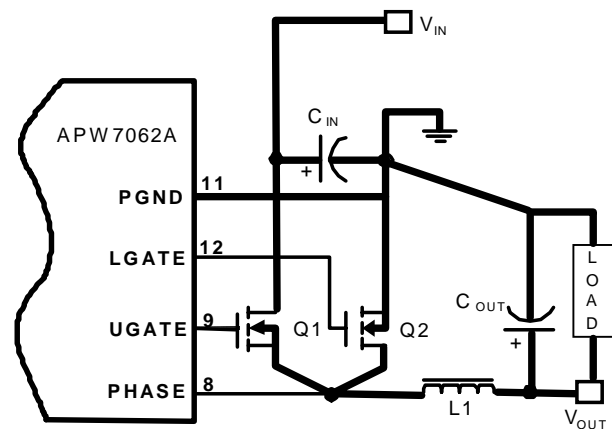
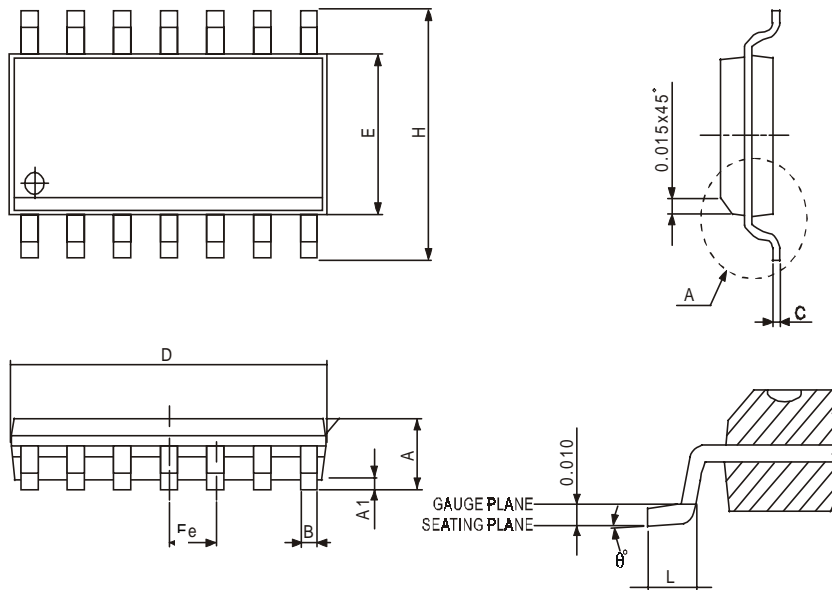

Figure 4. Recommended Layout Diagram

## Package Information

SOP – 14 (150mil)



Dim	Millimeters		Inches	
	Min.	Max.	Min.	Max.
A	1.477	1.732	0.058	0.068
A1	0.102	0.255	0.004	0.010
B	0.331	0.509	0.013	0.020
C	0.191	0.2496	0.0075	0.0098
D	8.558	8.762	0.336	0.344
E	3.82	3.999	0.150	0.157
e	1.274		0.050	
H	5.808	6.215	0.228	0.244
L	0.382	1.274	0.015	0.050
$\theta^\circ$	0°	8°	0°	8°

## Physical Specifications

Terminal Material	Solder-Plated Copper (Solder Material : 90/10 or 63/37 SnPb)
Lead Solderability	Meets EIA Specification RSI86-91, ANSI/J-STD-002 Category 3.
Packaging	2500 devices per reel

### Reflow Condition (IR/Convection or VPR Reflow)

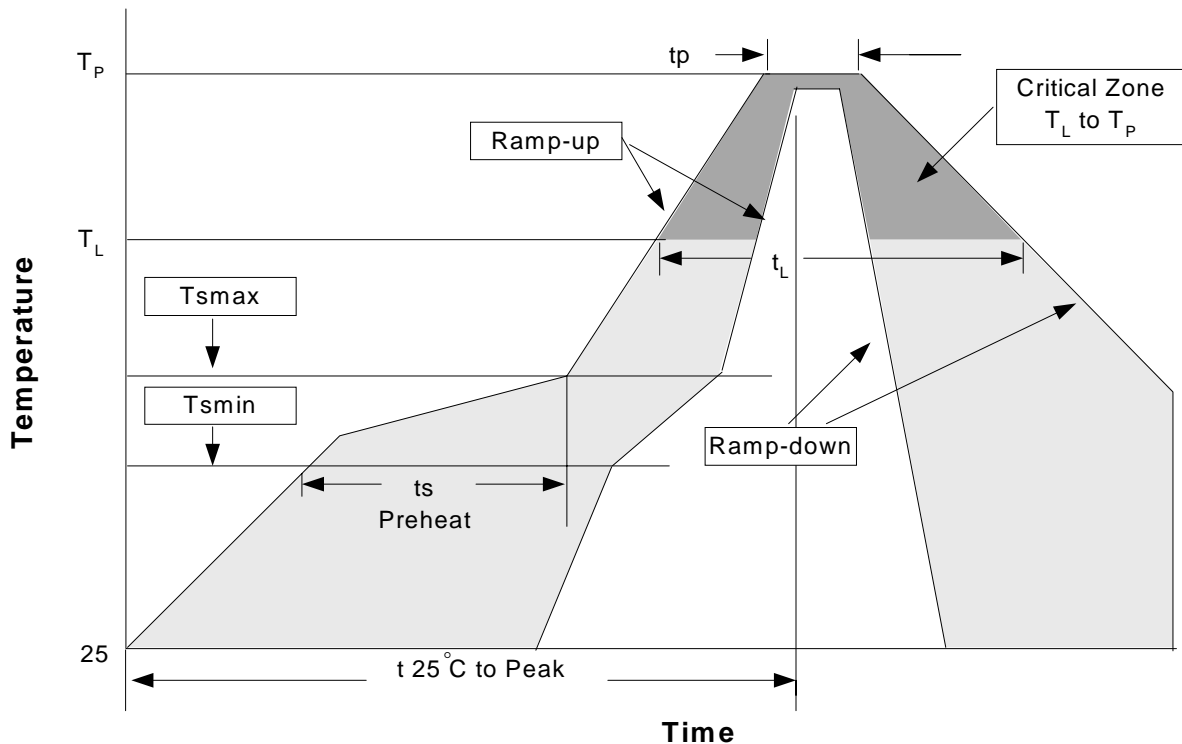

### Classification Reflow Profiles

Profile Feature	Sn-Pb Eutectic Assembly	Pb-Free Assembly
Average ramp-up rate ( $T_L$ to $T_P$ )	3°C/second max.	3°C/second max.
Preheat		
- Temperature Min ( $T_{smin}$ )	100°C	150°C
- Temperature Max ( $T_{smax}$ )	150°C	200°C
- Time (min to max) ( $t_s$ )	60-120 seconds	60-180 seconds
Time maintained above:		
- Temperature ( $T_L$ )	183°C	217°C
- Time ( $t_L$ )	60-150 seconds	60-150 seconds
Peak/Classification Temperature ( $T_p$ )	See table 1	See table 2
Time within 5°C of actual Peak Temperature ( $t_p$ )	10-30 seconds	20-40 seconds
Ramp-down Rate	6°C/second max.	6°C/second max.
Time 25°C to Peak Temperature	6 minutes max.	8 minutes max.

Notes: All temperatures refer to topside of the package .Measured on the body surface.

## Classification Reflow Profiles(Cont.)

Table 1. SnPb Eutectic Process – Package Peak Reflow Temperatures

Package Thickness	Volume mm <sup>3</sup> <350	Volume mm <sup>3</sup> ≥350
<2.5 mm	240 +0/-5°C	225 +0/-5°C
≥2.5 mm	225 +0/-5°C	225 +0/-5°C

Table 2. Pb-free Process – Package Classification Reflow Temperatures

Package Thickness	Volume mm <sup>3</sup> <350	Volume mm <sup>3</sup> 350-2000	Volume mm <sup>3</sup> >2000
<1.6 mm	260 +0°C*	260 +0°C*	260 +0°C*
1.6 mm – 2.5 mm	260 +0°C*	250 +0°C*	245 +0°C*
≥2.5 mm	250 +0°C*	245 +0°C*	245 +0°C*

\*Tolerance: The device manufacturer/supplier **shall** assure process compatibility up to and including the stated classification temperature (this means Peak reflow temperature +0°C. For example 260°C+0°C) at the rated MSL level.

## Reliability Test Program

Test item	Method	Description
SOLDERABILITY	MIL-STD-883D-2003	245°C, 5 SEC
HOLT	MIL-STD-883D-1005.7	1000 Hrs Bias @125°C
PCT	JESD-22-B,A102	168 Hrs, 100%RH, 121°C
TST	MIL-STD-883D-1011.9	-65°C~150°C, 200 Cycles
ESD	MIL-STD-883D-3015.7	VHBM > 2KV, VMM > 200V
Latch-Up	JESD 78	10ms, 1 <sub>tr</sub> > 100mA

## Carrier Tape & Reel Dimension

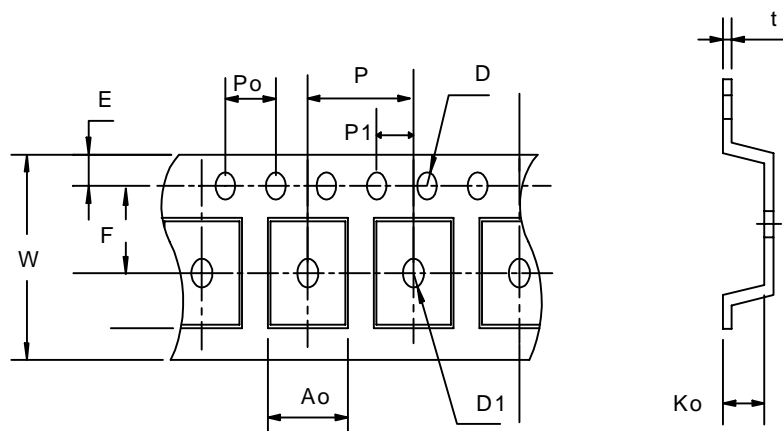

## Carrier Tape & Reel Dimension

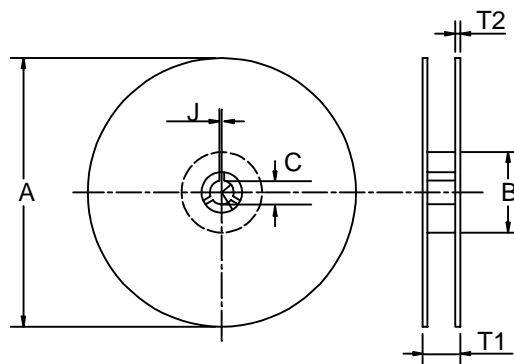

Application	A	B	C	J	T1	T2	W	P	E
SOP-14 (150mil)	330REF	100REF	13.0 + 0.5 - 0.2	2 ± 0.5	16.5REF	2.5 ± 0.25	16.0 ± 0.3	8	1.75
	F	D	D1	Po	P1	Ao	Ko	t	
	7.5	φ0.50 + 0.1	φ1.50 (MIN)	4.0	2.0	6.5	2.10	0.3±0.05	

(mm)

## Cover Tape Dimensions

Application	Carrier Width	Cover Tape Width	Devices Per Reel
SOP- 14	24	21.3	2500

## Customer Service

### Anpec Electronics Corp.

Head Office :

5F, No. 2 Li-Hsin Road, SBIP,  
Hsin-Chu, Taiwan, R.O.C.  
Tel : 886-3-5642000  
Fax : 886-3-5642050

Taipei Branch :

7F, No. 137, Lane 235, Pac Chiao Rd.,  
Hsin Tien City, Taipei Hsien, Taiwan, R. O. C.  
Tel : 886-2-89191368  
Fax : 886-2-89191369