



Advanced Power Electronics Corp.

AP25G45GEM

Pb Free Plating Product

N-CHANNEL INSULATED GATE

BIPOLAR TRANSISTOR

- ▼ High Input Impedance
- ▼ High Pick Current Capability
- ▼ 4.5V Gate Drive
- ▼ Strobe Flash Applications

V_{CE}	450V
I_{CP}	150A

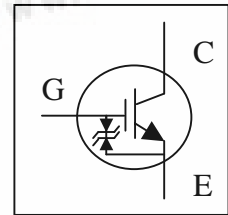
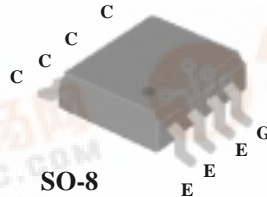

Absolute Maximum Ratings

Symbol	Parameter	Rating	Units
V_{CE}	Collector-Emitter Voltage	450	V
V_{GE}	Gate-Emitter Voltage	± 6	V
I_{GEP}	Pulsed Gate-Emitter Voltage	± 8	V
I_{CP}	Pulsed Collector Current	150	A
$P_D @ T_C=25^\circ C^1$	Maximum Power Dissipation	2.5	W
T_{STG}	Storage Temperature Range	-55 to 150	$^\circ C$
T_J	Operating Junction Temperature Range	-55 to 150	$^\circ C$

Electrical Characteristics @ $T_J=25^\circ C$ (unless otherwise specified)

Symbol	Parameter	Test Conditions	Min.	Typ.	Max.	Units
I_{GES}	Gate-Emitter Leakage Current	$V_{GE}=\pm 6V, V_{CE}=0V$	-	-	10	μA
I_{CES}	Collector-Emitter Leakage Current ($T_J=25^\circ C$)	$V_{CE}=450V, V_{GE}=0V$	-	-	10	μA
$V_{CE(sat)}$	Collector-Emitter Saturation Voltage	$V_{GE}=4.5V, I_{CP}=150A$ (Pulsed)	-	6	8	V
$V_{GE(th)}$	Gate Threshold Voltage	$V_{CE}=V_{GE}, I_C=250\mu A$	0.35	-	1.2	V
Q_g	Total Gate Charge	$I_C=50A$	-	64.5	-	nC
Q_{ge}	Gate-Emitter Charge	$V_{CE}=360V$	-	7	-	nC
Q_{gc}	Gate-Collector Charge	$V_{GE}=4.5V$	-	30	-	nC
$t_{d(on)}$	Turn-on Delay Time	$V_{CC}=225V$	-	11.5	-	ns
t_r	Rise Time	$I_C=50A$	-	24.5	-	ns
$t_{d(off)}$	Turn-off Delay Time	$R_G=25\Omega$	-	150	-	ns
t_f	Fall Time	$V_{GE}=10V$	-	3.3	-	μs
C_{ies}	Input Capacitance	$V_{GE}=0V$	-	2227	-	pF
C_{oes}	Output Capacitance	$V_{CE}=25V$	-	200	-	pF
C_{res}	Reverse Transfer Capacitance	$f=1.0MHz$	-	79	-	pF
R_{thJA}^1	Thermal Resistance Junction-Ambient		-	-	50	$^\circ C/W$

Notes:

1. Surface mounted on 1 in² copper pad of FR4 board ; 125 $^\circ C/W$ when mounted on Min. copper pad.

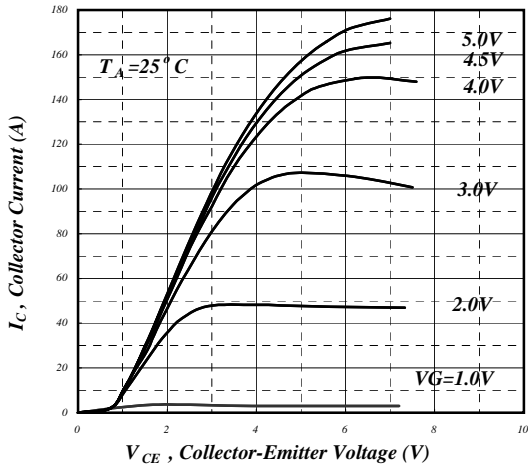

Fig 1. Typical Output Characteristics

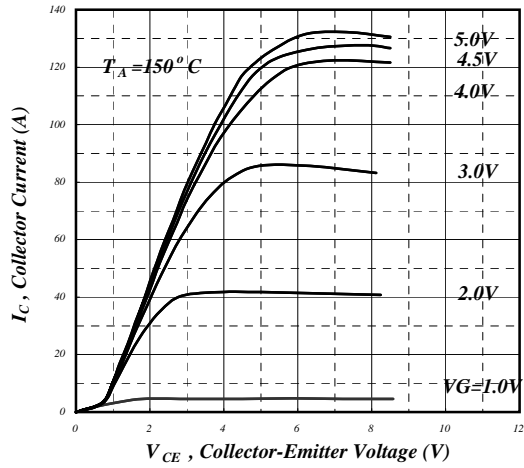

Fig 2. Typical Output Characteristics

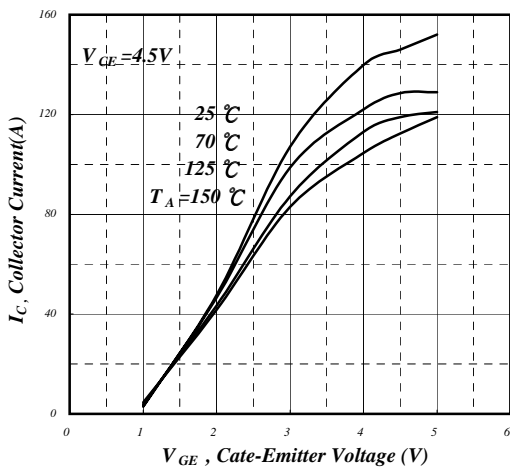

Fig 3. Collector Current v.s. Gate-Emitter Voltage

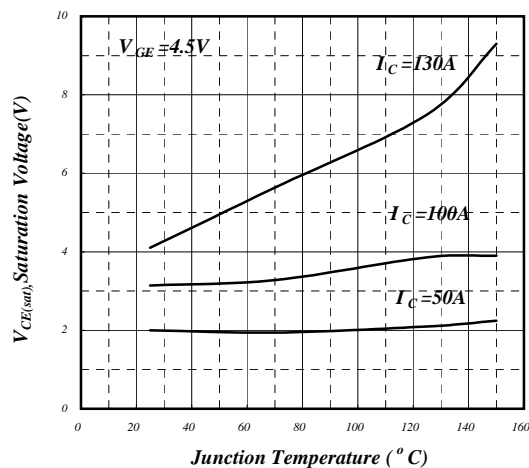

Fig 4. Collector-Emitter Saturation Voltage v.s. Junction Temperature

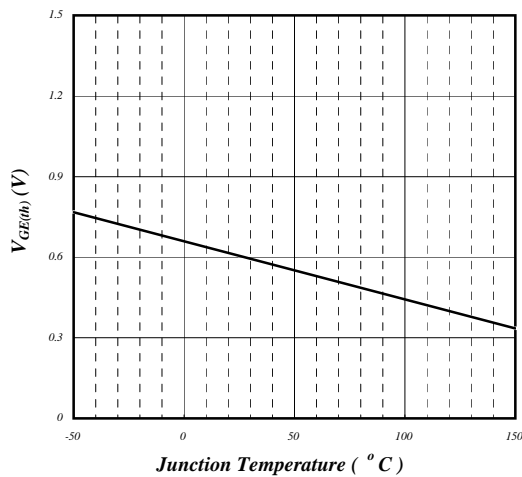

Fig 5. Gate Threshold Voltage v.s. Junction Temperature

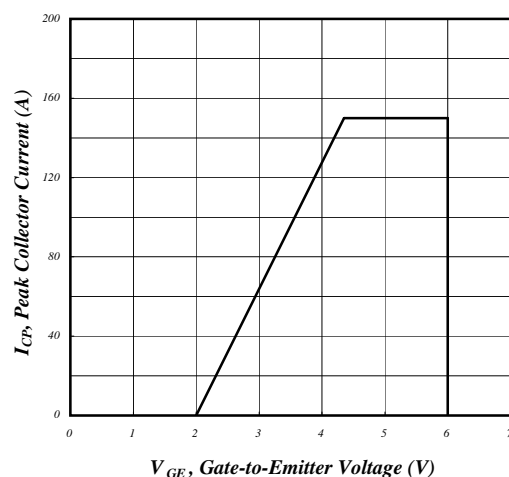

Fig 6. Minimum Gate Drive Area

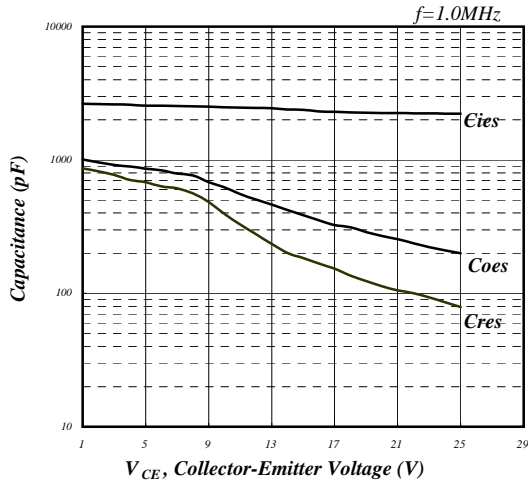

Fig 7. Typical Capacitance Characteristics

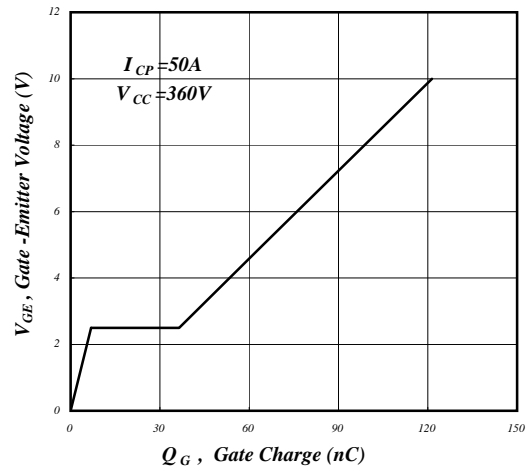

Fig 8. Gate Charge Waveform

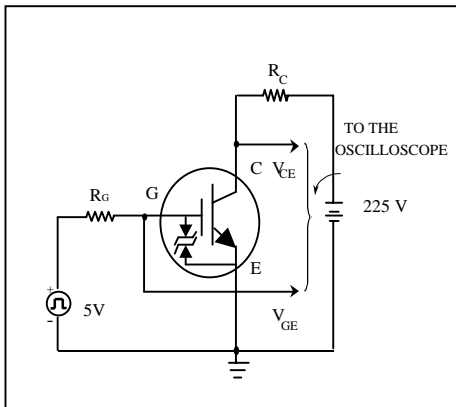

Fig 9. Switching Time Test Circuit

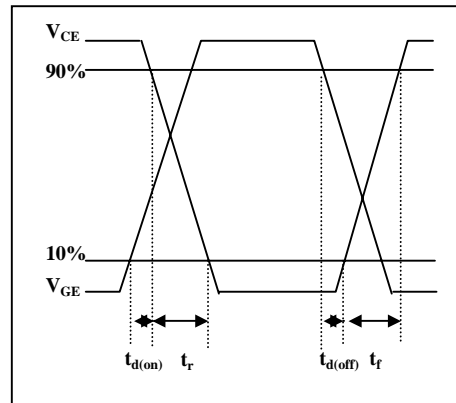

Fig 10. Switching Time Waveform

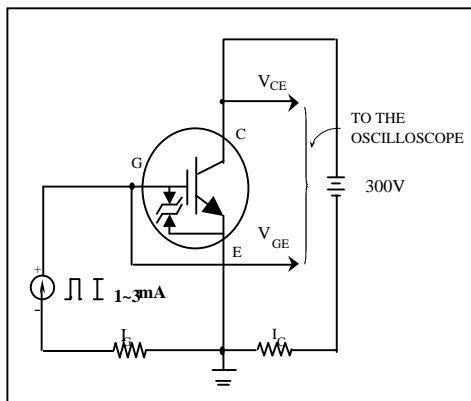

Fig 11. Gate Charge Test Circuit

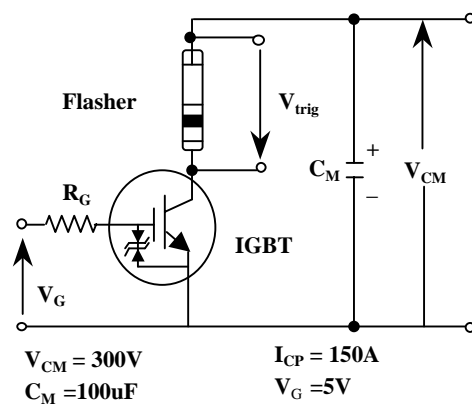

Fig 12. Application Test Circuit