

AP9926O



**Advanced Power
Electronics Corp.**

*N-CHANNEL ENHANCEMENT MODE
POWER MOSFET*

- ▼ Low on-resistance
- ▼ Capable of 2.5V gate drive
- ▼ Low drive current
- ▼ Surface mount package

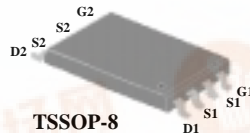

BV_{DSS}	20V
$R_{DS(ON)}$	28mΩ
I_D	4.6A

Description

The Advanced Power MOSFETs from APEC provide the designer with the best combination of fast switching, ruggedized device design, ultra low on-resistance and cost-effectiveness.

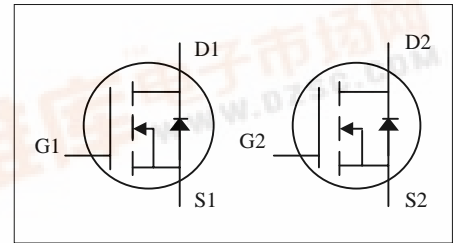

Absolute Maximum Ratings

Symbol	Parameter	Rating	Units
V_{DS}	Drain-Source Voltage	20	V
V_{GS}	Gate-Source Voltage	± 8	V
$I_D @ T_A=25^\circ C$	Continuous Drain Current ³	4.6	A
$I_D @ T_A=70^\circ C$	Continuous Drain Current ³	3.7	A
I_{DM}	Pulsed Drain Current ¹	20	A
$P_D @ T_A=25^\circ C$	Total Power Dissipation	1	W
	Linear Derating Factor	0.008	W/°C
T_{STG}	Storage Temperature Range	-55 to 150	°C
T_J	Operating Junction Temperature Range	-55 to 150	°C

Thermal Data

Symbol	Parameter	Value	Unit
Rthj-a	Thermal Resistance Junction-ambient ³	Max. 125	°C/W





AP99260

Electrical Characteristics @T_j=25°C(unless otherwise specified)

Symbol	Parameter	Test Conditions	Min.	Typ.	Max.	Units
BV _{DSS}	Drain-Source Breakdown Voltage	V _{GS} =0V, I _D =250uA	20	-	-	V
ΔBV _{DSS} /ΔT _j	Breakdown Voltage Temperature Coefficient	Reference to 25°C, I _D =1mA	-	0.1	-	V/°C
R _{DS(ON)}	Static Drain-Source On-Resistance ²	V _{GS} =4.5V, I _D =4A	-	23	28	mΩ
		V _{GS} =2.5V, I _D =2A	-	-	40	mΩ
V _{GS(th)}	Gate Threshold Voltage	V _{DS} =V _{GS} , I _D =250uA	0.5	-	-	V
g _{fs}	Forward Transconductance	V _{DS} =10V, I _D =4.6A	-	9.7	-	S
I _{DSS}	Drain-Source Leakage Current (T _j =25°C)	V _{DS} =20V, V _{GS} =0V	-	-	1	uA
	Drain-Source Leakage Current (T _j =70°C)	V _{DS} =20V, V _{GS} =0V	-	-	25	uA
I _{GSS}	Gate-Source Leakage	V _{GS} = ± 8V	-	-	±100	nA
Q _g	Total Gate Charge ²	I _D =4.6A	-	12.5	-	nC
Q _{gs}	Gate-Source Charge	V _{DS} =20V	-	1	-	nC
Q _{gd}	Gate-Drain ("Miller") Charge	V _{GS} =5V	-	6.5	-	nC
t _{d(on)}	Turn-on Delay Time ²	V _{DS} =10V	-	7	-	ns
t _r	Rise Time	I _D =1A	-	14.5	-	ns
t _{d(off)}	Turn-off Delay Time	R _G =3.3Ω, V _{GS} =5V	-	19	-	ns
t _f	Fall Time	R _D =10Ω	-	12	-	ns
C _{iss}	Input Capacitance	V _{GS} =0V	-	355	-	pF
C _{oss}	Output Capacitance	V _{DS} =20V	-	190	-	pF
C _{riss}	Reverse Transfer Capacitance	f=1.0MHz	-	85	-	pF

Source-Drain Diode

Symbol	Parameter	Test Conditions	Min.	Typ.	Max.	Units
I _S	Continuous Source Current (Body Diode)	V _D =V _G =0V, V _S =1.2V	-	-	0.83	A
V _{SD}	Forward On Voltage ²	T _j =25°C, I _S =1.25A, V _{GS} =0V	-	-	1.2	V

Notes:

- 1.Pulse width limited by Max. junction temperature.
- 2.Pulse width ≤300us , duty cycle ≤2%.
- 3.Surface mounted on 1 in² copper pad of FR4 board ; 208°C/W when mounted on Min. copper pad.

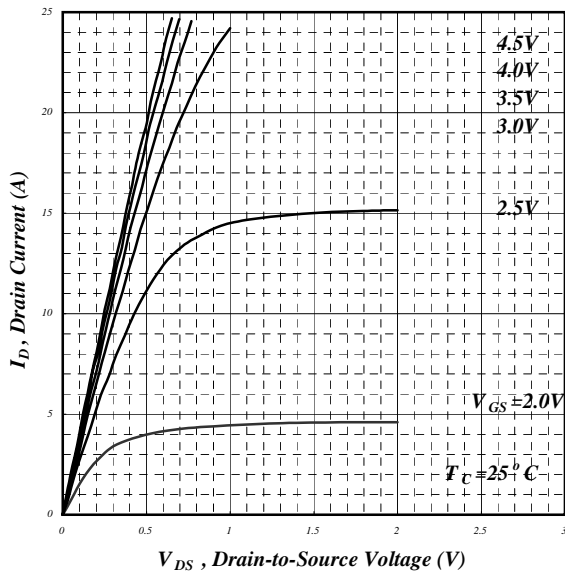

Fig 1. Typical Output Characteristics

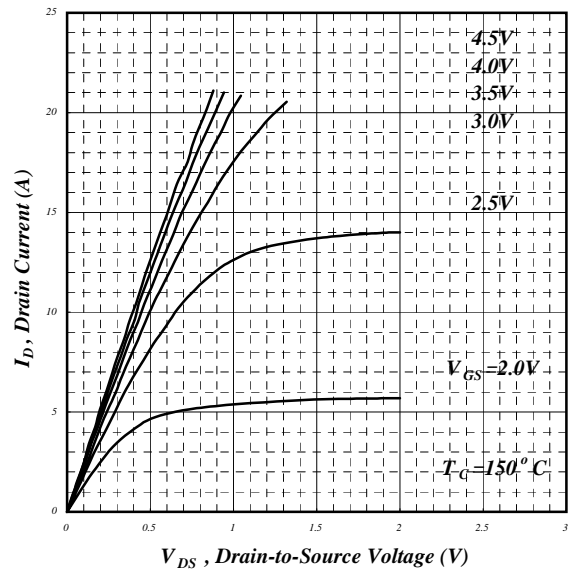

Fig 2. Typical Output Characteristics

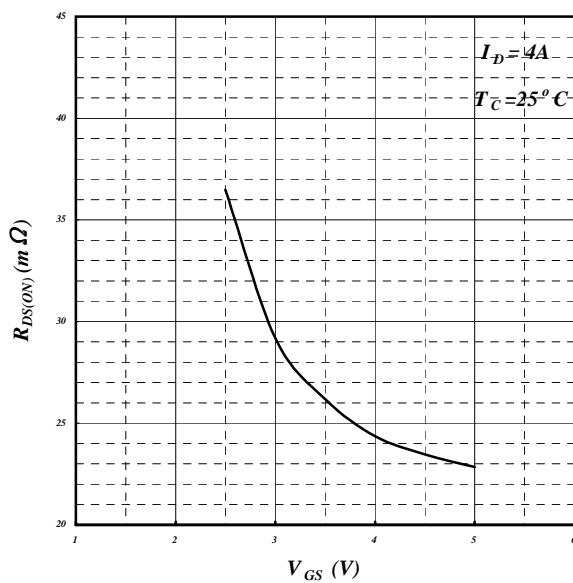

Fig 3. On-Resistance v.s. Gate Voltage

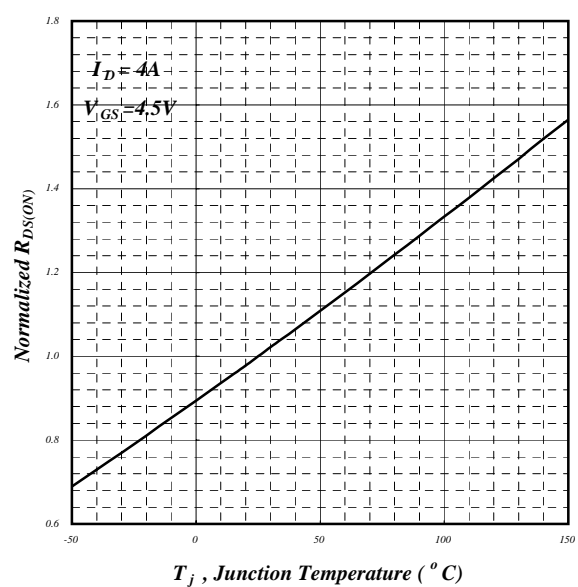

Fig 4. Normalized On-Resistance v.s. Junction Temperature

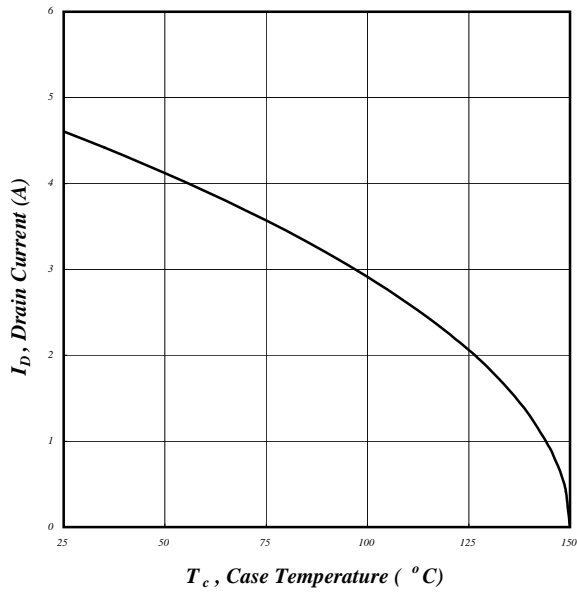

Fig 5. Maximum Drain Current v.s. Case Temperature

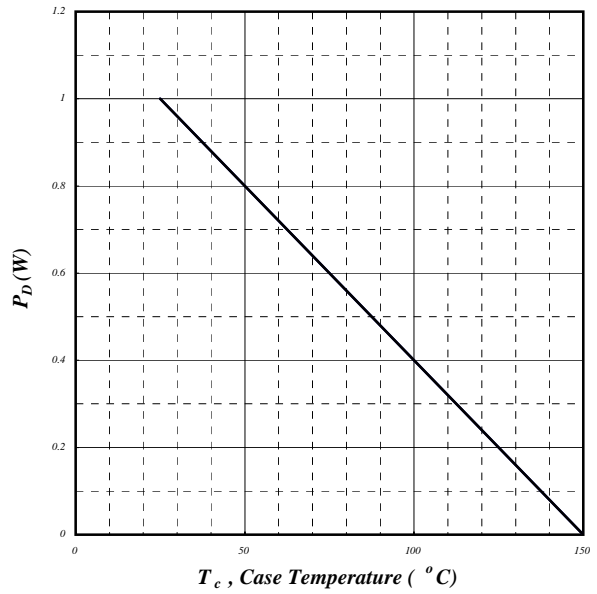

Fig 6. Typical Power Dissipation

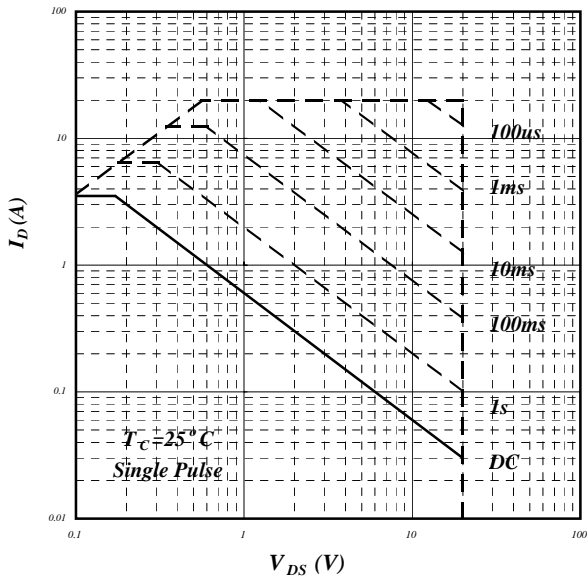

Fig 7. Maximum Safe Operating Area

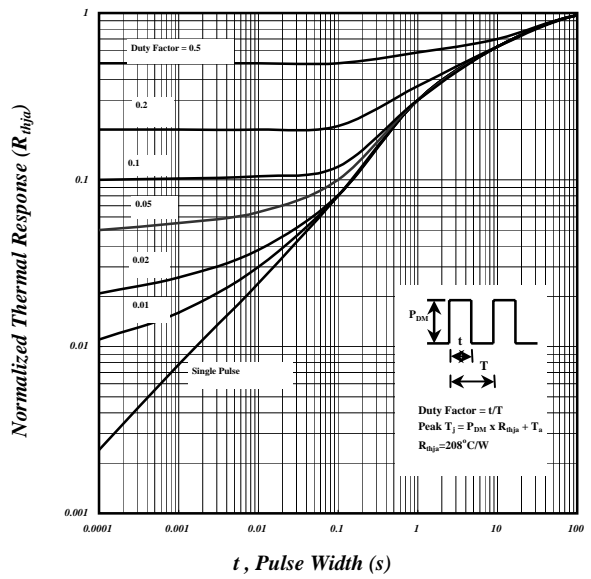

Fig 8. Effective Transient Thermal Impedance

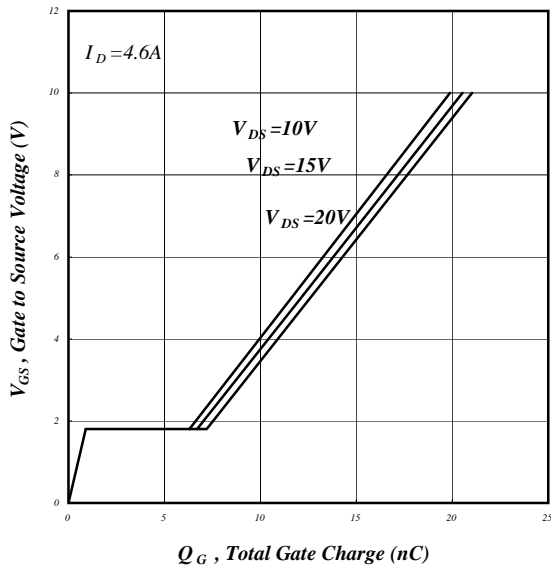

Fig 9. Gate Charge Characteristics

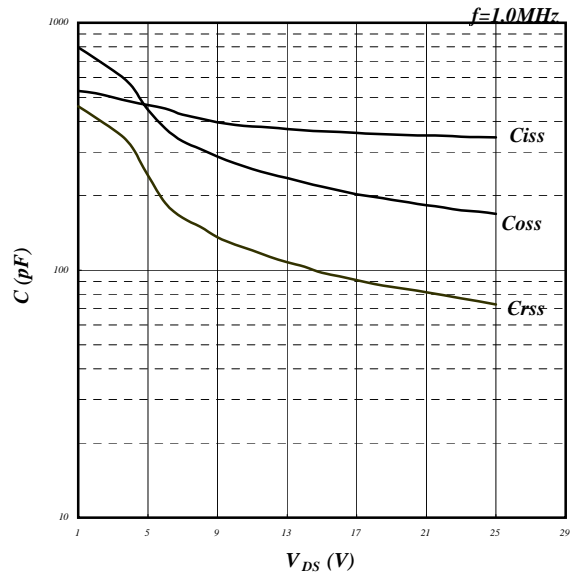

Fig 10. Typical Capacitance Characteristics

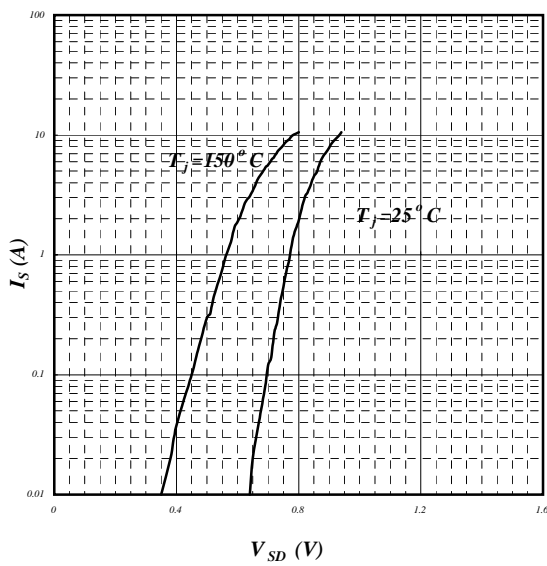

Fig 11. Forward Characteristic of Reverse Diode

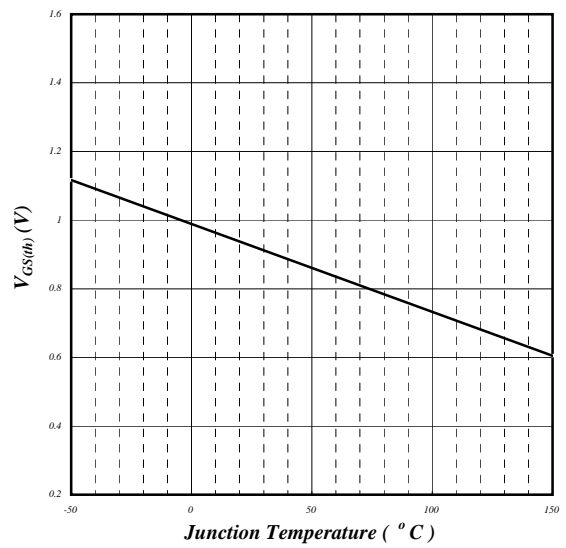

Fig 12. Gate Threshold Voltage v.s. Junction Temperature

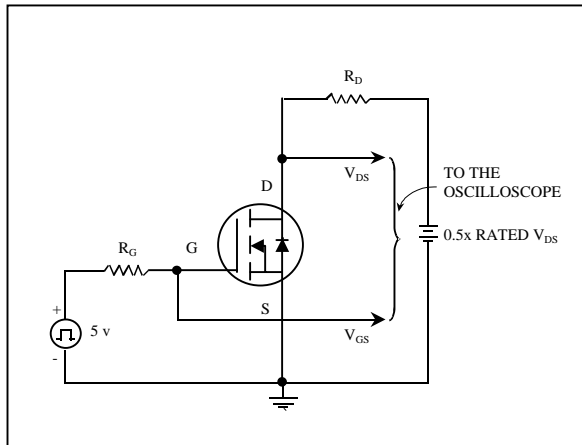

Fig 13. Switching Time Circuit

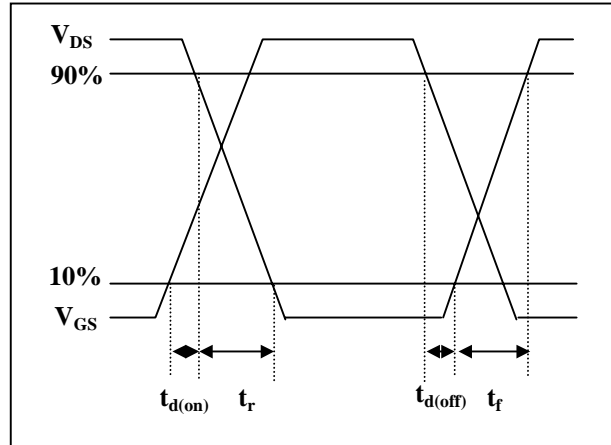

Fig 14. Switching Time Waveform

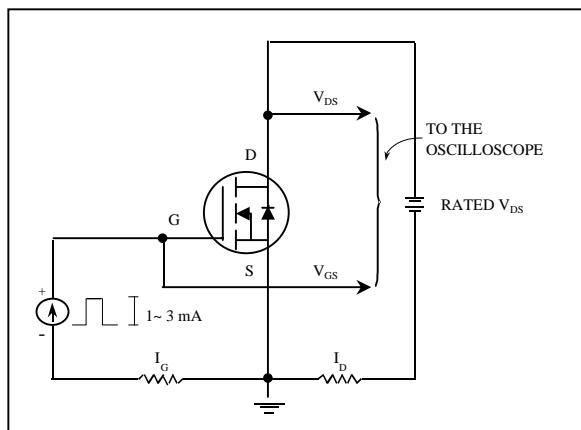

Fig 15. Gate Charge Circuit

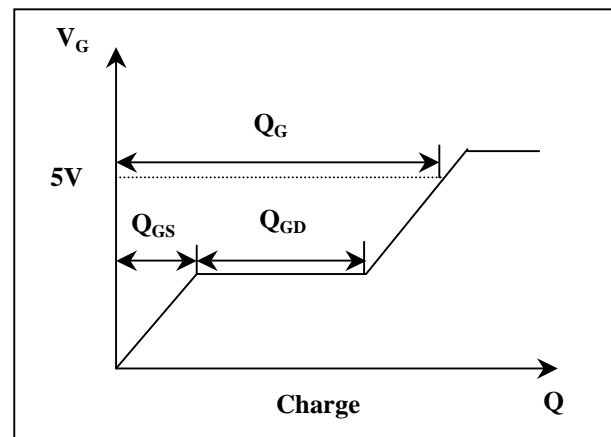

Fig 16. Gate Charge Waveform