



# AZ10ELT20 AZ100ELT20

## CMOS/TTL to Differential PECL Translator

### FEATURES

- 0.5ns Typical Propagation Delay
- Differential PECL Outputs
- Flow Through Pinouts
- Operating Range of +3.0V to +5.5V
- Direct Replacement for ON Semi MC100ELT20 & Micrel SY89329V
- Available in 2x2 and 3x3 mm MLP Packages
- IBIS Model Files Available on Arizona Microtek Website

### PACKAGE AVAILABILITY

PACKAGE	PART NUMBER	MARKING	NOTES
MLP 8 (2x2x0.75)	AZ100ELT20N	TC <Date Code>	1,2
MLP 8 (2x2x0.75) Green / RoHS Compliant / Lead (Pb) Free	AZ100ELT20NG	TCG <Date Code>	1,2
MLP 16 (3x3)	AZ10/100ELT20L	AZM T20 <Date Code>	1,2
MLP 16 (3x3) Green / RoHS Compliant / Lead (Pb) Free	AZ10/100ELT20LG	AZMG T20 <Date Code>	1,2
SOIC 8	AZ10ELT20D	AZM10 ELT20	1,2,3
SOIC 8	AZ100ELT20D	AZM100 ELT20	1,2,3
SOIC 8 RoHS Compliant / Lead (Pb) Free	AZ100ELT20D+	AZM100+ ELT20	1,2,3
SOIC 8 Green / RoHS Compliant / Lead (Pb) Free	AZ100ELT20DG	AZM100G ELT20	1,2,3
TSSOP 8	AZ100ELT20T	AZH LT20	1,2,3
TSSOP 8 Green / RoHS Compliant / Lead (Pb) Free	AZ100ELT20TG	AZHG LT20	1,2,3
DIE	AZ10/100ELT20XP	N/A	4

### DESCRIPTION

The AZ10/100ELT20 is a CMOS/TTL to differential PECL translator. It operates with a single power supply of +3.0 to +5.5 volts, making it ideal for both LVC MOS/LVTTL and CMOS/TTL applications. The extremely small MLP 8 2x2 mm package makes it ideal for those applications where space, performance and low power are at a premium.

When the D input is left floating, the Q output is forced HIGH, and the Q output is forced LOW.

The ELT20 is available in both PECL standards: the AZ10ELT20 is compatible with PECL 10K logic levels while the AZ100ELT20 is compatible with PECL 100K logic levels.

NOTE: Specifications in the PECL tables are valid when thermal equilibrium is established.

### BLOCK DIAGRAM

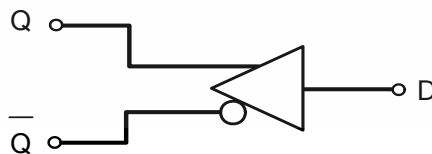

- 1 Add R1 at end of part number for 7 inch (1K parts), R2 for 13 inch (2.5K parts) Tape & Reel.
- 2 Date code format: "Y" or "YY" for year followed by "WW" for week.
- 3 Date code "YWW" or "YYWW" on underside of part.
- 4 Waffle Pack.



# AZ10ELT20

## AZ100ELT20

**Absolute Maximum Ratings** are those values beyond which device life may be impaired.

Symbol	Characteristic	Value	Unit	
V <sub>CC</sub>	DC Supply Voltage (Referenced to GND)	0 to +8.0	V	
V <sub>IN</sub>	Input Voltage	0 to +6.0	V	
I <sub>OUT</sub>	Current Applied to Output in Low Output State	— Continuous — Surge	50 100	mA
T <sub>A</sub>	Operating Temperature Range (In Free-Air)	-40 to +85	°C	
T <sub>STG</sub>	Storage Temperature Range	-65 to +150	°C	

### TTL/CMOS INPUT DC CHARACTERISTICS (GND = 0.0V, V<sub>CC</sub> = +3.0V to +5.5V)

Symbol	Characteristic	Min	Typ	Max	Unit	Condition
I <sub>IH</sub>	Input HIGH Current			15	μA	V <sub>IN</sub> = 2.7V
I <sub>IHH</sub>	Input HIGH Current			20	μA	V <sub>IN</sub> = V <sub>CC</sub>
I <sub>IL</sub>	Input LOW Current			-0.1	mA	V <sub>IN</sub> = 0.5V
V <sub>IK</sub>	Input Clamp Diode Voltage			-1.2	V	I <sub>IN</sub> = -18mA
V <sub>IH</sub>	Input HIGH Voltage	2.0			V	
V <sub>IL</sub>	Input LOW Voltage			0.8	V	

### 10K LVPECL DC Characteristics (GND = 0.0V, V<sub>CC</sub> = +3.3V)

Symbol	Characteristic	-40°C			0°C			25°C			85°C			Unit
		Min	Typ	Max	Min	Typ	Max	Min	Typ	Max	Min	Typ	Max	
V <sub>OH</sub>	Output HIGH Voltage <sup>1,2</sup>	2220		2410	2280		2460	2320		2490	2390		2580	mV
V <sub>OL</sub>	Output LOW Voltage <sup>1,2</sup>	1350		1650	1350		1670	1350		1670	1350		1705	mV
I <sub>CC</sub>	Power Supply Current <sup>3</sup>			16			16			16			16	mA

- Output parameters vary 1:1 with V<sub>CC</sub>.
- Each output is terminated through a 50Ω resistor to V<sub>CC</sub> - 2V.
- I<sub>CC</sub> measurements must be done with outputs open.

### 10K PECL DC Characteristics (GND = 0.0V, V<sub>CC</sub> = +5.0V)

Symbol	Characteristic	-40°C			0°C			25°C			85°C			Unit
		Min	Typ	Max	Min	Typ	Max	Min	Typ	Max	Min	Typ	Max	
V <sub>OH</sub>	Output HIGH Voltage <sup>1,2</sup>	3920		4110	3980		4160	4020		4190	4090		4280	mV
V <sub>OL</sub>	Output LOW Voltage <sup>1,2</sup>	3050		3350	3050		3370	3050		3370	3050		3405	mV
I <sub>CC</sub>	Power Supply Current <sup>3</sup>			16			16			16			16	mA

- Output parameters vary 1:1 with V<sub>CC</sub>.
- Each output is terminated through a 50Ω resistor to V<sub>CC</sub> - 2V.
- I<sub>CC</sub> measurements must be done with outputs open.

### 100K LVPECL DC Characteristics (GND = 0.0V, V<sub>CC</sub> = +3.3V)

Symbol	Characteristic	-40°C			0°C			25°C			85°C			Unit
		Min	Typ	Max	Min	Typ	Max	Min	Typ	Max	Min	Typ	Max	
V <sub>OH</sub>	Output HIGH Voltage <sup>1,2</sup>	2220		2420	2275		2420	2275		2420	2275		2420	mV
V <sub>OL</sub>	Output LOW Voltage <sup>1,2</sup>	1400		1750	1400		1680	1400		1680	1400		1680	mV
I <sub>CC</sub>	Power Supply Current <sup>3</sup>			16			16			16			16	mA

- Output parameters vary 1:1 with V<sub>CC</sub>.
- Each output is terminated through a 50Ω resistor to V<sub>CC</sub> - 2V.
- I<sub>CC</sub> measurements must be done with outputs open.

### 100K PECL DC Characteristics (GND = 0.0V, V<sub>CC</sub> = +5.0V)

Symbol	Characteristic	-40°C			0°C			25°C			85°C			Unit
		Min	Typ	Max	Min	Typ	Max	Min	Typ	Max	Min	Typ	Max	
V <sub>OH</sub>	Output HIGH Voltage <sup>1,2</sup>	3920		4120	3975		4120	3975		4120	3975		4120	mV
V <sub>OL</sub>	Output LOW Voltage <sup>1,2</sup>	3100		3450	3100		3380	3100		3380	3100		3380	mV
I <sub>CC</sub>	Power Supply Current <sup>3</sup>			16			16			16			16	mA

- Output parameters vary 1:1 with V<sub>CC</sub>.
- Each output is terminated through a 50Ω resistor to V<sub>CC</sub> - 2V.
- I<sub>CC</sub> measurements must be done with outputs open.

# AZ10ELT20 AZ100ELT20

## AC CHARACTERISTICS (GND = 0.0V, V<sub>CC</sub> = +3.0V to +5.5V)

Symbol	Characteristic	-40°C		0°C		25°C			85°C		Unit	Condition
		Min	Max	Min	Max	Min	Typ	Max	Min	Max		
t <sub>PLH</sub> /t <sub>PHL</sub>	Propagation Delay <sup>1</sup>	100	600	100	600	100		600	100	600	ps	
t <sub>r</sub> /t <sub>f</sub>	Output Rise/Fall Time	200	500	200	500	200		500	200	500	ps	20-80%
f <sub>MAX</sub>	Maximum Frequency <sup>2</sup>	800		800		800			800		MHz	

1. Propagation delay is measured from +1.5V on the input to 50% of the PECL output swing. Input rise/fall times are < 1ns/V.
2. Output at -3 dB.

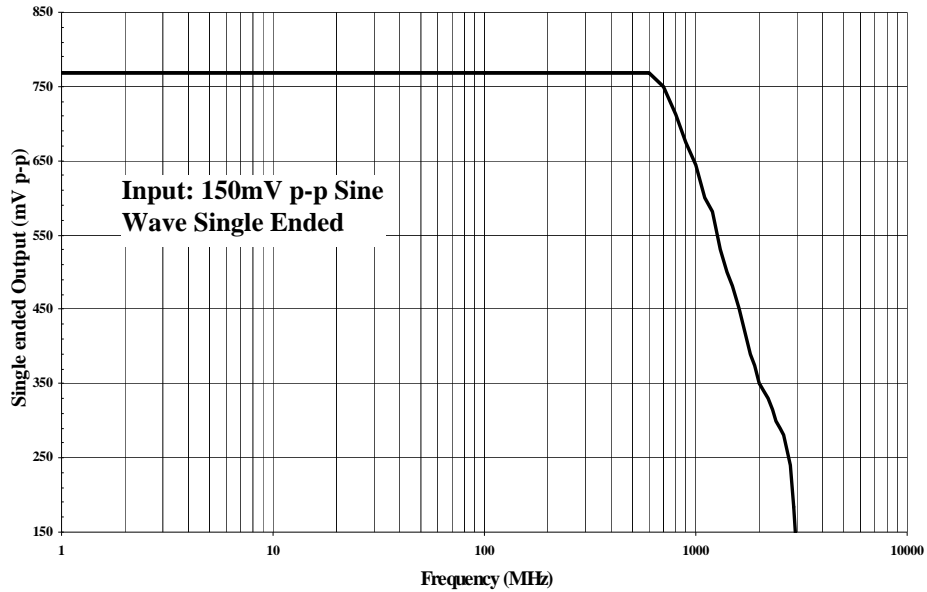

### Large Signal Bandwidth

**AZ10ELT20**  
**AZ100ELT20**

**PIN DESCRIPTION**

PIN	FUNCTION
Q, Q	Differential PECL Outputs
D	TTL/CMOS Input
GND	Ground
V <sub>CC</sub>	Positive Supply
NC	No Connect, Leave Open Except as Noted
10K	10K/100K Mode Select

**AZ100ELT20N**

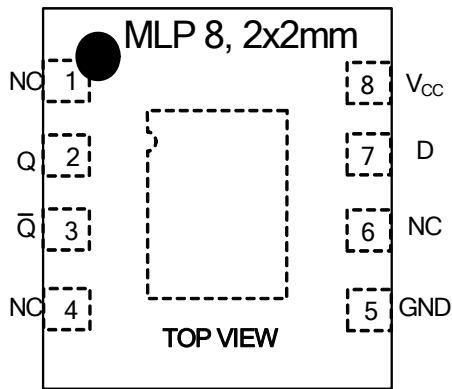

**MLP 16 (L) Package and DIE:**  
**10K/100K Selection**

Connect pin/pad 10K to GND to select 10K operation. Float (NC) pin/pad 10K to select 100K operation. GND connection must be less than 1Ω.

Pin 8 of the MLP 16 package may be connected to pin 7 (GND) with no effect on the circuit.

Leave Center Bottom Pad open or connect to GND.

**AZ10ELT20D**  
**AZ100ELT20D**  
**AZ100ELT20T**

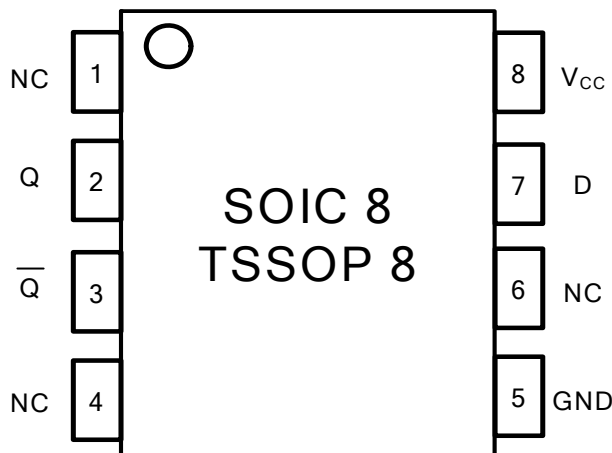

**AZ10/100ELT20L**

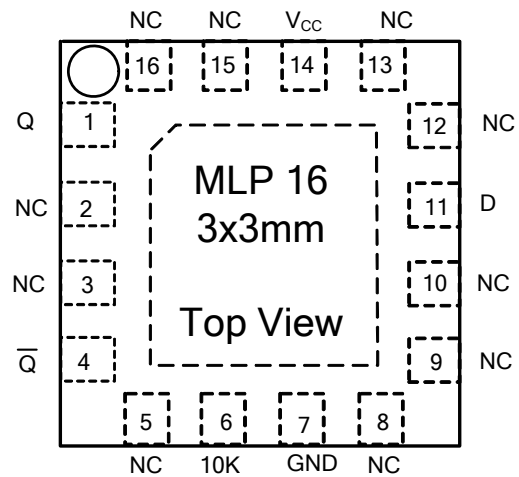

Leave Center Bottom Pad open or connect to GND.

**AZ10ELT20  
AZ100ELT20**

**DIE PAD COORDINATES**

**AZ10/100ELT20 DIE:**

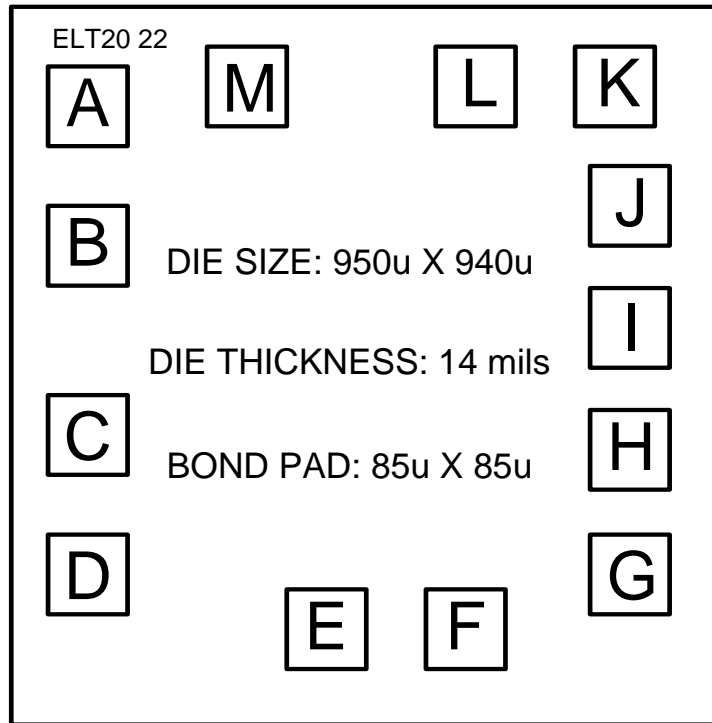

**Note: Other die thicknesses available. Contact factory for further information.  
The die backside may be left open or connected to GND.**

**PAD CENTER COORDINATES**

NAME	PAD DESIGNATION	X(Microns)	Y(Microns)
A	NC	-342.5	312.5
B	NC	-342.5	144.5
C	D	-342.5	-87.0
D	NC	-342.5	-255.0
E	V <sub>CC</sub>	-33.5	-312.5
F	V <sub>CC</sub>	126.5	-312.5
G	Q	312.5	-248.5
H	Q	312.5	-98.5
I	NC	312.5	51.5
J	NC	312.5	201.5
K	NC	302.5	342.5
L	10K	142.5	342.5
M	GND	-140.5	342.5

NC = No connect, leave open.

AZ10ELT20  
AZ100ELT20

**PACKAGE DIAGRAM**  
**MLP 8 2x2mm**

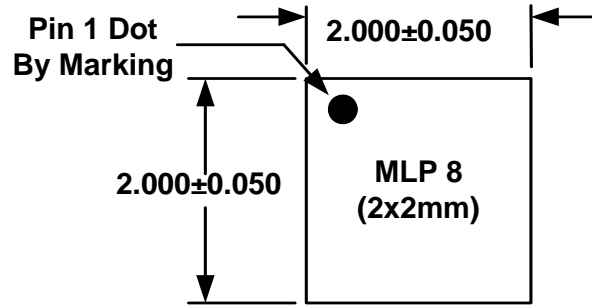

TOP VIEW

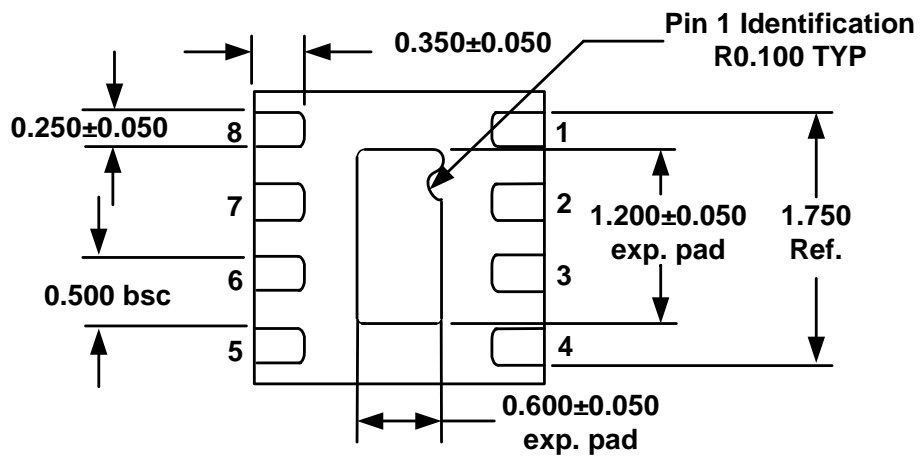

BOTTOM VIEW

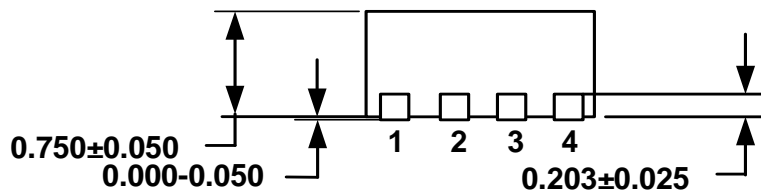

SIDE VIEW

**Note: All dimensions are in mm**

**AZ10ELT20**  
**AZ100ELT20**

**PACKAGE DIAGRAM**  
**SOIC 8**

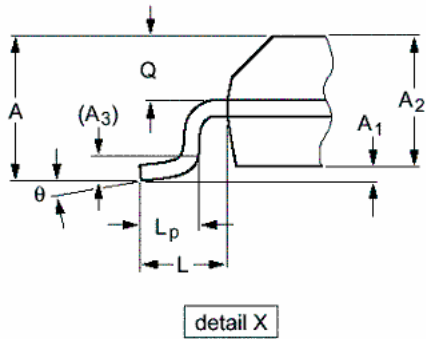
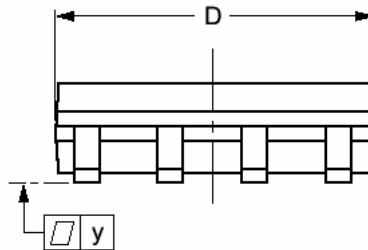
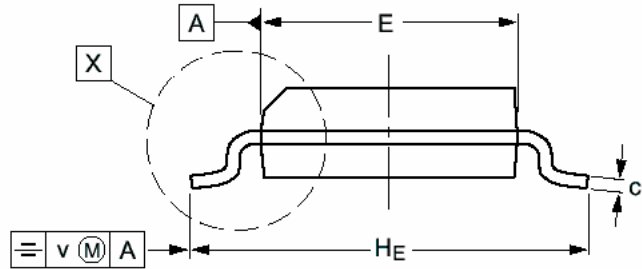
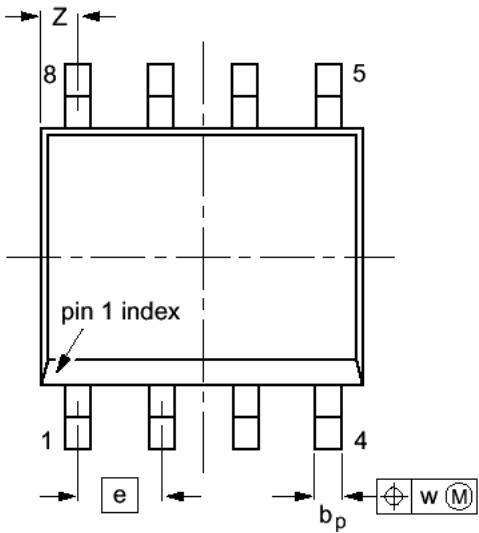

DIM	MILLIMETERS		INCHES	
	MIN	MAX	MIN	MAX
<b>A</b>	1.35	1.75	.053	0.069
<b>A<sub>1</sub></b>	0.10	0.25	0.004	0.010
<b>A<sub>2</sub></b>	1.28	1.57	0.050	0.062
<b>A<sub>3</sub></b>	0.25		0.01	
<b>b<sub>p</sub></b>	0.36	0.49	0.014	0.019
<b>c</b>	0.19	0.25	0.0075	0.0100
<b>D</b>	4.80	5.00	0.19	0.20
<b>E</b>	3.80	4.00	0.15	0.16
<b>e</b>	1.27		0.050	
<b>H<sub>E</sub></b>	5.80	6.20	0.228	0.244
<b>L</b>	1.05		0.041	
<b>L<sub>p</sub></b>	0.40	1.27	0.016	0.050
<b>Q</b>	0.60	0.70	0.024	0.028
<b>v</b>	0.25		0.01	
<b>w</b>	0.25		0.01	
<b>y</b>	0.10		0.004	
<b>Z</b>	0.30	0.70	0.012	0.028
<b>θ</b>	0°	8°	0°	8°

- NOTES:
1. DIMENSIONS D AND E DO NOT INCLUDE MOLD PROTRUSION.
  2. MAXIMUM MOLD PROTRUSION FOR D IS 0.15mm.
  3. MAXIMUM MOLD PROTRUSION FOR E IS 0.25mm.

**AZ10ELT20**  
**AZ100ELT20**

**PACKAGE DIAGRAM**  
**TSSOP 8**

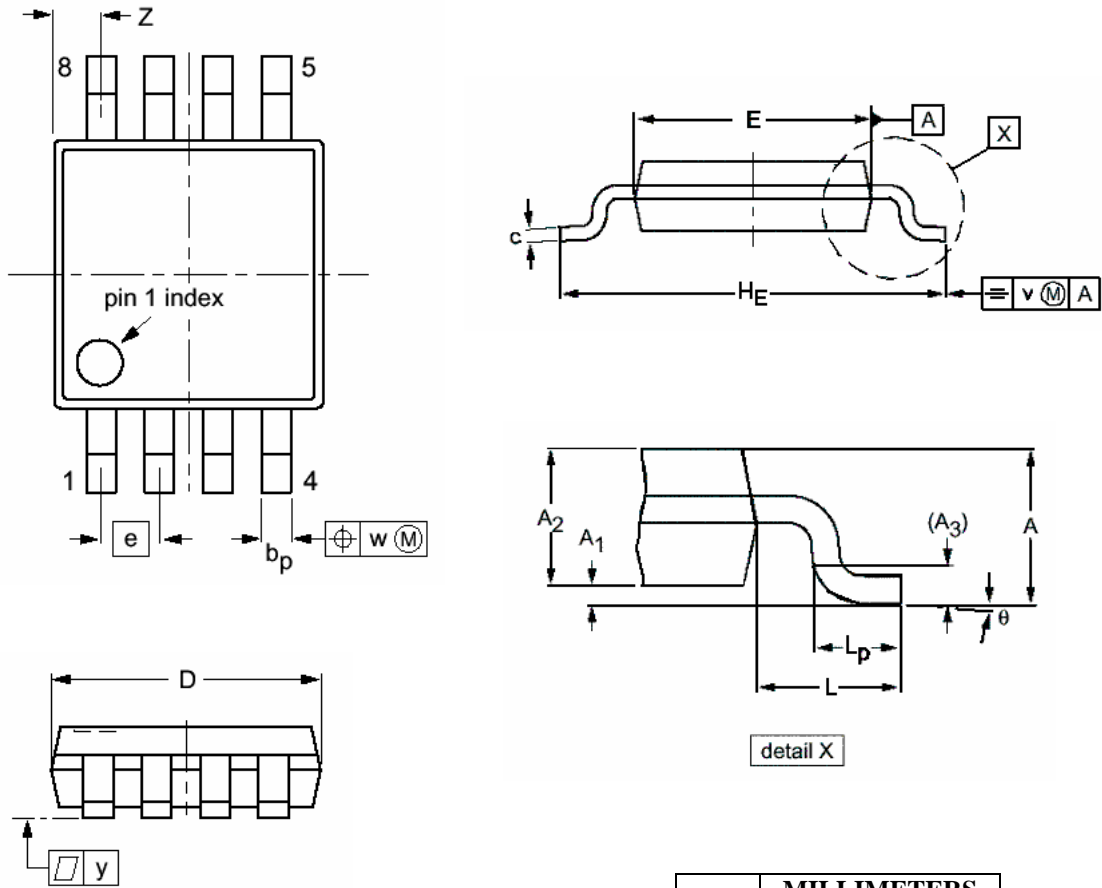

- NOTES:
1. DIMENSIONS D AND E DO NOT INCLUDE MOLD PROTRUSION.
  2. MAXIMUM MOLD PROTRUSION FOR D IS 0.15mm.
  3. MAXIMUM MOLD PROTRUSION FOR E IS 0.25mm.

DIM	MILLIMETERS	
	MIN	MAX
A		1.10
A <sub>1</sub>	0.05	0.15
A <sub>2</sub>	0.75	0.95
A <sub>3</sub>	0.25	
b <sub>p</sub>	0.22	0.40
c	0.13	0.23
D	2.90	3.10
E	2.90	3.10
e	0.65	
H <sub>E</sub>	4.75	5.05
L	0.95	
L <sub>p</sub>	0.40	0.70
v	0.10	
w	0.08	
y	0.10	
Z	0.38	0.64
θ	0°	6°



**AZ10ELT20**  
**AZ100ELT20**

**PACKAGE DIAGRAM**  
**MLP 16 3x3mm**

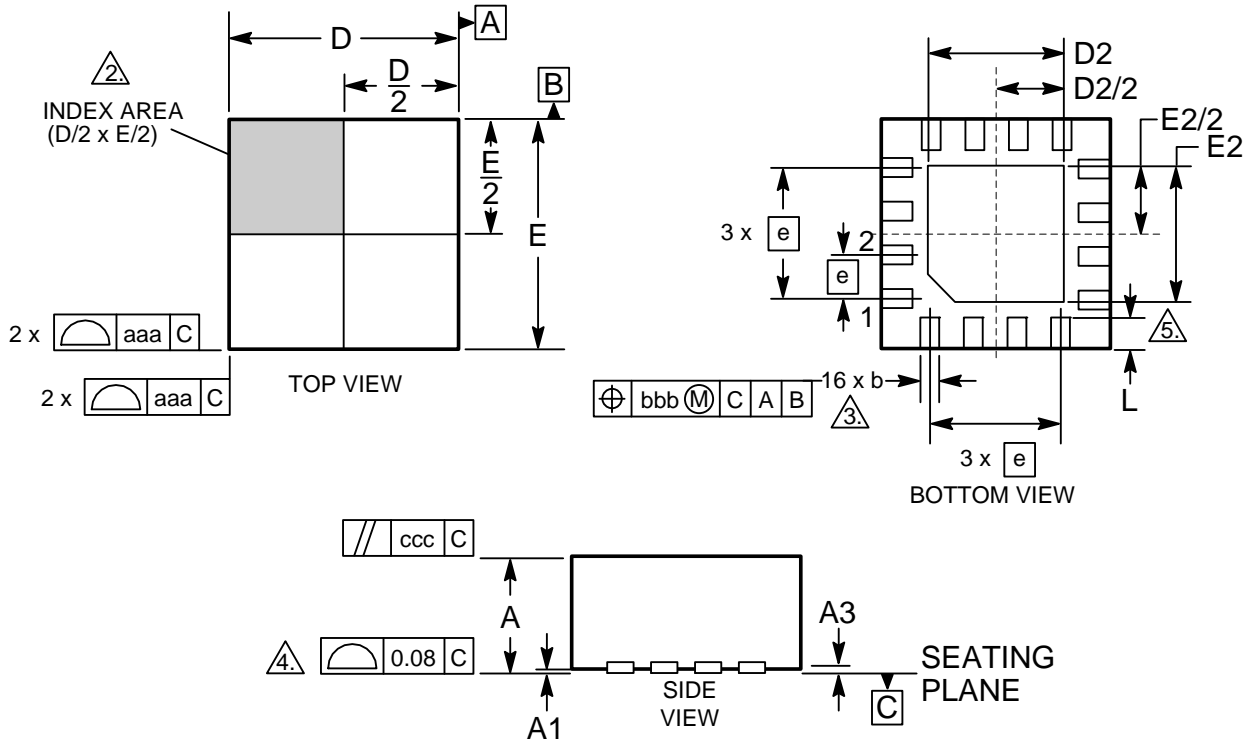

**NOTES:**

1. DIMENSIONING AND TOLERANCING CONFORM TO ASME T14-1994.
- $\triangle 2$  THE TERMINAL #1 AND PAD NUMBERING CONVENTION SHALL CONFORM TO JESD 95-1 SPP-012.
- $\triangle 3$  DIMENSION  $b$  APPLIES TO METALLIZED PAD AND IS MEASURED BETWEEN 0.25 AND 0.30 mm FROM PAD TIP.
- $\triangle 4$  COPLANARITY APPLIES TO THE EXPOSED PADS AS WELL AS THE TERMINALS.
- $\triangle 5$  INSIDE CORNERS OF METALLIZED PAD MAY BE SQUARE OR ROUNDED

DIM	MILLIMETERS	
	MIN	MAX
A	0.80	1.00
A1	0.00	0.05
A3	0.25 REF	
b	0.18	0.30
D	2.90	3.10
D2	0.25	1.95
E	2.90	3.10
E2	0.25	1.95
e	0.50 BSC	
L	0.30	0.50
aaa	0.25	
bbb	0.10	
ccc	0.10	

**AZ10ELT20**  
**AZ100ELT20**

Arizona Microtek, Inc. reserves the right to change circuitry and specifications at any time without prior notice. Arizona Microtek, Inc. makes no warranty, representation or guarantee regarding the suitability of its products for any particular purpose, nor does Arizona Microtek, Inc. assume any liability arising out of the application or use of any product or circuit and specifically disclaims any and all liability, including without limitation special, consequential or incidental damages. Arizona Microtek, Inc. does not convey any license rights nor the rights of others. Arizona Microtek, Inc. products are not designed, intended or authorized for use as components in systems intended to support or sustain life, or for any other application in which the failure of the Arizona Microtek, Inc. product could create a situation where personal injury or death may occur. Should Buyer purchase or use Arizona Microtek, Inc. products for any such unintended or unauthorized application, Buyer shall indemnify and hold Arizona Microtek, Inc. and its officers, employees, subsidiaries, affiliates, and distributors harmless against all claims, costs, damages, and expenses, and reasonable attorney fees arising out of, directly or indirectly, any claim of personal injury or death associated with such unintended or unauthorized use, even if such claim alleges that Arizona Microtek, Inc. was negligent regarding the design or manufacture of the part.