



AZ10LVEL11

AZ100LVEL11

ECL/PECL 1:2 Differential Fanout Buffer

FEATURES

- 265ps Propagation Delay
- 5ps Skew Between Outputs
- High Bandwidth Output Transitions
- Internal Input Pulldown Resistors
- Operating Range of 3.0V to 5.5V
- Direct Replacement for ON Semi MC100LVEL11, MC10EL11 & MC100EL11
- Transistor Count = 51

PACKAGE AVAILABILITY

PACKAGE	PART NUMBER	MARKING	NOTES
SOIC 8	AZ10LVEL11D	AZM10 LVEL11	1,2
SOIC 8	AZ100LVEL11D	AZM100 LVEL11	1,2
SOIC 8 RoHS Compliant / Lead (Pb) Free	AZ10LVEL11D+	AZM10+ LVEL11	1,2
SOIC 8 RoHS Compliant / Lead (Pb) Free	AZ100LVEL11D+	AZM100+ LVEL11	1,2
TSSOP 8	AZ10LVEL11T	AZT LV11	1,2
TSSOP 8	AZ100LVEL11T	AZH LV11	1,2
TSSOP 8 RoHS Compliant / Lead (Pb) Free	AZ100LVEL11T+	AZH+ LV11	1,2

DESCRIPTION

The AZ10/100LVEL11 is a differential 1:2 fanout gate. The device is functionally similar to the E111 device but with higher performance capabilities. Having within-device skews and output transition times significantly improved over the E111, the AZ10/100LVEL11 is ideally suited for those applications that require the ultimate in AC performance.

The differential inputs of the AZ10/100LVEL11 employ clamping circuitry to maintain stability under open input conditions. If the inputs are left open, the Q outputs will go LOW.

NOTE: Specifications in the ECL/PECL tables are valid when thermal equilibrium is established.

LOGIC DIAGRAM AND PINOUT ASSIGNMENT

PIN DESCRIPTION

PIN	FUNCTION
D, \bar{D}	Data Inputs
Q0, Q0, Q1, Q1	Data Outputs
V _{CC}	Positive Supply
V _{EE}	Negative Supply

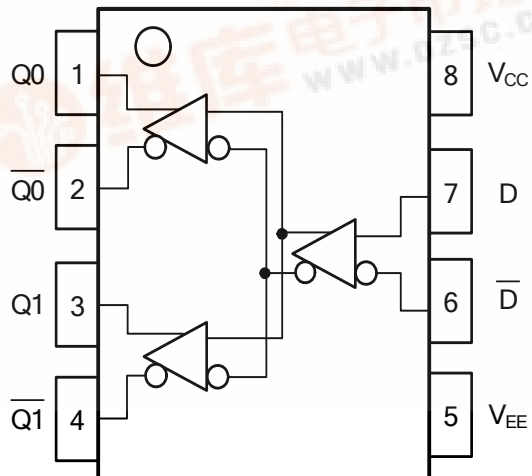

AZ10LVEL11
AZ100LVEL11

Absolute Maximum Ratings are those values beyond which device life may be impaired.

Symbol	Characteristic	Rating	Unit
V _{CC}	PECL Power Supply (V _{EE} = 0V)	0 to +8.0	Vdc
V _I	PECL Input Voltage (V _{EE} = 0V)	0 to +6.0	Vdc
V _{EE}	ECL Power Supply (V _{CC} = 0V)	-8.0 to 0	Vdc
V _I	ECL Input Voltage (V _{CC} = 0V)	-6.0 to 0	Vdc
I _{OUT}	Output Current --- Continuous --- Surge	50 100	mA
T _A	Operating Temperature Range	-40 to +85	°C
T _{STG}	Storage Temperature Range	-65 to +150	°C

10K ECL DC Characteristics (V_{EE} = -3.0V to -5.5V, V_{CC} = GND)

Symbol	Characteristic	-40°C			0°C			25°C			85°C			Unit
		Min	Typ	Max	Min	Typ	Max	Min	Typ	Max	Min	Typ	Max	
V _{OH}	Output HIGH Voltage ¹	-1080		-890	-1020		-840	-980		-810	-910		-720	mV
V _{OL}	Output LOW Voltage ¹	-1950		-1650	-1950		-1630	-1950		-1630	-1950		-1595	mV
V _{IH}	Input HIGH Voltage	-1230		-890	-1170		-840	-1130		-810	-1060		-720	mV
V _{IL}	Input LOW Voltage	-1950		-1500	-1950		-1480	-1950		-1480	-1950		-1445	mV
I _{IL}	Input LOW Current	-150			-150			-150			-150			μA
I _{IH}	Input HIGH Current			150			150			150			150	μA
I _{EE}	Power Supply Current		23	31		24	31		25	31		26	31	mA

1. Each output is terminated through a 50Ω resistor to V_{CC} - 2V.

10K LVPECL DC Characteristics (V_{EE} = GND, V_{CC} = +3.3V)

Symbol	Characteristic	-40°C			0°C			25°C			85°C			Unit
		Min	Typ	Max	Min	Typ	Max	Min	Typ	Max	Min	Typ	Max	
V _{OH}	Output HIGH Voltage ^{1,2}	2220		2410	2280		2460	2320		2490	2390		2580	mV
V _{OL}	Output LOW Voltage ^{1,2}	1350		1650	1350		1670	1350		1670	1350		1705	mV
V _{IH}	Input HIGH Voltage ¹	2070		2410	2130		2460	2170		2490	2240		2580	mV
V _{IL}	Input LOW Voltage ¹	1350		1800	1350		1820	1350		1820	1350		1855	mV
I _{IL}	Input LOW Current	-150			-150			-150			-150			μA
I _{IH}	Input HIGH Current			150			150			150			150	μA
I _{EE}	Power Supply Current		23	31		24	31		25	31		26	31	mA

1. For supply voltages other than 3.3V, use the ECL table values and ADD supply voltage value.

2. Each output is terminated through a 50Ω resistor to V_{CC} - 2V.

10K PECL DC Characteristics (V_{EE} = GND, V_{CC} = +5.0V)

Symbol	Characteristic	-40°C			0°C			25°C			85°C			Unit
		Min	Typ	Max	Min	Typ	Max	Min	Typ	Max	Min	Typ	Max	
V _{OH}	Output HIGH Voltage ^{1,2}	3920		4110	3980		4160	4020		4190	4090		4280	mV
V _{OL}	Output LOW Voltage ^{1,2}	3050		3350	3050		3370	3050		3370	3050		3405	mV
V _{IH}	Input HIGH Voltage ¹	3770		4110	3830		4160	3870		4190	3940		4280	mV
V _{IL}	Input LOW Voltage ¹	3050		3500	3050		3520	3050		3520	3050		3555	mV
I _{IL}	Input LOW Current	-150			-150			-150			-150			μA
I _{IH}	Input HIGH Current			150			150			150			150	μA
I _{EE}	Power Supply Current		23	31		24	31		25	31		26	31	mA

1. For supply voltages other than 5.0V, use the ECL table values and ADD supply voltage value.

2. Each output is terminated through a 50Ω resistor to V_{CC} - 2V.

AZ10LVEL11

AZ100LVEL11

100K ECL DC Characteristics ($V_{EE} = -3.0V$ to $-5.5V$, $V_{CC} = GND$)

Symbol	Characteristic	-40°C			0°C			25°C			85°C			Unit
		Min	Typ	Max	Min	Typ	Max	Min	Typ	Max	Min	Typ	Max	
V_{OH}	Output HIGH Voltage ¹	-1085	-1005	-880	-1025	-955	-880	-1025	-955	-880	-1025	-955	-880	mV
V_{OL}	Output LOW Voltage ¹	-1830	-1695	-1555	-1810	-1705	-1620	-1810	-1705	-1620	-1810	-1705	-1620	mV
V_{IH}	Input HIGH Voltage	-1165		-880	-1165		-880	-1165		-880	-1165		-880	mV
V_{IL}	Input LOW Voltage	-1810		-1475	-1810		-1475	-1810		-1475	-1810		-1475	mV
I_{IL}	Input LOW Current	-150			-150			-150			-150			μA
I_{IH}	Input HIGH Current			150			150			150			150	μA
I_{EE}	Power Supply Current		22	31		23	31		24	31		28	34	mA

- Each output is terminated through a 50 Ω resistor to $V_{CC} - 2V$.

100K LVPECL DC Characteristics ($V_{EE} = GND$, $V_{CC} = +3.3V$)

Symbol	Characteristic	-40°C			0°C			25°C			85°C			Unit
		Min	Typ	Max	Min	Typ	Max	Min	Typ	Max	Min	Typ	Max	
V_{OH}	Output HIGH Voltage ^{1,2}	2215	2295	2420	2275	2345	2420	2275	2345	2420	2275	2345	2420	mV
V_{OL}	Output LOW Voltage ^{1,2}	1470	1605	1745	1490	1595	1680	1490	1595	1680	1490	1595	1680	mV
V_{IH}	Input HIGH Voltage ¹	2135		2420	2135		2420	2135		2420	2135		2420	mV
V_{IL}	Input LOW Voltage ¹	1490		1825	1490		1825	1490		1825	1490		1825	mV
I_{IL}	Input LOW Current	-150			-150			-150			-150			μA
I_{IH}	Input HIGH Current			150			150			150			150	μA
I_{EE}	Power Supply Current		22	31		23	31		24	31		28	34	mA

- For supply voltages other than 3.3V, use the ECL table values and ADD supply voltage value.
- Each output is terminated through a 50 Ω resistor to $V_{CC} - 2V$.

100K PECL DC Characteristics ($V_{EE} = GND$, $V_{CC} = +5.0V$)

Symbol	Characteristic	-40°C			0°C			25°C			85°C			Unit
		Min	Typ	Max	Min	Typ	Max	Min	Typ	Max	Min	Typ	Max	
V_{OH}	Output HIGH Voltage ^{1,2}	3915	3995	4120	3975	4045	4120	3975	4045	4120	3975	4045	4120	mV
V_{OL}	Output LOW Voltage ^{1,2}	3170	3305	3445	3190	3295	3380	3190	3295	3380	3190	3295	3380	mV
V_{IH}	Input HIGH Voltage ¹	3835		4120	3835		4120	3835		4120	3835		4120	mV
V_{IL}	Input LOW Voltage ¹	3190		3525	3190		3525	3190		3525	3190		3525	mV
I_{IL}	Input LOW Current	-150			-150			-150			-150			μA
I_{IH}	Input HIGH Current			150			150			150			150	μA
I_{EE}	Power Supply Current		22	31		23	31		24	31		28	34	mA

- For supply voltages other than 5.0V, use the ECL table values and ADD supply voltage value.
- Each output is terminated through a 50 Ω resistor to $V_{CC} - 2V$.

AC Characteristics ($V_{EE} = -3.0V$ to $-5.5V$, $V_{CC} = GND$ or $V_{EE} = GND$, $V_{CC} = +3.0V$ to $+5.5V$)

Symbol	Characteristic	-40°C			0°C			25°C			85°C			Unit
		Min	Typ	Max	Min	Typ	Max	Min	Typ	Max	Min	Typ	Max	
t_{PLH} / t_{PHL}	Propagation Delay to Output	135	260	335	185	260	335	190	265	340	215	310	365	ps
t_{SKEW}	Within-Device Skew ¹ Duty Cycle Skew ²		5 5			5 5	20 20		5 5	20 20		5 5	20 20	ps
$V_{PP}(AC)$	Minimum Input Swing ³	150			150			150			150			mV
V_{CMR}	Common Mode Range ⁴	$V_{EE} + 1.2$		$V_{CC} - 0.2$	$V_{EE} + 1.2$		$V_{CC} - 0.2$	$V_{EE} + 1.2$		$V_{CC} - 0.2$	$V_{EE} + 1.2$		$V_{CC} - 0.2$	V
t_r / t_f	Rise/Fall Time 20 – 80%	100		260	100		260	100		260	100		260	ps

- Within-device skew defined as identical transitions on similar paths through a device.
- Duty cycle skew is the difference between a t_{PLH} and t_{PHL} propagation delay through a device.
- V_{PP} is the minimum peak-to-peak differential input swing for which AC parameters guaranteed. The device has a DC gain of ≈ 40 .
- The V_{CMR} range is referenced to the most positive side of the differential input signal. Normal operation is obtained if the HIGH level falls within the specified range and the peak-to-peak voltage lies between $V_{PP}(\text{min})$ and $1V$.

AZ10LVEL11
AZ100LVEL11

Fig. 1 Typical Output Swing Versus Frequency for AZ100LVEL11

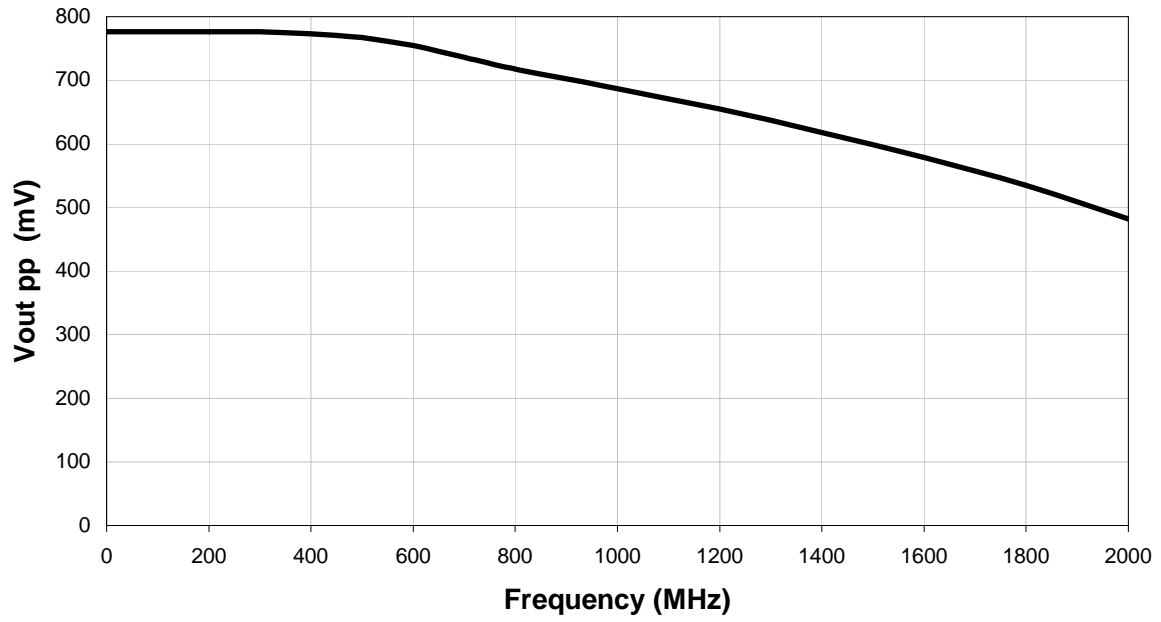

AZ10LVEL11
AZ100LVEL11

**PACKAGE DIAGRAM
SOIC 8**

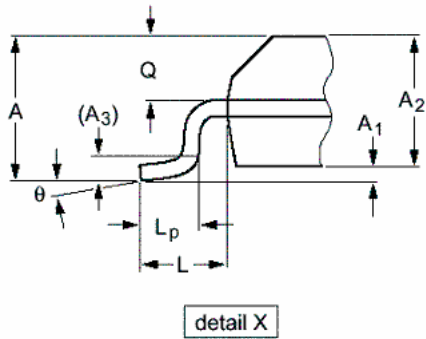
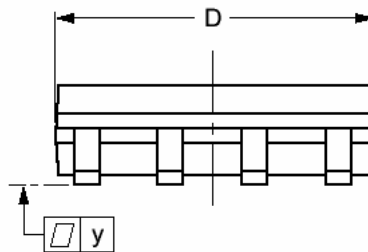
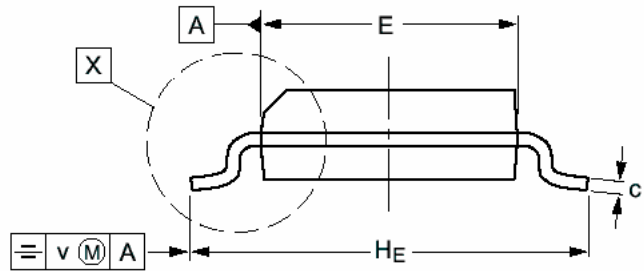
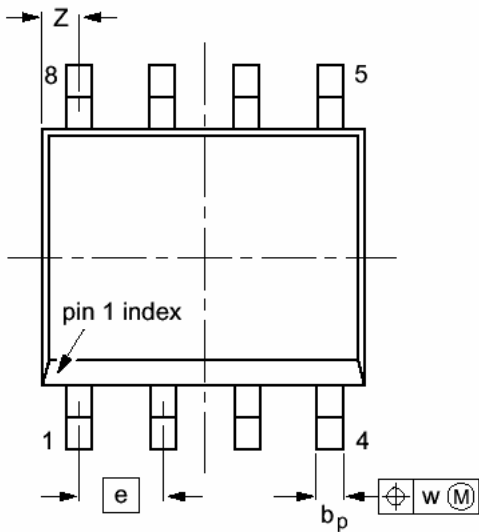

DIM	MILLIMETERS		INCHES	
	MIN	MAX	MIN	MAX
A		1.75		0.069
A ₁	0.10	0.25	0.004	0.010
A ₂	1.25	1.45	0.049	0.057
A ₃	0.25		0.01	
b _p	0.36	0.49	0.014	0.019
c	0.19	0.25	0.0075	0.0100
D	4.8	5.0	0.19	0.20
E	3.8	4.0	0.15	0.16
e	1.27		0.050	
H _E	5.80	6.20	0.228	0.244
L	1.05		0.041	
L _p	0.40	1.00	0.016	0.039
Q	0.60	0.70	0.024	0.028
v	0.25		0.01	
w	0.25		0.01	
y	0.10		0.004	
Z	0.30	0.70	0.012	0.028
θ	0°	8°	0°	8°

- NOTES:
1. DIMENSIONS D AND E DO NOT INCLUDE MOLD PROTRUSION.
 2. MAXIMUM MOLD PROTRUSION FOR D IS 0.15mm.
 3. MAXIMUM MOLD PROTRUSION FOR E IS 0.25mm.

AZ10LVEL11
AZ100LVEL11

**PACKAGE DIAGRAM
TSSOP 8**

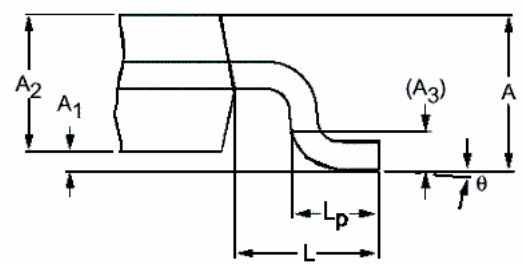
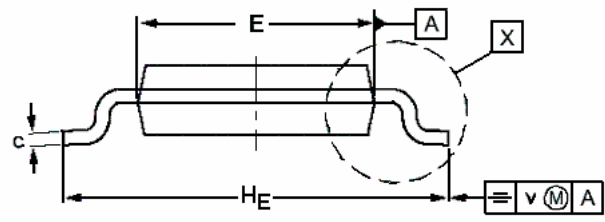
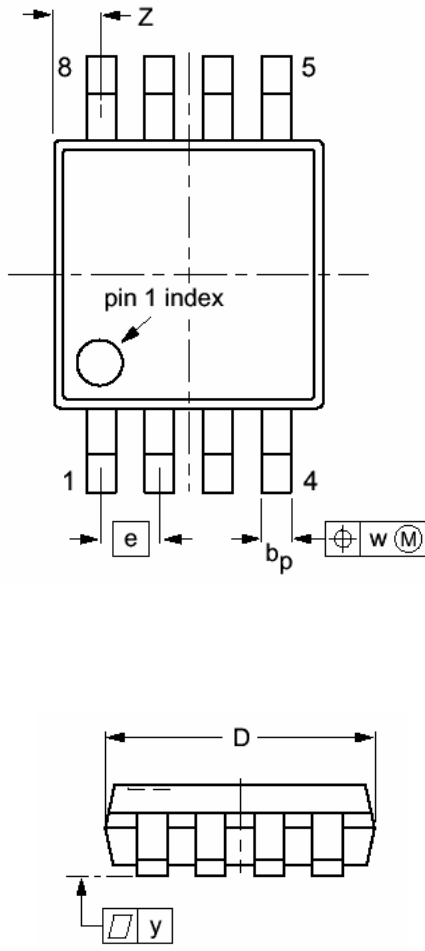

detail X

DIM	MILLIMETERS	
	MIN	MAX
A		1.10
A ₁	0.05	0.15
A ₂	0.80	0.95
A ₃	0.25	
b _p	0.25	0.45
c	0.15	0.28
D	2.90	3.10
E	2.90	3.10
e	0.65	
H _E	4.70	5.10
L	0.94	
L _p	0.40	0.70
v	0.10	
w	0.10	
y	0.10	
Z	0.35	0.70
θ	0°	6°

- NOTES:
1. DIMENSIONS D AND E DO NOT INCLUDE MOLD PROTRUSION.
 2. MAXIMUM MOLD PROTRUSION FOR D IS 0.15mm.
 3. MAXIMUM MOLD PROTRUSION FOR E IS 0.25mm.

AZ10LVEL11
AZ100LVEL11

Arizona Microtek, Inc. reserves the right to change circuitry and specifications at any time without prior notice. Arizona Microtek, Inc. makes no warranty, representation or guarantee regarding the suitability of its products for any particular purpose, nor does Arizona Microtek, Inc. assume any liability arising out of the application or use of any product or circuit and specifically disclaims any and all liability, including without limitation special, consequential or incidental damages. Arizona Microtek, Inc. does not convey any license rights nor the rights of others. Arizona Microtek, Inc. products are not designed, intended or authorized for use as components in systems intended to support or sustain life, or for any other application in which the failure of the Arizona Microtek, Inc. product could create a situation where personal injury or death may occur. Should Buyer purchase or use Arizona Microtek, Inc. products for any such unintended or unauthorized application, Buyer shall indemnify and hold Arizona Microtek, Inc. and its officers, employees, subsidiaries, affiliates, and distributors harmless against all claims, costs, damages, and expenses, and reasonable attorney fees arising out of, directly or indirectly, any claim of personal injury or death associated with such unintended or unauthorized use, even if such claim alleges that Arizona Microtek, Inc. was negligent regarding the design or manufacture of the part.