

Xinger®

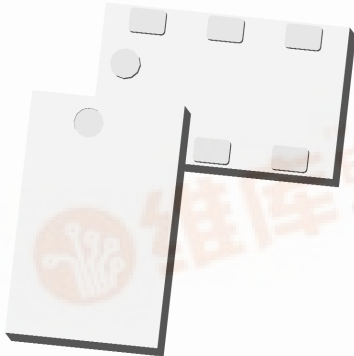

Ultra Low Profile 0805 Balun 50Ω to 100Ω Balanced

Description

The BD0810J50100A00 is a low profile sub-miniature balanced to unbalanced transformer designed for differential inputs and output locations on next generation wireless chipsets in an easy to use surface mount package covering the GSM frequency. The BD0810J50100A00 is ideal for high volume manufacturing and is higher performance than traditional ceramic and lumped element baluns. The BD0810J50100A00 has an unbalanced port impedance of 50Ω and a 100Ω balanced port impedance. This transformation enables single ended signals to be applied to differential ports on modern semiconductors. The output ports have equal amplitude (-3dB) with 180 degree phase differential. The BD0810J50100A00 is available on tape and reel for pick and place high volume manufacturing.

Detailed Electrical Specifications: Specifications subject to change without notice.

Features:	Parameter	ROOM (25°C)			Unit
		Min.	Typ.	Max	
• 800 – 1000 MHz	Frequency	800		1000	MHz
• 0.7mm Height Profile	Unbalanced Port Impedance		50		Ω
• 50 Ohm to 2 x 50 Ohm	Balanced Port Impedance		100		Ω
• GSM	Return Loss	13	15		dB
• Low Insertion Loss	Insertion Loss*		0.70	0.95	dB
• Input to Output DC Isolation	Amplitude Balance		0.2	0.4	dB
• Surface Mountable	Phase Balance		1	2	Degrees
• Tape & Reel	CMRR		39		dB
• Non-conductive Surface	Power Handling			2	Watts
• RoHS Compliant	Operating Temperature	-55		+85	°C

* Insertion Loss stated at room temperature (Insertion Loss is approximately 0.1 dB higher at +85 °C)

Outline Drawing

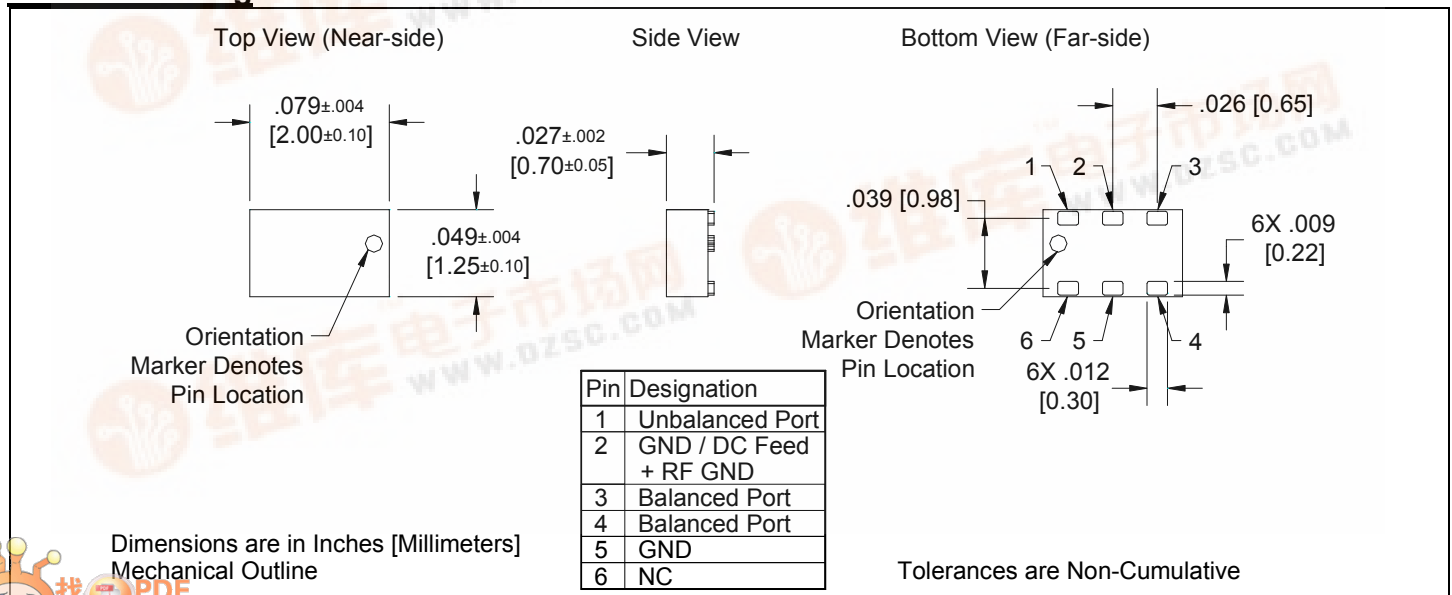

Model BD0810J50100A00

Rev. C



Typical Broadband Performance: 0 GHz. to 8.5 GHz.

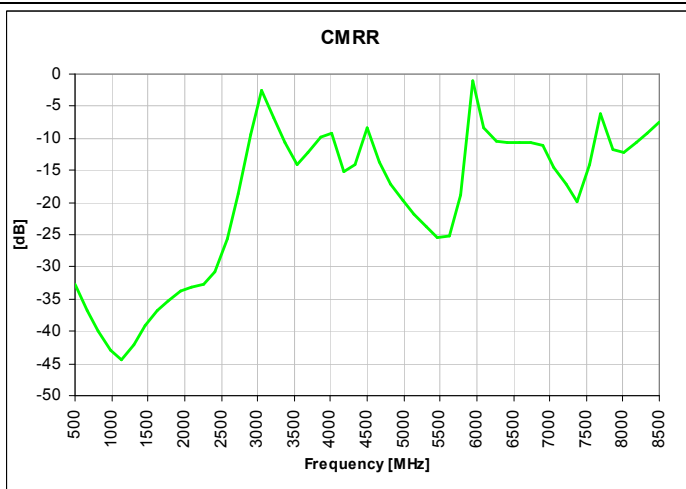
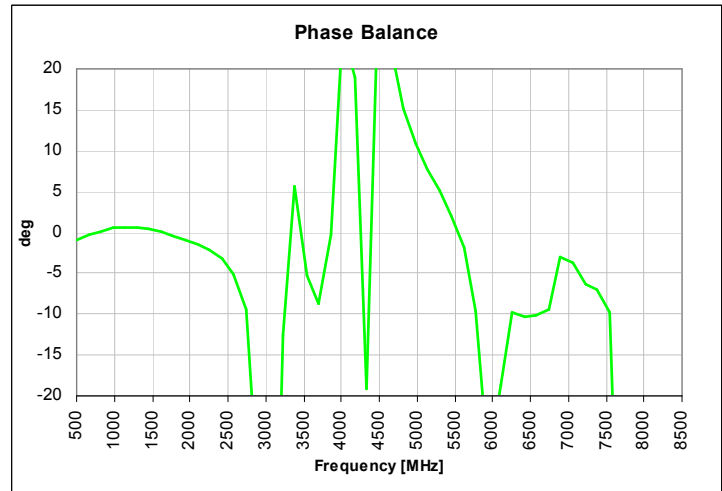
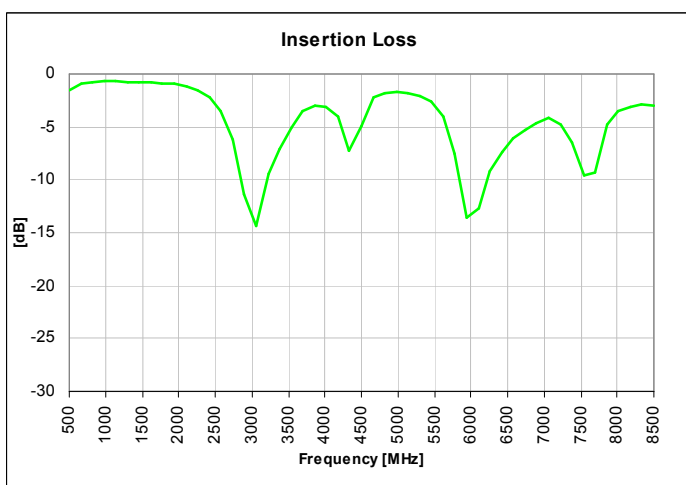
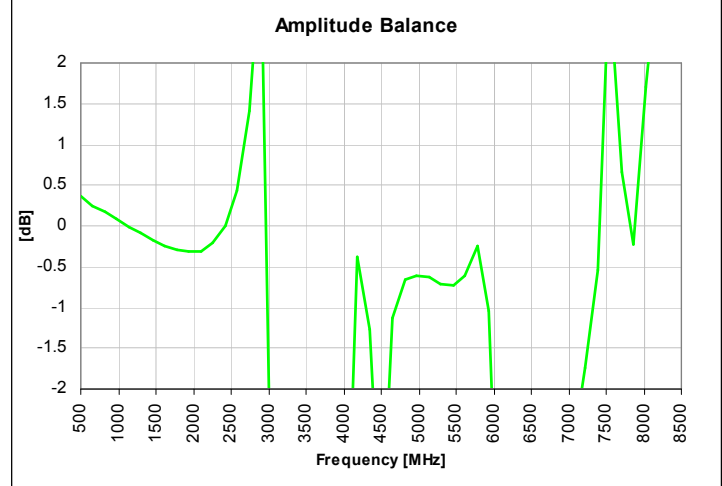
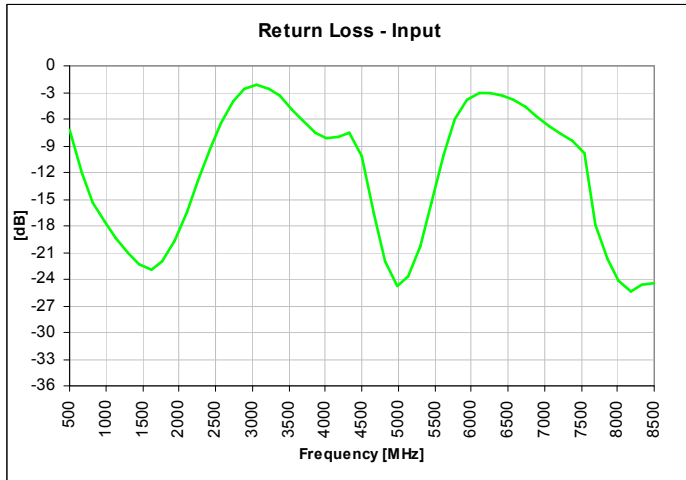

USA/Canada: (315) 432-8909
Toll Free: (800) 411-6596

Available on Tape and Reel for Pick and Place



Typical Performance: 700 MHz. to 1100 MHz.

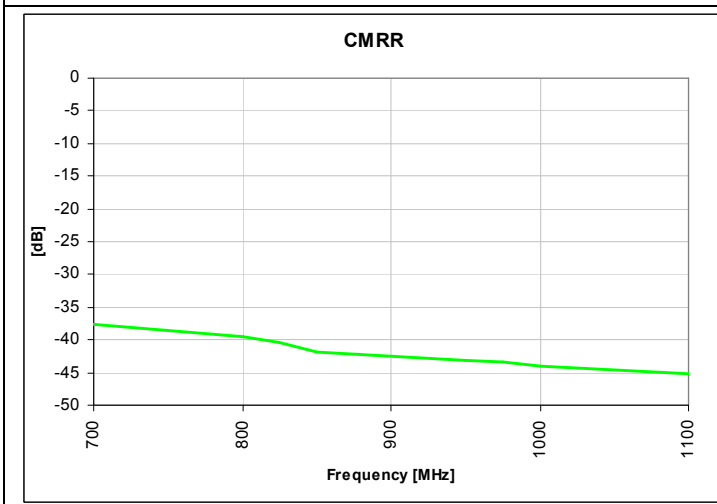
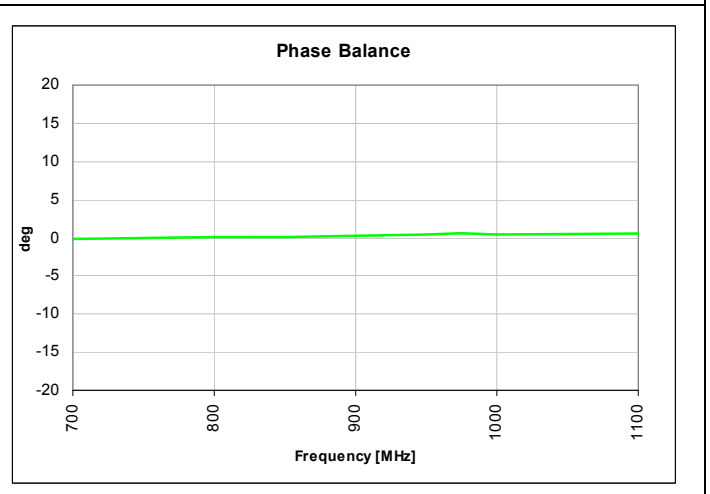
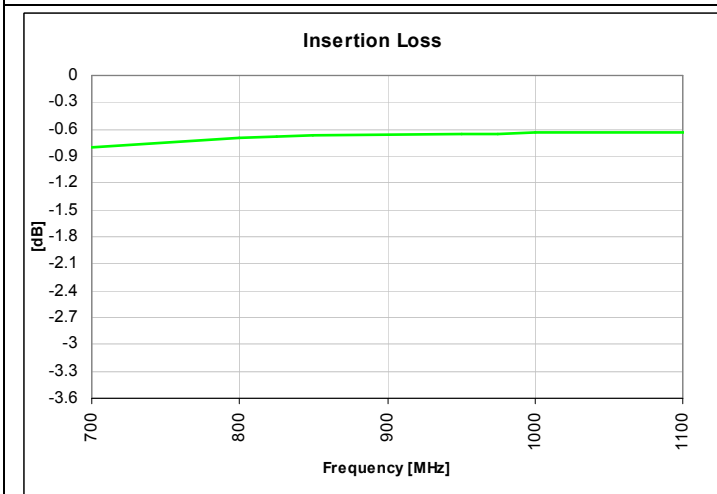
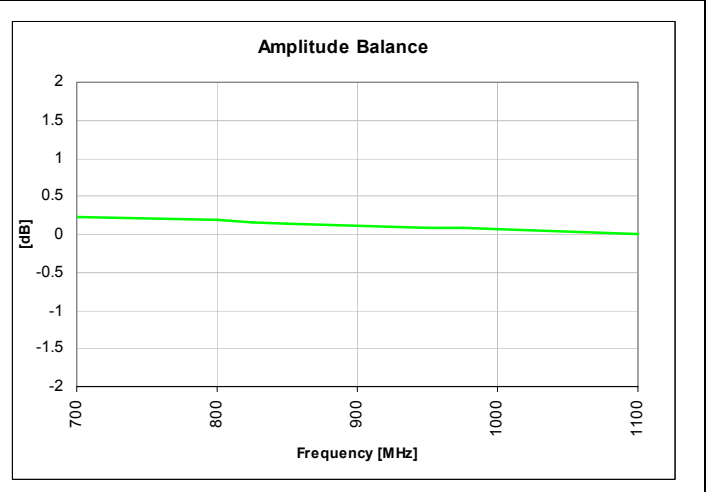
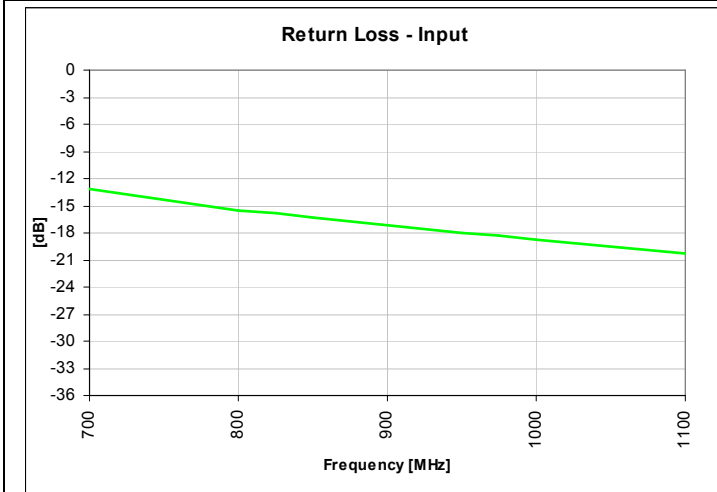

Mounting Configuration:

In order for Xinger surface mount components to work optimally, the proper impedance transmission lines must be used to connect to the RF ports. If this condition is not satisfied, insertion loss, Isolation and VSWR may not meet published specifications.

All of the Xinger components are constructed from ceramic filled PTFE composites which possess excellent electrical and mechanical stability having X and Y thermal coefficient of expansion (CTE) of 17 ppm/°C.

An example of the PCB footprint used in the testing of these parts is shown below. An example of a DC-biased footprint is also shown below. In specific designs, the transmission line widths need to be adjusted to the unique dielectric coefficients and thicknesses as well as varying pick and place equipment tolerances.

No Bias Footprint

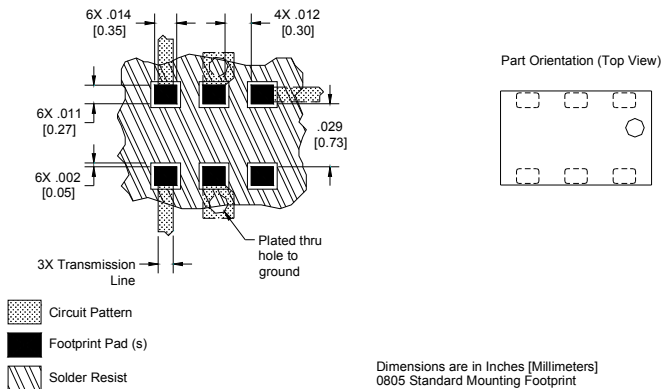

DC Bias Footprint

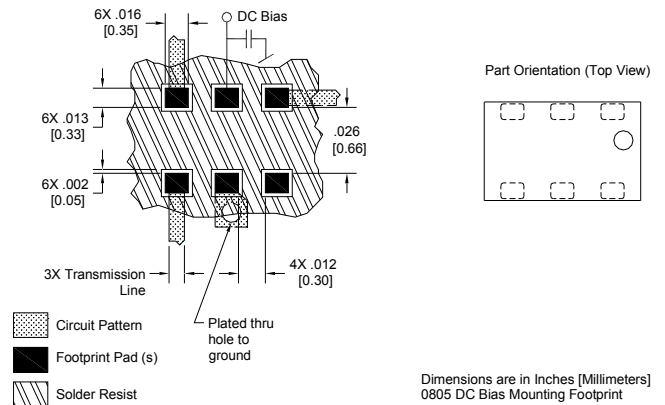

Packaging and Ordering Information

Parts are available in reel and are packaged per EIA 481-2. Parts are oriented in tape and reel as shown below. Minimum order quantities are 4000 per reel. See Model Numbers below for further ordering information.

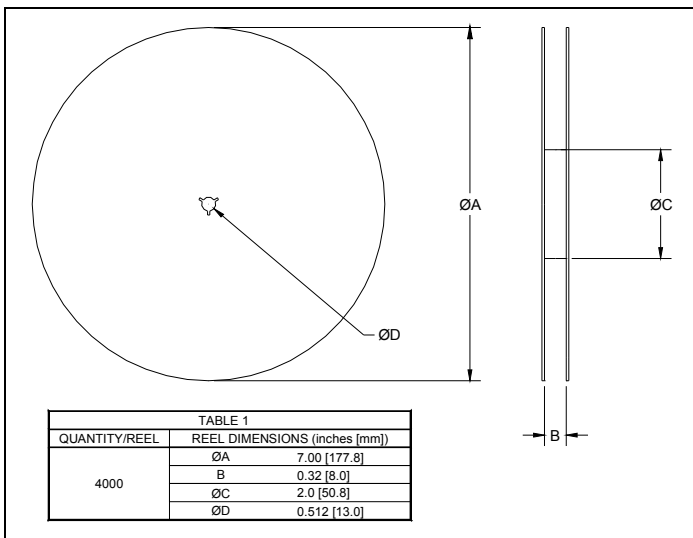
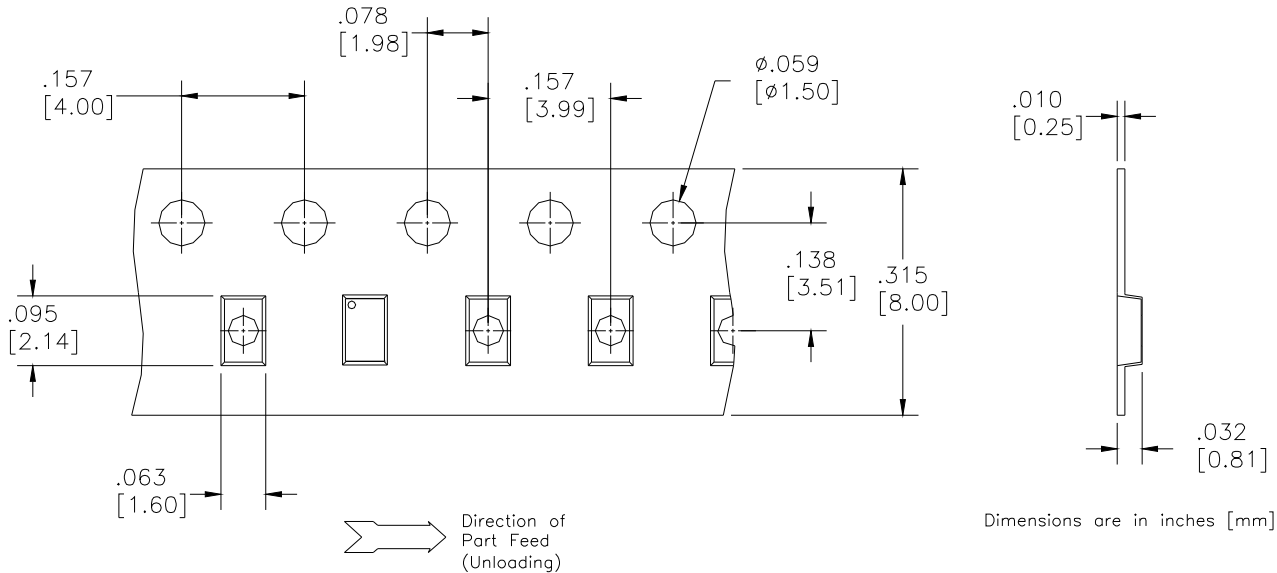

BD 2425 J 50 100 A 00

Function	Frequency	Package Dimensions	Unbalanced Impedance	Balanced Impedance + Coupling	Plating Finish	Codes
B = Balun BD = Balun + DC F = Filter FB = Filter / Balun C = 3dB Coupler DC = Directional J = RF Jumper X = RF cross over	0110 = 100 – 1000 MHz 0810 = 800 – 1000 MHz 0922 = 950 – 2150 MHz 0826 = 800 – 6200 MHz 1222 = 1200 – 2200 MHz 1416 = 1400 – 1600 MHz 1722 = 1700 – 2200 MHz 2326 = 2300 – 2600 MHz 2425 = 2400 – 2500 MHz 3150 = 3100 – 5000 MHz 3436 = 3400 – 3600 MHz 4859 = 4800 – 5900MHz 5153 = 5100 – 5300 MHz 5159 = 5100 – 5900 MHz 5759 = 5700 – 5900 MHz	A = 150 x 150 mils <small>(4mm x 4mm)</small> C = 120 x 120 mils <small>(3mm x 3mm)</small> E = 100 x 80 mils <small>(2.5mm x 2mm)</small> J = 80 x 50 mils <small>(2mm x 1.25mm)</small> L = 60 x 30 mils <small>(1.5mm x 0.75mm)</small> N = 40 x 40 mils <small>(1mm x 1mm)</small>	50 = 50 Ohm 75 = 75 Ohm	25 = 25 Ω Balanced 30 = 30 Ω Balanced 50 = 50 Ω Balanced 75 = 75 Ω Balanced 100 = 100 Ω Balanced 150 = 150 Ω Balanced 200 = 200 Ω Balanced 300 = 300 Ω Balanced 400 = 400 Ω Balanced 03 = 3dB Hybrid 10 = 10dB Directional 20 = 20dB Directional	A = Gold P = Tin-Lead	

