

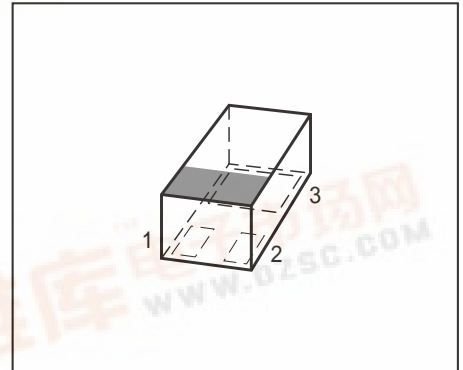

BFR740L3

NPN Silicon Germanium RF Transistor

- High gain ultra low noise RF transistor
- Provides outstanding performance for a wide range of wireless applications up to 10 GHz and more
- Ideal for CDMA and WLAN applications
- Outstanding noise figure $F = 0.5$ dB at 1.8 GHz
Outstanding noise figure $F = 0.8$ dB at 6 GHz
- High maximum stable gain
 $G_{ms} = 24$ dB at 1.8 GHz
- Gold metallization for extra high reliability
- 150 GHz f_T -Silicon Germanium technology



ESD (Electrostatic discharge) sensitive device, observe handling precaution!

Type	Marking	Pin Configuration			Package
BFR740L3	R7	1=B	2=C	3=E	TSLP-3-8

Maximum Ratings

Parameter	Symbol	Value	Unit
Collector-emitter voltage $T_A > 0^\circ\text{C}$ $T_A \leq 0^\circ\text{C}$	V_{CE0}	4 3.5	V
Collector-emitter voltage	V_{CES}	13	
Collector-base voltage	V_{CBO}	13	
Emitter-base voltage	V_{EBO}	1.2	
Collector current	I_C	30	mA
Base current	I_B	3	
Total power dissipation ¹⁾ $T_S \leq 94^\circ\text{C}$	P_{tot}	160	mW
Junction temperature	T_j	150	$^\circ\text{C}$
Ambient temperature	T_A	-65 ... 150	
Storage temperature	T_{stg}	-65 ... 150	

¹⁾ T_S is measured on the collector lead at the soldering point to the pcb



Thermal Resistance

Parameter	Symbol	Value	Unit
Junction - soldering point ¹⁾	R_{thJS}	≤ 350	K/W

Electrical Characteristics at $T_A = 25^\circ\text{C}$, unless otherwise specified

Parameter	Symbol	Values			Unit
		min.	typ.	max.	

DC Characteristics

Collector-emitter breakdown voltage $I_C = 1 \text{ mA}, I_B = 0$	$V_{(BR)CEO}$	4	4.7	-	V
Collector-emitter cutoff current $V_{CE} = 13 \text{ V}, V_{BE} = 0$	I_{CES}	-	-	30	μA
Collector-base cutoff current $V_{CB} = 5 \text{ V}, I_E = 0$	I_{CBO}	-	-	100	nA
Emitter-base cutoff current $V_{EB} = 0.5 \text{ V}, I_C = 0$	I_{EBO}	-	-	3	μA
DC current gain $I_C = 25 \text{ mA}, V_{CE} = 3 \text{ V}, \text{ pulse measured}$	h_{FE}	160	250	400	-

¹⁾For calculation of R_{thJA} please refer to Application Note Thermal Resistance

Electrical Characteristics at $T_A = 25^\circ\text{C}$, unless otherwise specified

Parameter	Symbol	Values			Unit
		min.	typ.	max.	
AC Characteristics (verified by random sampling)					
Transition frequency $I_C = 25\text{ mA}$, $V_{CE} = 3\text{ V}$, $f = 2\text{ GHz}$	f_T	-	42	-	GHz
Collector-base capacitance $V_{CB} = 3\text{ V}$, $f = 1\text{ MHz}$, $V_{BE} = 0$, emitter grounded	C_{cb}	-	0.1	0.16	pF
Collector emitter capacitance $V_{CE} = 3\text{ V}$, $f = 1\text{ MHz}$, $V_{BE} = 0$, base grounded	C_{ce}	-	0.18	-	
Emitter-base capacitance $V_{EB} = 0.5\text{ V}$, $f = 1\text{ MHz}$, $V_{CB} = 0$, collector grounded	C_{eb}	-	0.38	-	
Noise figure $I_C = 8\text{ mA}$, $V_{CE} = 3\text{ V}$, $f = 1.8\text{ GHz}$, $Z_S = Z_{Sopt}$ $I_C = 8\text{ mA}$, $V_{CE} = 3\text{ V}$, $f = 6\text{ GHz}$, $Z_S = Z_{Sopt}$	F	-	0.5 0.8	-	dB
Power gain, maximum stable ¹⁾ $I_C = 25\text{ mA}$, $V_{CE} = 3\text{ V}$, $Z_S = Z_{Sopt}$, $Z_L = Z_{Lopt}$, $f = 1.8\text{ GHz}$	G_{ms}	-	24	-	dB
Power gain, maximum available ¹⁾ $I_C = 25\text{ mA}$, $V_{CE} = 3\text{ V}$, $Z_S = Z_{Sopt}$, $Z_L = Z_{Lopt}$, $f = 6\text{ GHz}$	G_{ma}	-	14.5	-	dB
Transducer gain $I_C = 25\text{ mA}$, $V_{CE} = 3\text{ V}$, $Z_S = Z_L = 50\ \Omega$, $f = 1.8\text{ GHz}$ $f = 6\text{ GHz}$	$ S_{21e} ^2$	-	21.5 12	-	dB
Third order intercept point at output ²⁾ $V_{CE} = 3\text{ V}$, $I_C = 25\text{ mA}$, $Z_S = Z_L = 50\ \Omega$, $f = 1.8\text{ GHz}$	IP_3	-	25	-	dBm
1dB Compression point at output $I_C = 25\text{ mA}$, $V_{CE} = 3\text{ V}$, $Z_S = Z_L = 50\ \Omega$, $f = 1.8\text{ GHz}$	P_{-1dB}	-	11	-	

¹⁾ $G_{ma} = |S_{21e} / S_{12e}| (k - (k^2 - 1)^{1/2})$, $G_{ms} = |S_{21e} / S_{12e}|$
²⁾ IP3 value depends on termination of all intermodulation frequency components.
Termination used for this measurement is 50Ω from 0.1 MHz to 6 GHz

Total power dissipation $P_{tot} = f(T_S)$

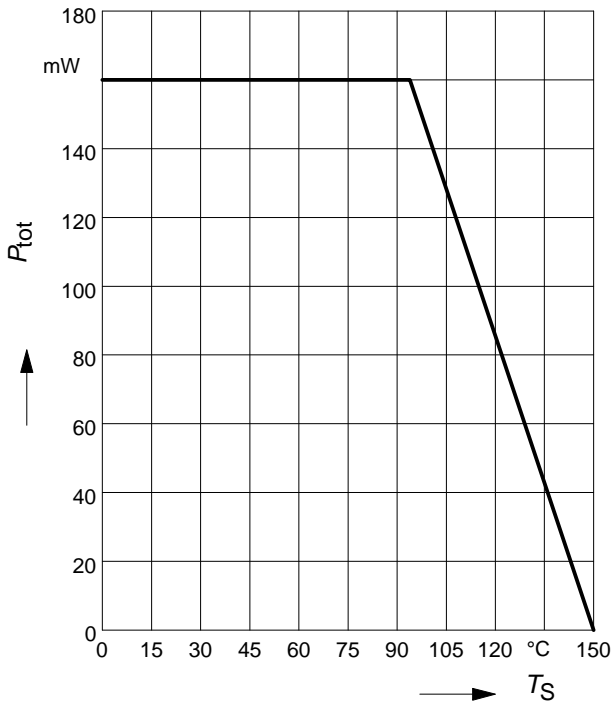

Permissible Pulse Load $R_{thJS} = f(t_p)$

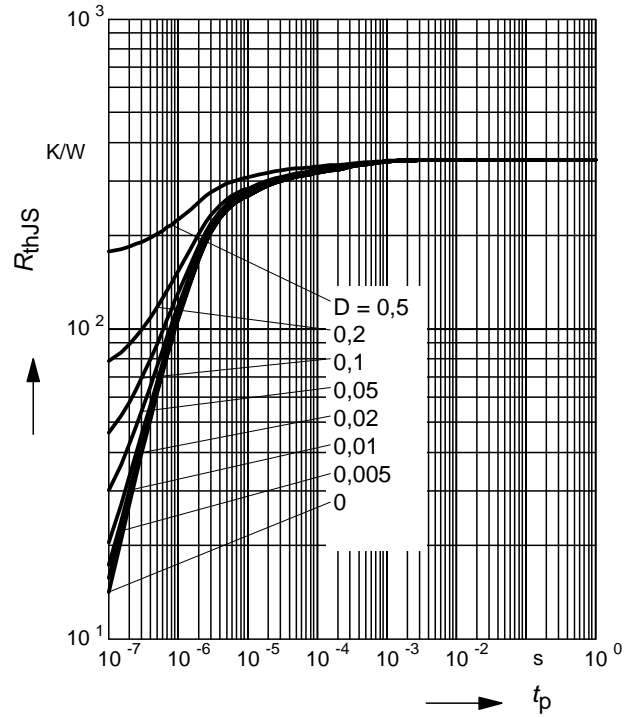

Permissible Pulse Load

$P_{totmax}/P_{totDC} = f(t_p)$

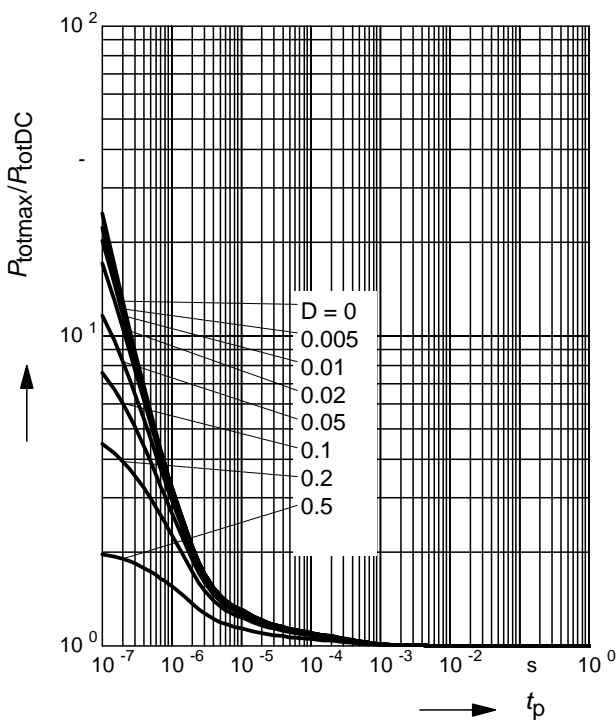

Collector-base capacitance $C_{cb} = f(V_{CB})$

$f = 1 \text{ MHz}$

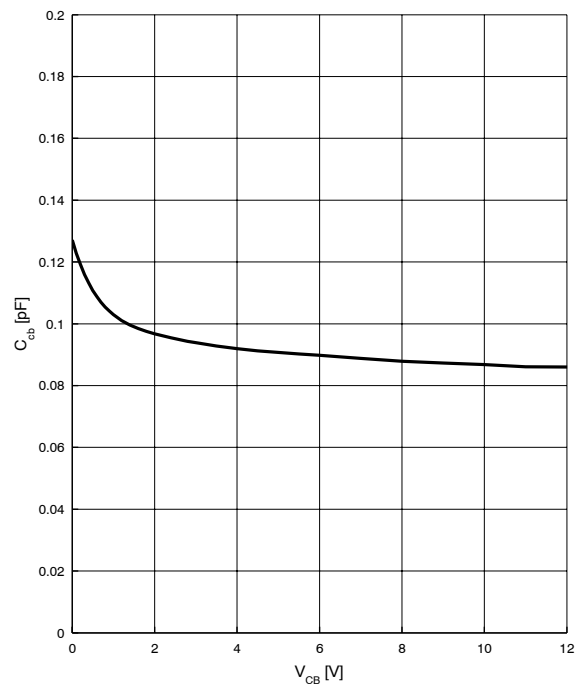

Third order Intercept Point $IP_3 = f(I_C)$

(Output, $Z_S = Z_L = 50 \Omega$)

$V_{CE} = \text{parameter}$, $f = 1.8 \text{ GHz}$

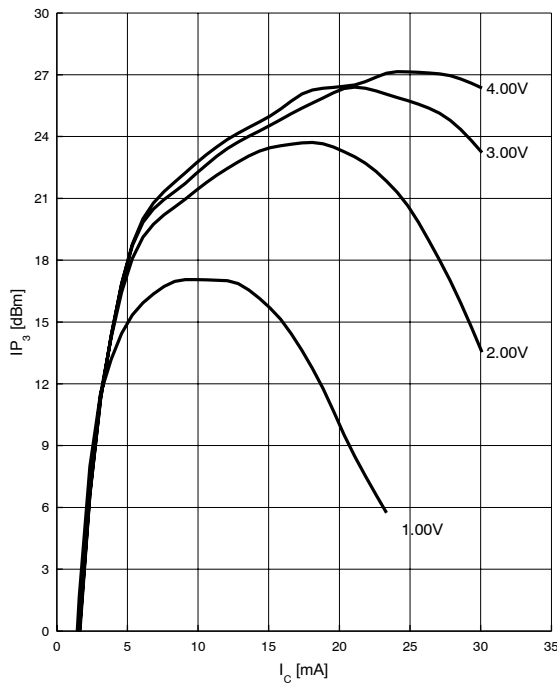

Transition frequency $f_T = f(I_C)$

$V_{CE} = \text{parameter}$, $f = 2 \text{ GHz}$

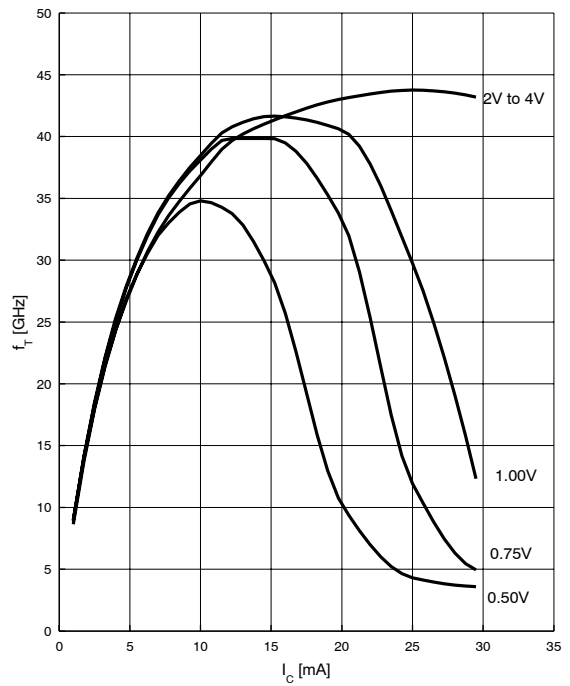

Power gain $G_{ma}, G_{ms} = f(f)$

$V_{CE} = 3 \text{ V}$, $I_C = 25 \text{ mA}$

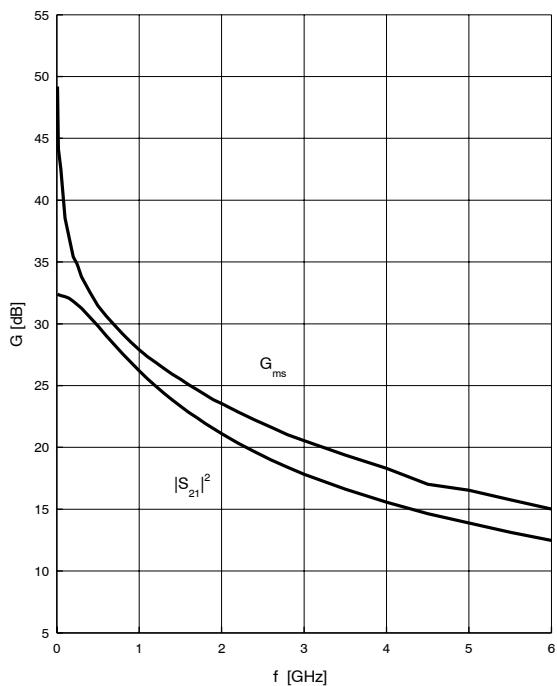

Power gain $G_{ma}, G_{ms} = f(I_C)$

$V_{CE} = 3 \text{ V}$

$f = \text{parameter}$

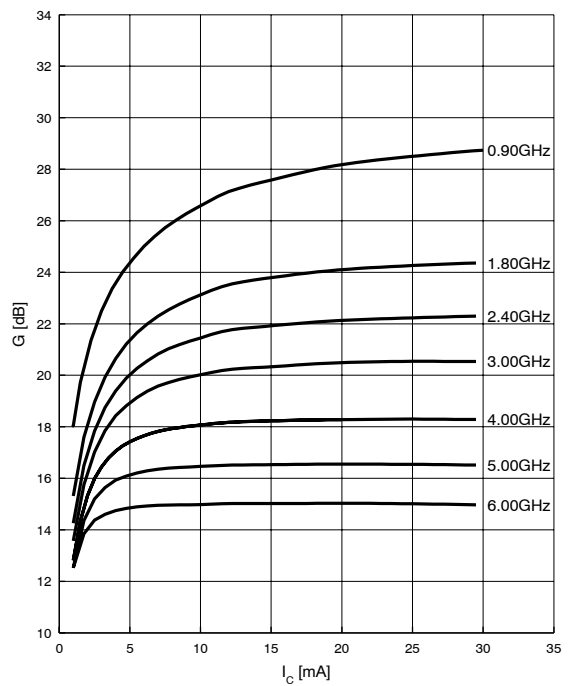

Power gain G_{ma} , $G_{ms} = f(V_{CE})$

$I_C = 25 \text{ mA}$

$f = \text{parameter}$

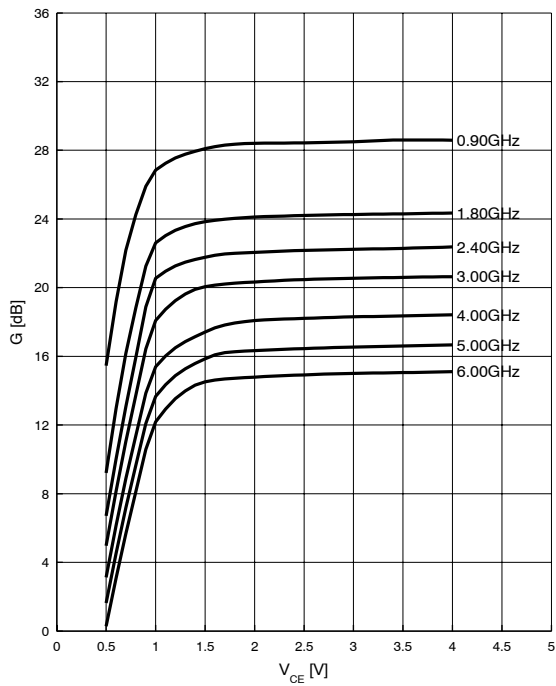

Noise figure $F = f(I_C)$

$V_{CE} = 3 \text{ V}$, $f = \text{parameter}$

$Z_S = Z_{Sopt}$

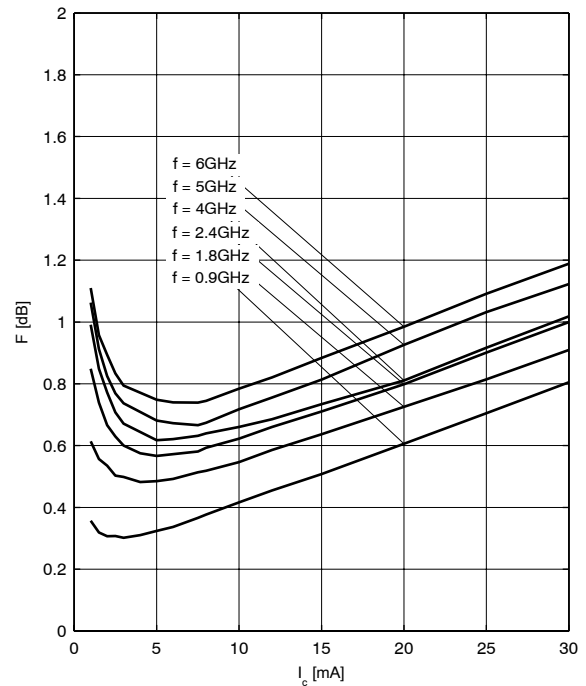

Noise figure $F = f(I_C)$

$V_{CE} = 3 \text{ V}$, $f = 1.8 \text{ GHz}$

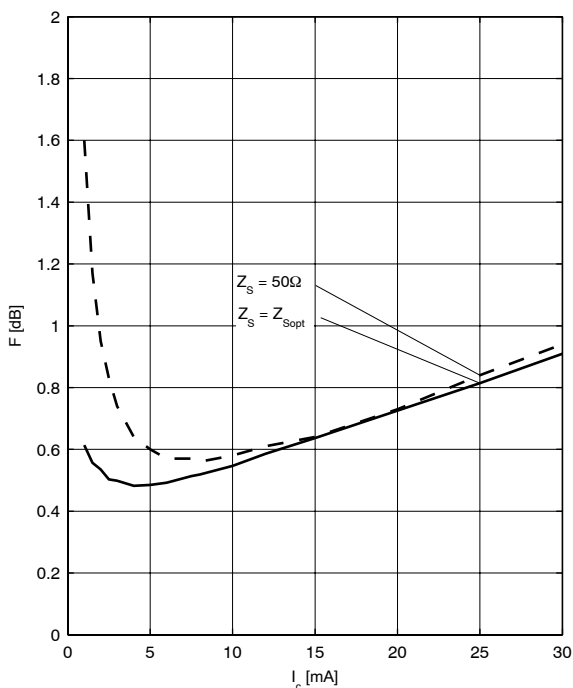

Noise figure $F = f(f)$

$V_{CE} = 3 \text{ V}$, $Z_S = Z_{Sopt}$

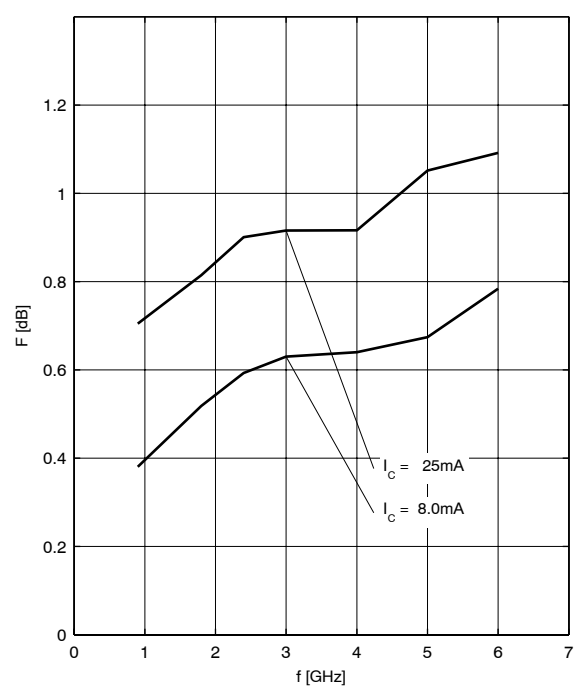

Source impedance for min.

noise figure vs. frequency

$V_{CE} = 3\text{ V}$, $I_C = 8\text{ mA} / 25\text{ mA}$

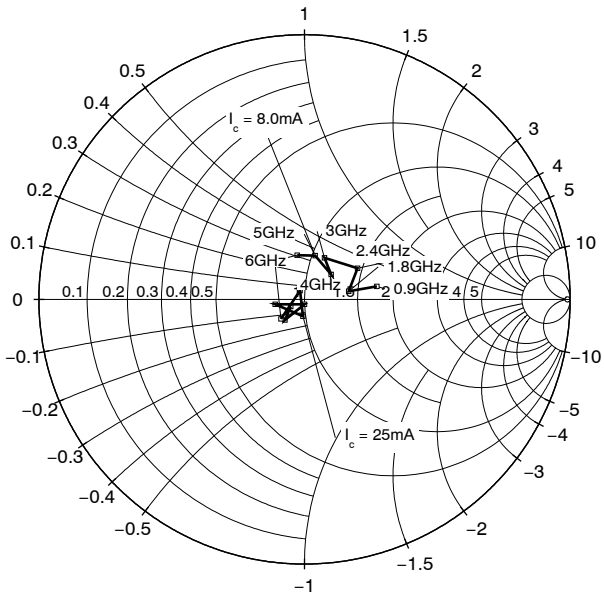

Package Outline

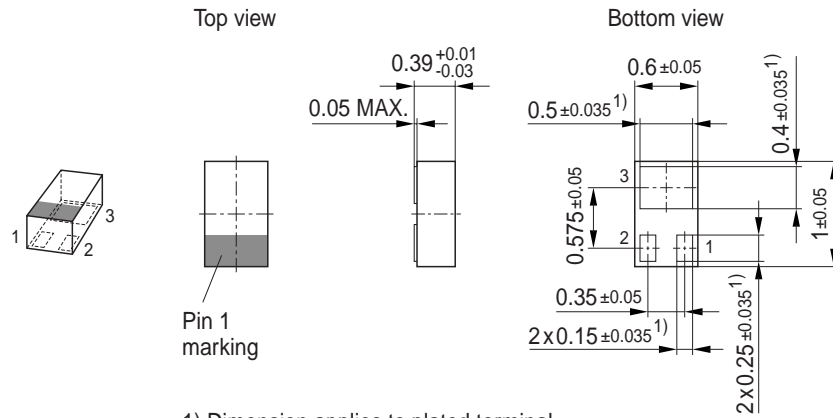

Foot Print

For board assembly information please refer to Infineon website "Packages"

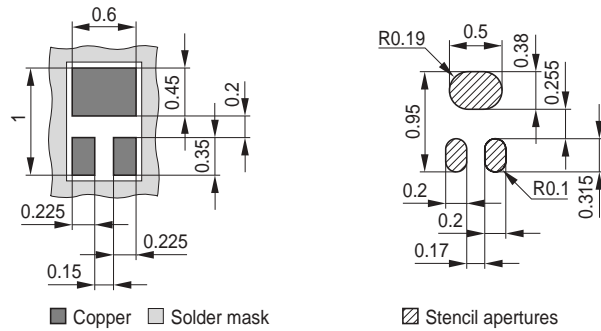

Marking Layout

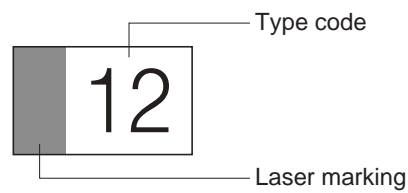

Standard Packing

Reel ø180 mm = 15.000 Pieces/Reel

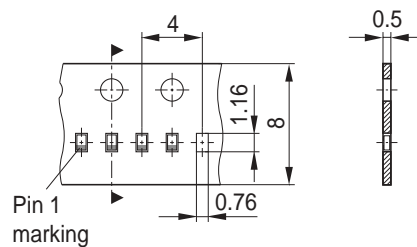

Published by Infineon Technologies AG,
St.-Martin-Strasse 53,
81669 München
© Infineon Technologies AG 2005.
All Rights Reserved.

Attention please!

The information herein is given to describe certain components and shall not be considered as a guarantee of characteristics.

Terms of delivery and rights to technical change reserved.

We hereby disclaim any and all warranties, including but not limited to warranties of non-infringement, regarding circuits, descriptions and charts stated herein.

Information

For further information on technology, delivery terms and conditions and prices please contact your nearest Infineon Technologies Office (www.infineon.com).

Warnings

Due to technical requirements components may contain dangerous substances. For information on the types in question please contact your nearest Infineon Technologies Office.

Infineon Technologies Components may only be used in life-support devices or systems with the express written approval of Infineon Technologies, if a failure of such components can reasonably be expected to cause the failure of that life-support device or system, or to affect the safety or effectiveness of that device or system. Life support devices or systems are intended to be implanted in the human body, or to support and/or maintain and sustain and/or protect human life. If they fail, it is reasonable to assume that the health of the user or other persons may be endangered.