



# DS80EP100

## 5 to 12.5 Gbps, Power-Saver Equalizer for Backplanes and Cables

### General Description

National's Power-saver equalizer compensates for transmission medium losses and minimizes medium-induced deterministic jitter. Performance is guaranteed over the full range of 5 to 12.5 Gbps. The DS80EP100 requires no power to operate. The equalizer operates anywhere in the data path to minimize media-induced deterministic jitter in both FR4 traces and cable applications. Symmetric I/O structures support full duplex or half duplex applications. Linear compensation is provided independent of line coding or protocol. The device is ideal for both bi-level and multi-level signaling.

The equalizer is available in a 6 pin leadless LLP package with a space saving 2.2 mm X 2.5 mm footprint. This tiny package provides maximum flexibility in placement and routing of the Power-saver equalizer.

### Features

- 5 to 12.5 Gbps Operation
- No Power or Ground Required
- Equalization effective anywhere in data path
- Equalizes CML, LV-PECL, LVDS signals
- Symmetric I/O structures provide equal boost for bi-directional operation
- 7 dB Maximum Boost
- Code independent, 8b/10b or Scrambled
- Supports both bi-level and multi-level signaling
- Extends reach over backplanes and cables
- Compatible with PCI-Express Gen1 and Gen2
- Compatible with XAUI
- Will operate in series with existing active Equalizer
- Easy to handle 6 pin LLP

### Simplified Application Diagram

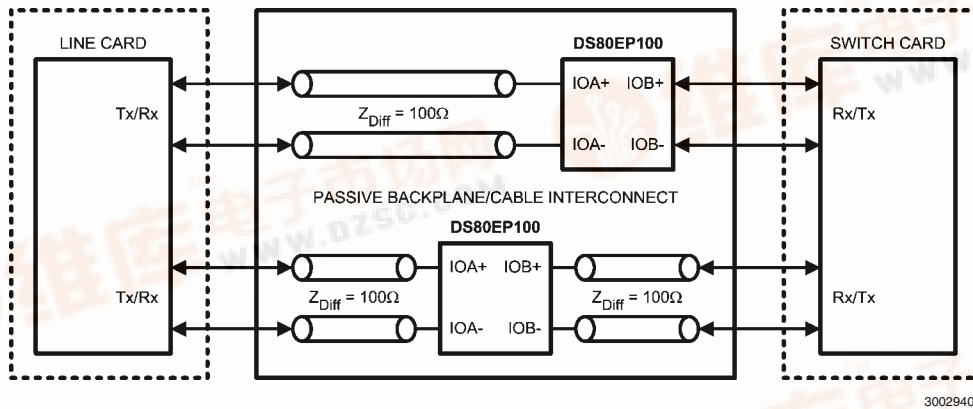

**Note:** The DS80EP100 provides the flexibility of passing the data from either side of the device. It can be placed anywhere in the data path.



## Pin Descriptions

| Pin Name                           | Pin Number  | I/O Type | Description                  |
|------------------------------------|-------------|----------|------------------------------|
| <b>High speed differential I/O</b> |             |          |                              |
| IOA-<br>IOA+                       | 3<br>1      | I/O      | Symmetric differential I/O   |
| IOB-<br>IOB+                       | 4<br>6      | I/O      | Symmetric differential I/O   |
| NC<br>Exposed<br>Pad               | 2, 5<br>DAP | N/A      | Reserved.<br>Do not connect. |

Note: I = Input / O = Output

## Connection Diagram

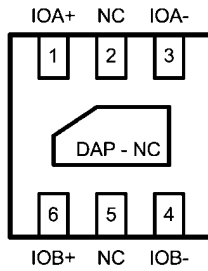

30029405  
**Bottom View Shown**  
**2.2mm x 2.5mm 6-Pin LLP Package**  
**Order Number DS80EP100**  
**See NS Package Number SDA14A**

**Absolute Maximum Ratings** (Note 1)

If Military/Aerospace specified devices are required, please contact the National Semiconductor Sales Office/Distributors for availability and specifications.

## INPUT/OUTPUT

|                                    |                 |
|------------------------------------|-----------------|
| (IOA+ and IOB+) or (IOA- and IOB-) | +2V             |
| (IOA+ and IOA-) or (IOB+ and IOB-) | +4V             |
| (IOA+ and IOB-) or (IOA- and IOB+) | +4V             |
| Junction Temperature               | +150°C          |
| Storage Temperature                | -65°C to +150°C |

Lead Temperature  
Soldering, 4 sec

+260°C

ESD Rating

HBM, 1.5 kΩ, 100 pF

1.3kV

**Recommended Operating Conditions**

|                     | Min | Typ | Max  | Units |
|---------------------|-----|-----|------|-------|
| Ambient Temperature | -40 | 25  | +85  | °C    |
| Bit Rate            | 5   |     | 12.5 | Gbps  |

**Electrical Characteristics** (Note 6)

Over recommended operating conditions unless other specified. All parameters are guaranteed by test, statistical analysis or design.

| Symbol   | Parameter                                | Conditions   | Min                                 | Typ<br>(Note 2) | Max  | Units |
|----------|--|--|-------------------------------------|-----------------|------|-------|
| $V_{IN}$ | Input voltage swing                      | (Note 3)   |                                     | 1000            | 3600 | mVp-p |
|          | Equalization                             | 6.25 GHz relative to 100MHz  |                                     | 6               |      | dB    |
| $R_{LI}$ | Differential input return loss           | 100 MHz – 6.25 GHz, with fixture's effect de-embedded                              |                                     | 15              |      | dB    |
| $R_{LO}$ | Differential output return loss          | 100 MHz – 6.25 GHz, with fixture's effect de-embedded IOA+, or IOB+ = static high. |                                     | 15              |      | dB    |
| $R_{IN}$ | Input Impedance                          | Differential across IOA+ and IOA-, or IOB+ and IOB-, ZLOAD = 100Ω                  |                                     | 100             |      | Ω     |
| $R_O$    | Output Impedance                         | Differential across IOA+ and IOA-, or IOB+ and IOB-, ZSOURCE = 100Ω                |                                     | 100             |      | Ω     |
|          | Through Response                         | Relative to ideal load, see Figure 2 for setup                                     | See Figure 3 and Table 1 for limits |                 |      |       |
| R1       | Resistance IOA+ to IOA- and IOB+ to IOB- | No load, high impedance on all ports   |                                     | 150             |      | Ω     |
| R2       | Resistance IOA+ to IOB+ and IOA- to IOB- | No load, high impedance on all ports   |                                     | 50              |      | Ω     |
| R3       | Resistance IOA+ to IOB- and IOA- to IOB+ | No load, high impedance on all ports   |                                     | 150             |      | Ω     |
|          | DC Gain<br>(IOA/IOB or IOB/IOA)          | ZLOAD = 100Ω   |                                     | 0.4             |      |       |
| DJ1      | Residual deterministic jitter            | 5 Gbps, 20 in of 6mil microstrip FR4<br>See (Note 4)                               |                                     | 0.15            |      | Ulp-p |
| DJ2      | Residual deterministic jitter            | 6.25 Gbps, 20 in of 6mil microstrip FR4<br>See (Notes 4, 5)                        |                                     | 0.15            | 0.20 | Ulp-p |
| DJ3      | Residual deterministic jitter            | 8 Gbps, 20 in of 6mil microstrip FR4<br>See (Notes 4, 5)                           |                                     | 0.15            | 0.20 | Ulp-p |
| DJ4      | Residual deterministic jitter            | 10 Gbps, 20 in of 6mil microstrip FR4<br>See (Note 4)                              |                                     | 0.15            |      | Ulp-p |
| DJ5      | Residual deterministic jitter            | 12.5 Gbps, 14 in of 6mil microstrip FR4<br>See (Note 4)                            |                                     | 0.15            |      | Ulp-p |

**Note 1:** "Absolute Maximum Ratings" indicate limits beyond which damage to the device may occur, including inoperability and degradation of device reliability and/or performance. Functional operation of the device and/or non-degradation at the Absolute Maximum Ratings or other conditions beyond those indicated in the Recommended Operating Conditions is not implied. The Recommended Operating Conditions indicate conditions at which the device is functional and the device should not be operated beyond such conditions.

**Note 2:** Typical values represent most likely parametric norms,  $T_A = +25 \text{ degC}$ , and at the Recommended Operation Conditions at the time of product characterization and are not guaranteed.

**Note 3:** Differential signal to Equalizer, measured at the input to a transmission line, see point A of *Figure 1*. The transmission line is  $Z_0 = 100\Omega$ , 6-mil, microstrip in FR4 material.

**Note 4:** Deterministic jitter is measured at the differential outputs (point C of *Figure 1*), minus the deterministic jitter before the test channel (point A of *Figure 1*). Test pattern: PRBS- 7 .

**Note 5:** Specification is guaranteed by characterization and is not tested in production.

**Note 6:** The Electrical Characteristics tables list guaranteed specifications under the listed Recommended Operating Conditions except as otherwise modified or specified by the Electrical Characteristics Conditions and/or Notes. Typical specifications are estimations only and are not guaranteed.

## Test Setup Diagrams

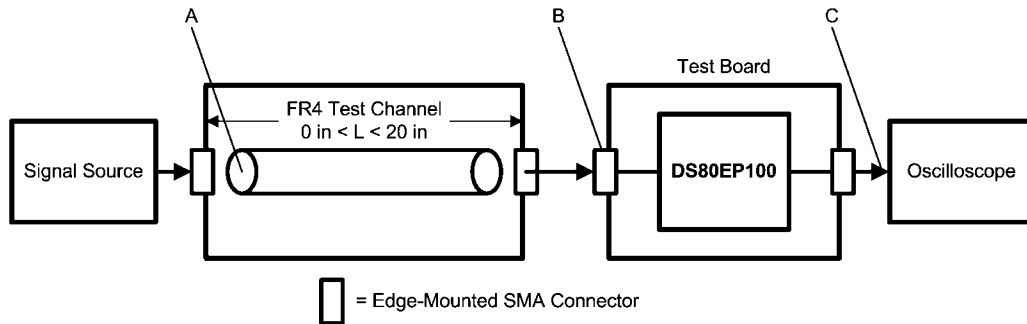

FIGURE 1. Transient Test Setup Diagram

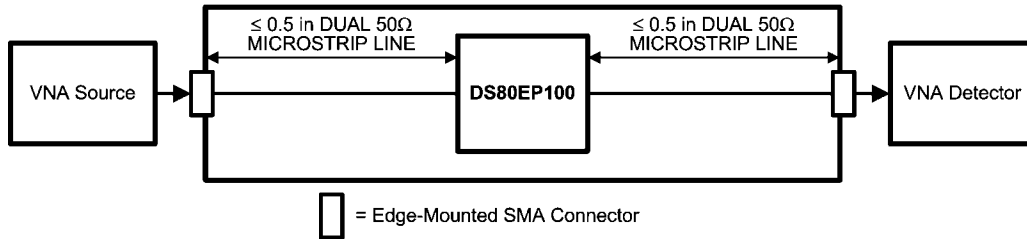

FIGURE 2. Frequency Response Test Circuit

## Typical Equalizer Transfer Function

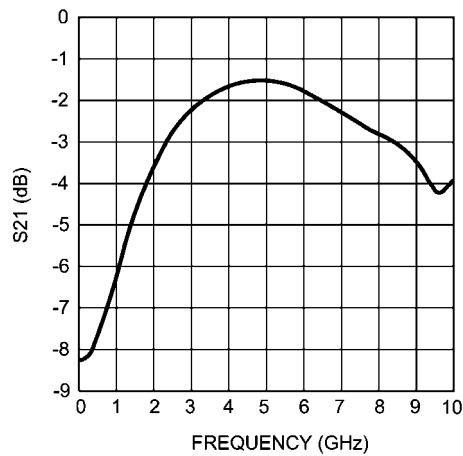
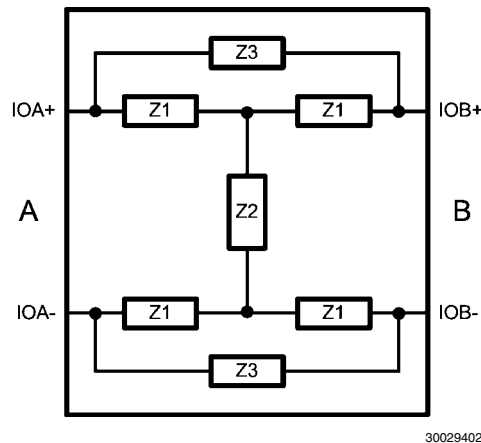

FIGURE 3. Typical Equalizer Transfer Function

**Table 1. Typical Through Response**

| Frequency (GHz) | DS80EP100 Attenuation Typ (dB) |
|-----------------|--------------------------------|
| 0.1             | -8.25                          |
| 0.5             | -7.64                          |
| 1               | -6.12                          |
| 1.5             | -4.68                          |
| 2               | -3.57                          |
| 3               | -2.22                          |
| 4               | -1.66                          |
| 5               | -1.53                          |
| 6               | -1.77                          |
| 7               | -2.28                          |
| 8               | -2.8                           |
| 9               | -3.47                          |
| 10              | -3.91                          |

**Block Diagram****FIGURE 4. Simplified Block Diagram****Application Information****DS80EP100 DEVICE DESCRIPTION**

The DS80EP100 Power-Saver equalizer is a passive network circuit composed of resistive, capacitive, and inductive components (See *Figure 4*). A Differential bridged T-network compensates for the transmission medium losses and minimizes medium-induced deterministic jitter with FR4 and cables. The equalizer attenuates low frequency signals and is a bandpass filter at the resonant frequency. The response is linear and symmetric.

**I/O TERMINATIONS**

The DS80EP100 I/O impedance is 100Ω differential. The equalizer is designed for 100Ω-balanced differential signals and is not intended for single-ended transmission.

**LINEAR COMPENSATION**

The unique linear compensation feature of the DS80EP100 combined with the tiny package allows maximum flexibility in placement. The equalizer can be placed anywhere in the data

path and will provide the same compensation at the receiving circuit. (See Simplified Application Diagram)

**SYMMETRIC I/O STRUCTURES**

The symmetry of the passive equalization network allows bi-directional operation. Signals receive equal compensation regardless of the direction of data flow. (See Simplified Block Diagram).

**PCB LAYOUT CONSIDERATIONS FOR DIFFERENTIAL PAIRS AND NO CONNECT PADS**

The differential I/Os must have a controlled differential impedance of 100Ω. It is preferable to route all differential lines exclusively on one layer of the board. The use of vias should be avoided if possible. If vias must be used, they should be used sparingly and must be placed symmetrically for each side of a given differential pair. Differential signals should be routed away from other signals and noise sources on the printed circuit board. Pin 2, Pin 5, and the center DAP have to be left as no connect. Therefore, do not connect the landing pads of these pins to the power or ground plane. See AN-1187 for additional information on the LLP package.

# Typical Performance Characteristics

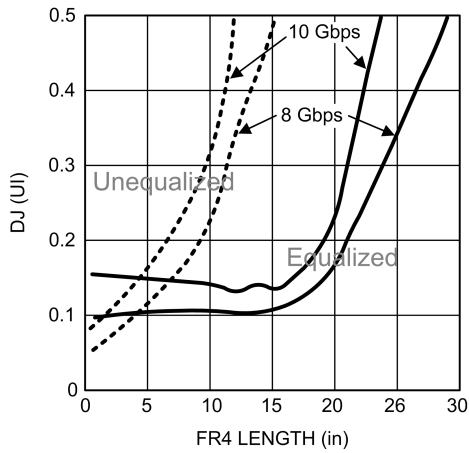

30029407  
Residual Deterministic Jitter vs. FR4 Length

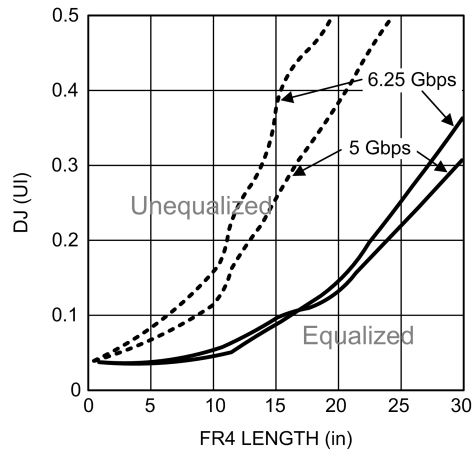

30029408  
Residual Deterministic Jitter vs. FR4 Length

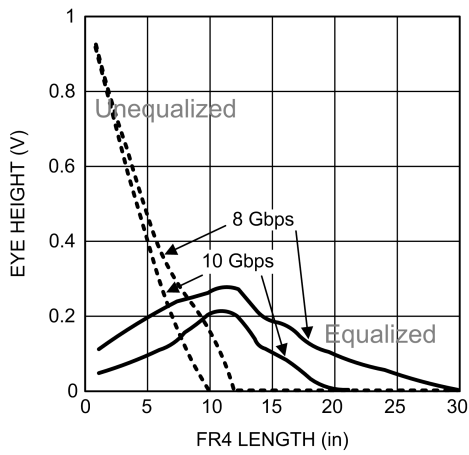

30029409  
Eye Height vs. FR4 Length

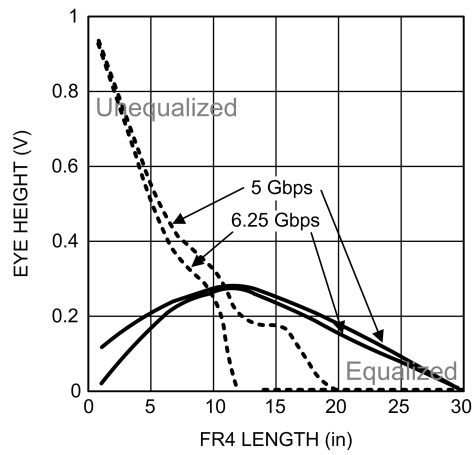

30029410  
Eye Height vs. FR4 Length

### Typical Eye Diagrams — Includes Transmitter Setup, Interconnect, and Device Total Jitter

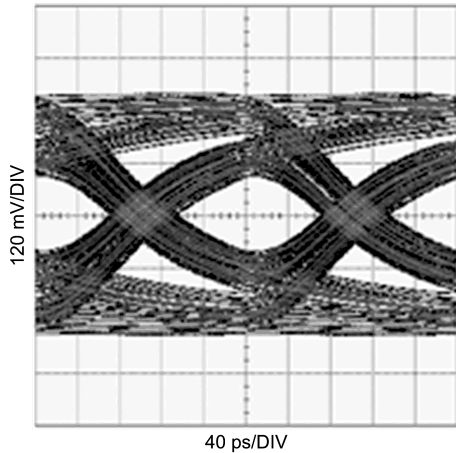

30029411

FIGURE 5. Unequalized Signal (20in FR4, 5Gbps, PRBS7)

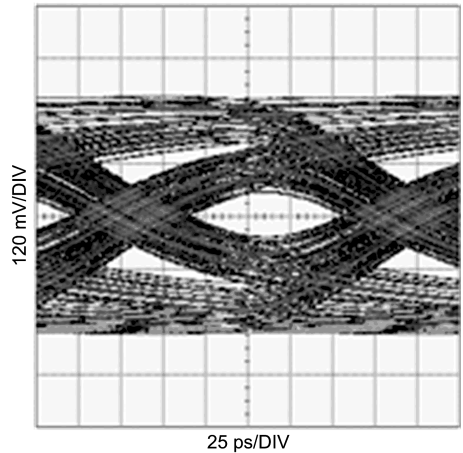

30029414

FIGURE 8. Unequalized Signal (20in FR4, 6.25Gbps, PRBS7)

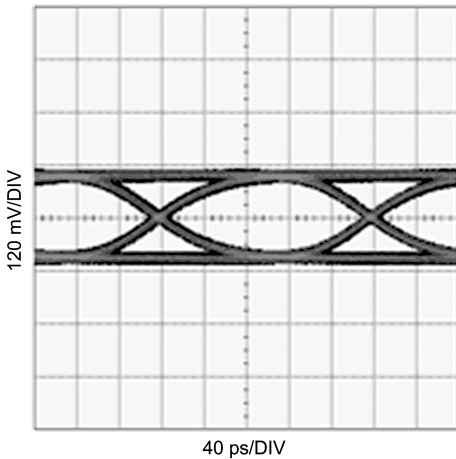

30029412

FIGURE 6. Equalized Signal (20in FR4, 5Gbps, PRBS7)

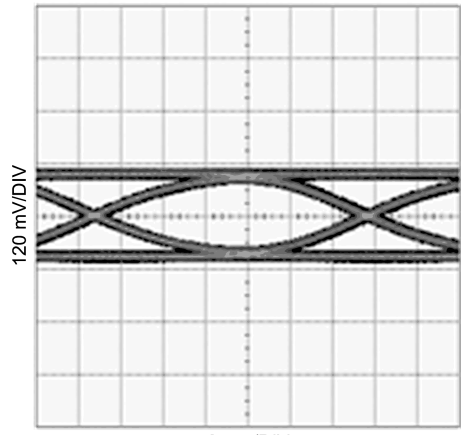

30029415

FIGURE 9. Equalized Signal (20in FR4, 6.25Gbps, PRBS7)

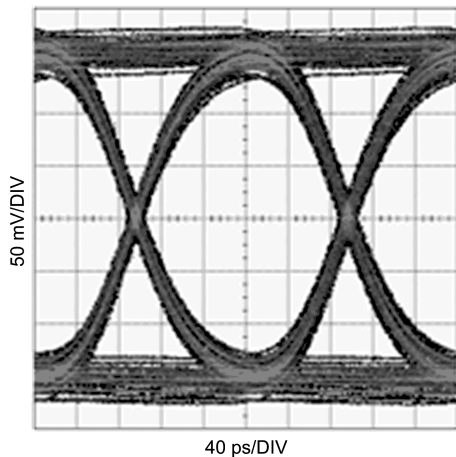

30029413

FIGURE 7. Equalized Signal (Zoom) (20in FR4, 5Gbps, PRBS7)

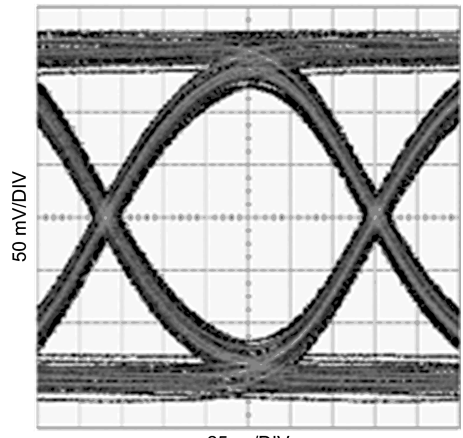

30029416

FIGURE 10. Equalized Signal (Zoom) (20in FR4, 6.26Gbps, PRBS7)



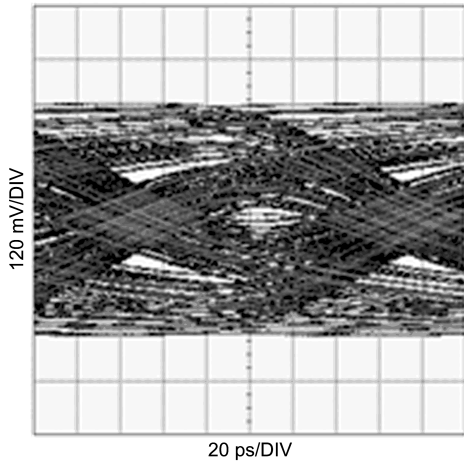

30029417

FIGURE 11. Unequalized Signal (20in FR4, 8Gbps, PRBS7)

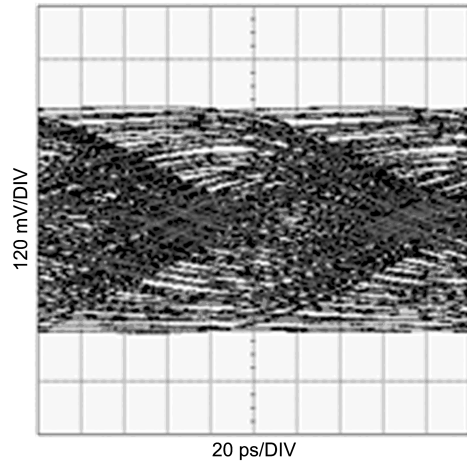

30029420

FIGURE 14. Unequalized Signal (20in FR4, 10Gbps, PRBS7)

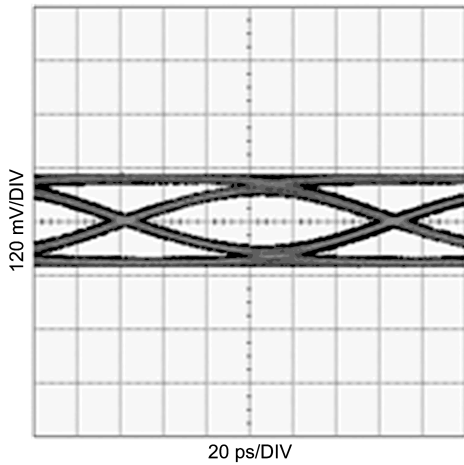

30029418

FIGURE 12. Equalized Signal (20in FR4, 8Gbps, PRBS7)

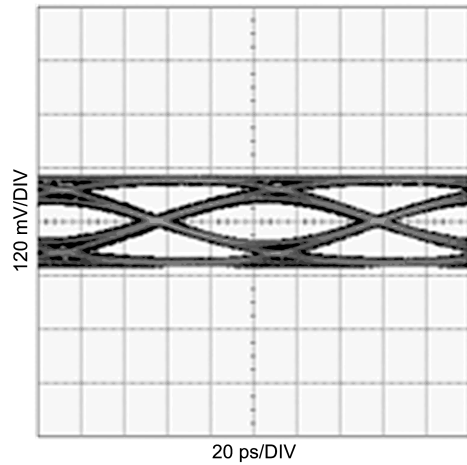

30029421

FIGURE 15. Equalized Signal (20in FR4, 10Gbps, PRBS7)

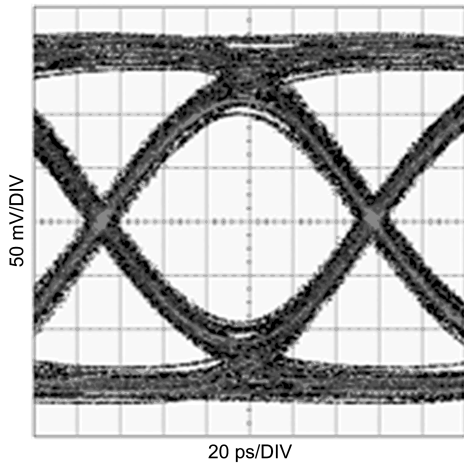

30029419

FIGURE 13. Equalized Signal (Zoom) (20in FR4, 8Gbps, PRBS7)

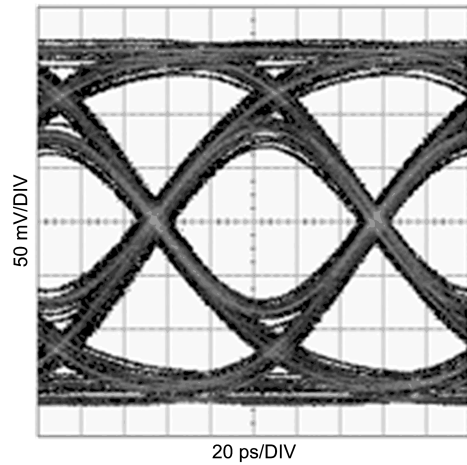

30029422

FIGURE 16. Equalized Signal (Zoom) (20in FR4, 10Gbps, PRBS7)

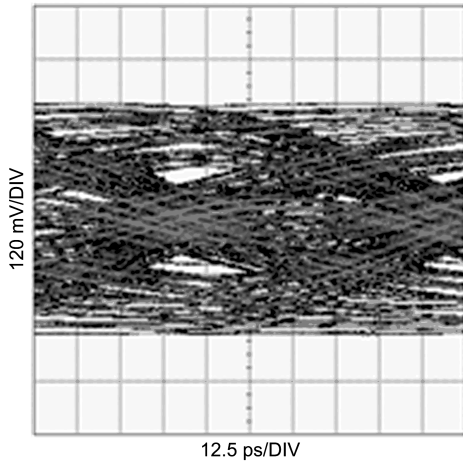

30029423

**FIGURE 17. Unequalized Signal (14in FR4, 12.5Gbps, PRBS7)**

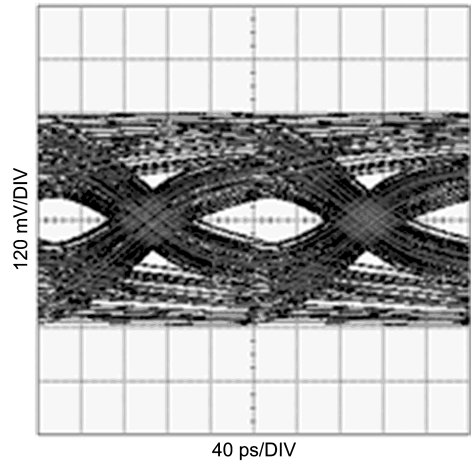

30029426

**FIGURE 20. Unequalized Signal (5m 26AWG Twin-AX Cable, 5Gbps, PRBS7)**

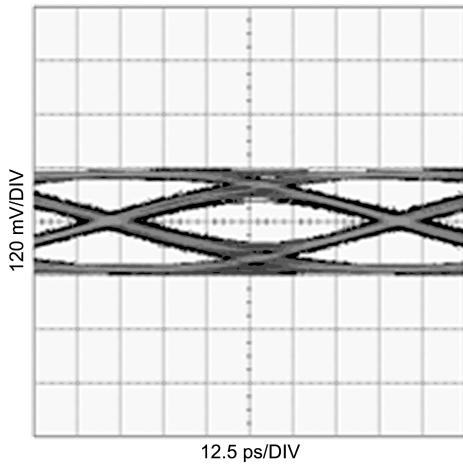

30029424

**FIGURE 18. Equalized Signal (14in FR4, 12.5Gbps, PRBS7)**

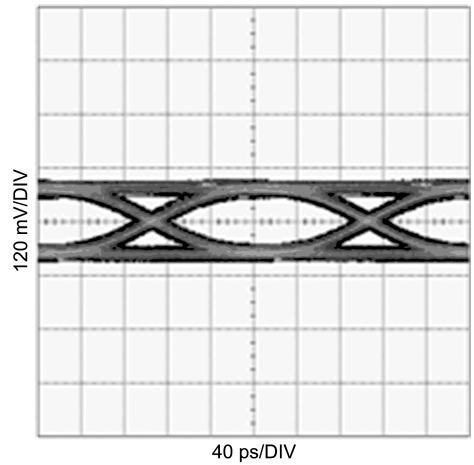

30029427

**FIGURE 21. Equalized Signal (5m 26AWG Twin-AX Cable, 5Gbps, PRBS7)**

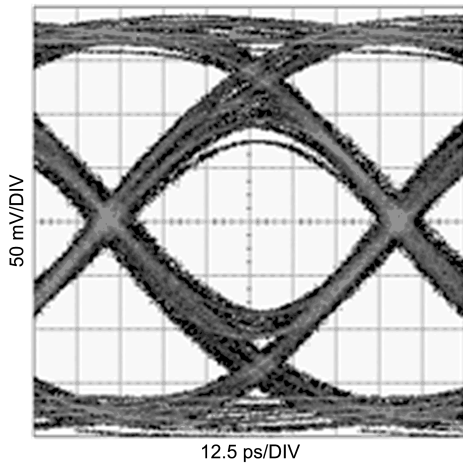

30029425

**FIGURE 19. Equalized Signal (Zoom) (14in FR4, 12.5Gbps, PRBS7)**

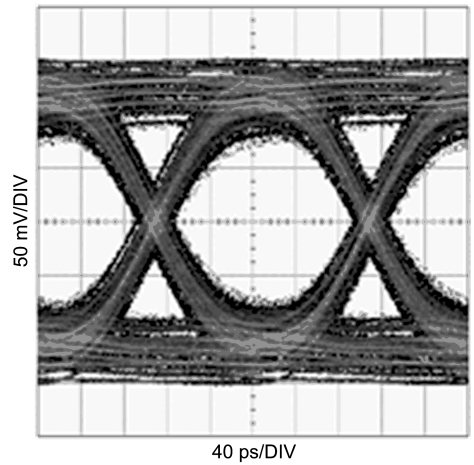

30029428

**FIGURE 22. Equalized Signal (Zoom) (5m 26AWG Twin-AX Cable, 5Gbps, PRBS7)**

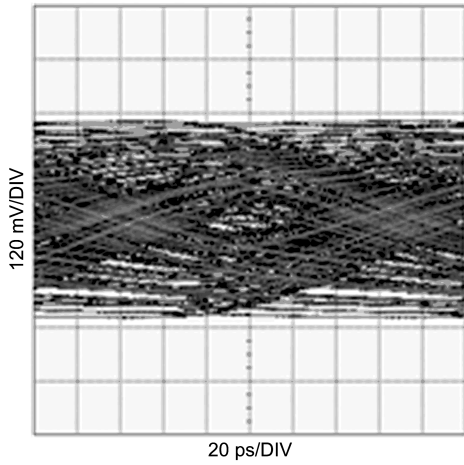

30029429

FIGURE 23. Unequalized Signal (5m 26AWG Twin-AX Cable, 8Gbps, PRBS7)

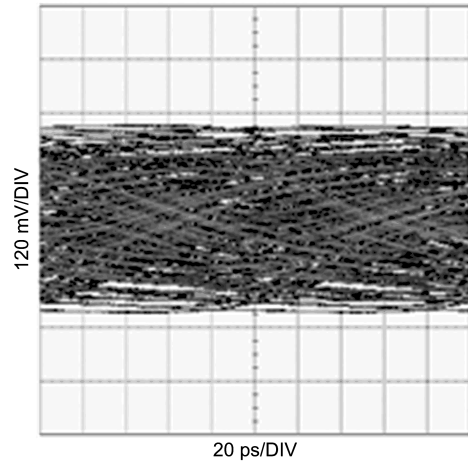

30029432

FIGURE 26. Unequalized Signal (5m 26AWG Twin-AX Cable, 10Gbps, PRBS7)

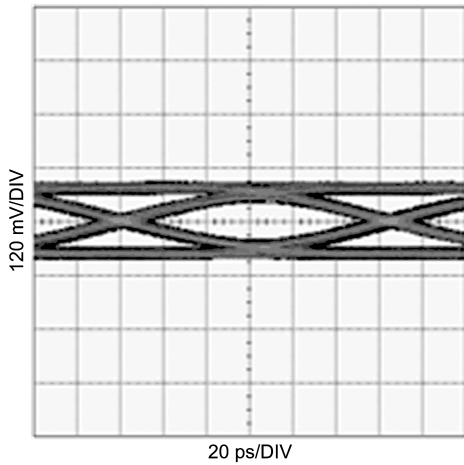

30029430

FIGURE 24. Equalized Signal (5m 26AWG Twin-AX Cable, 8Gbps, PRBS7)

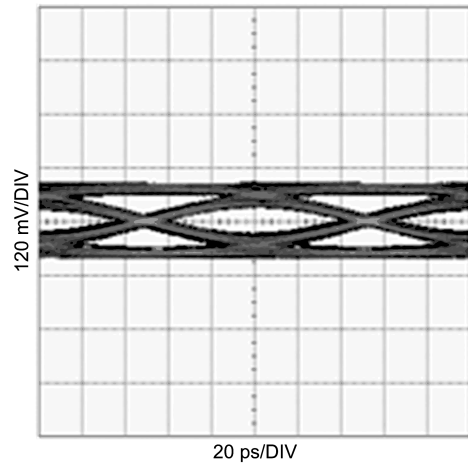

30029433

FIGURE 27. Equalized Signal (5m 26AWG Twin-AX Cable, 10Gbps, PRBS7)

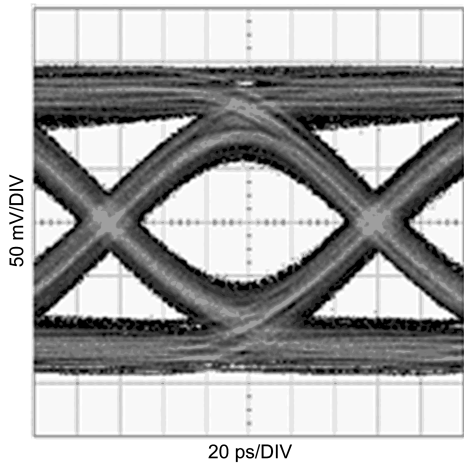

30029431

FIGURE 25. Equalized Signal (Zoom) (5m 26AWG Twin-AX Cable, 8Gbps, PRBS7)

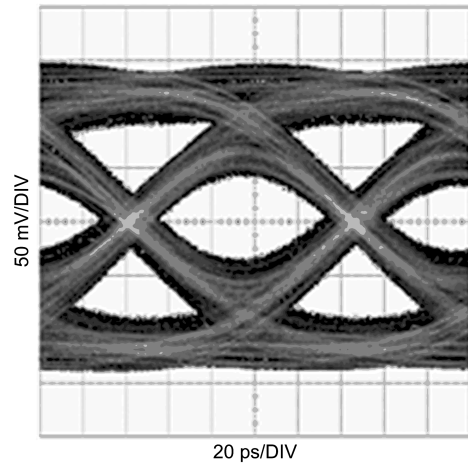

30029434

FIGURE 28. Equalized Signal (Zoom) (5m 26AWG Twin-AX Cable, 10Gbps, PRBS7)

**Physical Dimensions** inches (millimeters) unless otherwise noted

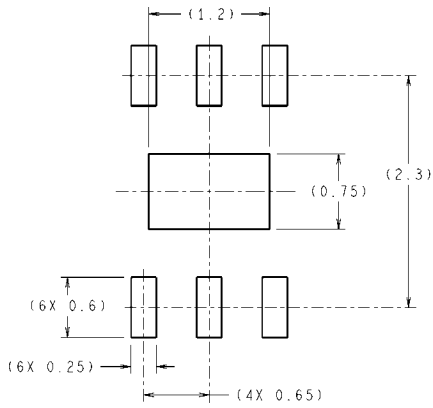

**RECOMMENDED LAND PATTERN**

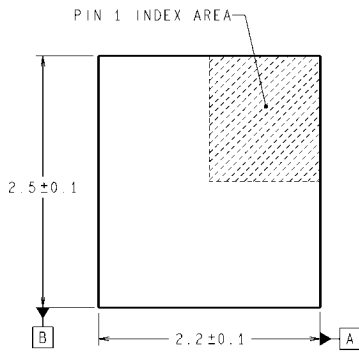

**DIMENSIONS ARE IN MILLIMETERS**  
DIMENSIONS IN ( ) FOR REFERENCE ONLY

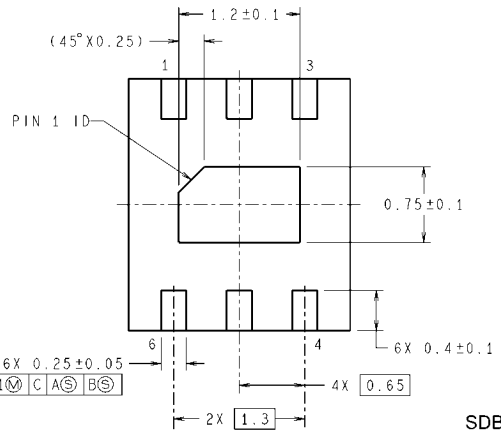
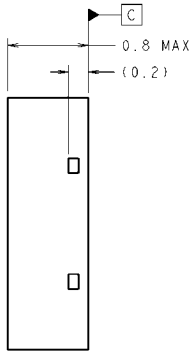
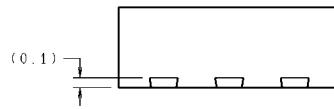

6X 0.25 ± 0.05  
⊕ 0.1 (M) C (A) (S) (B) (S)

SDB06A (Rev A)

**Order Number DS80EP100**  
**See NS Package SDB06A**

# Notes

DS80EP100

## Notes

THE CONTENTS OF THIS DOCUMENT ARE PROVIDED IN CONNECTION WITH NATIONAL SEMICONDUCTOR CORPORATION ("NATIONAL") PRODUCTS. NATIONAL MAKES NO REPRESENTATIONS OR WARRANTIES WITH RESPECT TO THE ACCURACY OR COMPLETENESS OF THE CONTENTS OF THIS PUBLICATION AND RESERVES THE RIGHT TO MAKE CHANGES TO SPECIFICATIONS AND PRODUCT DESCRIPTIONS AT ANY TIME WITHOUT NOTICE. NO LICENSE, WHETHER EXPRESS, IMPLIED, ARISING BY ESTOPPEL OR OTHERWISE, TO ANY INTELLECTUAL PROPERTY RIGHTS IS GRANTED BY THIS DOCUMENT.

TESTING AND OTHER QUALITY CONTROLS ARE USED TO THE EXTENT NATIONAL DEEMS NECESSARY TO SUPPORT NATIONAL'S PRODUCT WARRANTY. EXCEPT WHERE MANDATED BY GOVERNMENT REQUIREMENTS, TESTING OF ALL PARAMETERS OF EACH PRODUCT IS NOT NECESSARILY PERFORMED. NATIONAL ASSUMES NO LIABILITY FOR APPLICATIONS ASSISTANCE OR BUYER PRODUCT DESIGN. BUYERS ARE RESPONSIBLE FOR THEIR PRODUCTS AND APPLICATIONS USING NATIONAL COMPONENTS. PRIOR TO USING OR DISTRIBUTING ANY PRODUCTS THAT INCLUDE NATIONAL COMPONENTS, BUYERS SHOULD PROVIDE ADEQUATE DESIGN, TESTING AND OPERATING SAFEGUARDS.

EXCEPT AS PROVIDED IN NATIONAL'S TERMS AND CONDITIONS OF SALE FOR SUCH PRODUCTS, NATIONAL ASSUMES NO LIABILITY WHATSOEVER, AND NATIONAL DISCLAIMS ANY EXPRESS OR IMPLIED WARRANTY RELATING TO THE SALE AND/OR USE OF NATIONAL PRODUCTS INCLUDING LIABILITY OR WARRANTIES RELATING TO FITNESS FOR A PARTICULAR PURPOSE, MERCHANTABILITY, OR INFRINGEMENT OF ANY PATENT, COPYRIGHT OR OTHER INTELLECTUAL PROPERTY RIGHT.

### LIFE SUPPORT POLICY

**NATIONAL'S PRODUCTS ARE NOT AUTHORIZED FOR USE AS CRITICAL COMPONENTS IN LIFE SUPPORT DEVICES OR SYSTEMS WITHOUT THE EXPRESS PRIOR WRITTEN APPROVAL OF THE CHIEF EXECUTIVE OFFICER AND GENERAL COUNSEL OF NATIONAL SEMICONDUCTOR CORPORATION.** As used herein:

Life support devices or systems are devices which (a) are intended for surgical implant into the body, or (b) support or sustain life and whose failure to perform when properly used in accordance with instructions for use provided in the labeling can be reasonably expected to result in a significant injury to the user. A critical component is any component in a life support device or system whose failure to perform can be reasonably expected to cause the failure of the life support device or system or to affect its safety or effectiveness.

National Semiconductor and the National Semiconductor logo are registered trademarks of National Semiconductor Corporation. All other brand or product names may be trademarks or registered trademarks of their respective holders.

Copyright© 2007 National Semiconductor Corporation

For the most current product information visit us at [www.national.com](http://www.national.com)



**National Semiconductor  
Americas Customer  
Support Center**  
Email:  
[new.feedback@nsc.com](mailto:new.feedback@nsc.com)  
Tel: 1-800-272-9959

**National Semiconductor Europe  
Customer Support Center**  
Fax: +49 (0) 180-530-85-86  
Email: [europe.support@nsc.com](mailto:europe.support@nsc.com)  
Deutsch Tel: +49 (0) 69 9508 6208  
English Tel: +49 (0) 870 24 0 2171  
Français Tel: +33 (0) 1 41 91 8790

**National Semiconductor Asia  
Pacific Customer Support Center**  
Email: [ap.support@nsc.com](mailto:ap.support@nsc.com)

**National Semiconductor Japan  
Customer Support Center**  
Fax: 81-3-5639-7507  
Email: [jpn.feedback@nsc.com](mailto:jpn.feedback@nsc.com)  
Tel: 81-3-5639-7560