

Part Number: **DUR07A2-1**

7mm (0.28") DUAL DIGIT NUMERIC DISPLAY

PRELIMINARY SPEC

Features

- 0.28 INCH DIGIT HEIGHT.
- LOW CURRENT OPERATION.
- EXCELLENT CHARACTER APPEARANCE.
- EASY MOUNTING ON P.C. BOARDS OR SOCKETS.
- I.C. COMPATIBLE.
- TWO DIGIT PACKAGE SIMPLIFIES ALIGNMENTS & ASSEMBLY.
- MECHANICALLY RUGGED.
- STANDARD: GRAY FACE, WHITE SEGMENT.
- RoHS COMPLIANT.

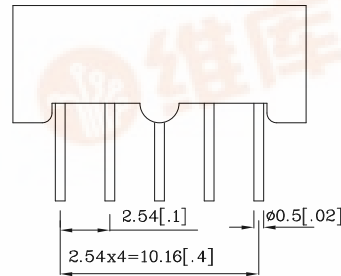
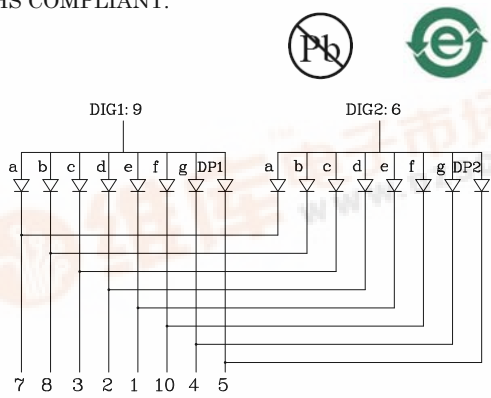
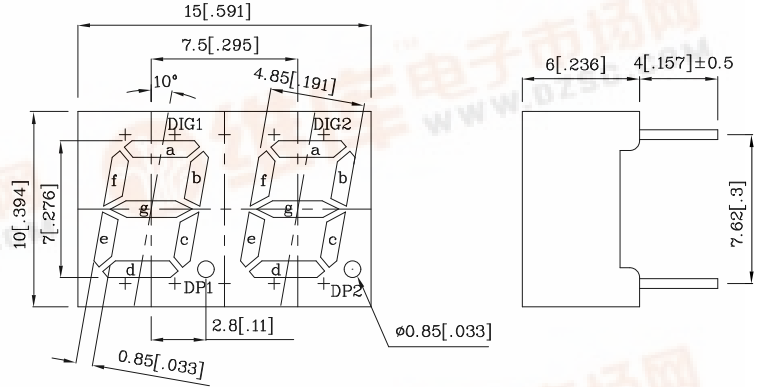

Notes:

1. All dimensions are in millimeters (inches).
2. Tolerance is $\pm 0.25(0.01)$ " unless otherwise noted.
3. Specifications are subject to change without notice.

| Absolute Maximum Ratings (TA=25°C) | | UR (GaAsP/ GaP) | Unit |
|--|-----------------------|-----------------------|------|
| Reverse Voltage | VR | 5 | V |
| Forward Current | IF | 30 | mA |
| Forward Current (Peak) 1/10 Duty Cycle 0.1ms Pulse Width | iFS | 160 | mA |
| Power Dissipation | PT | 75 | mW |
| Operating Temperature | TA | -40 ~ +85 | °C |
| Storage Temperature | Tstg | -40 ~ +85 | |
| Lead Solder Temperature [2mm Below Package Base] | 260°C For 3~5 Seconds | | |

| Operating Characteristics (TA=25°C) | | UR (GaAsP/GaP) | Unit |
|---|-----------------|-------------------|------|
| Forward Voltage (Typ.) (IF=10mA) | VF | 1.9 | V |
| Forward Voltage (Max.) (IF=10mA) | VF | 2.5 | V |
| Reverse Current (Max.) (VR=5V) | IR | 10 | uA |
| Wavelength Of Peak Emission (Typ.) (IF=10mA) | λP | 627 | nm |
| Wavelength Of Dominant Emission (Typ.) (IF=10mA) | λD | 625 | nm |
| Spectral Line Full Width At Half-Maximum (Typ.) (IF=10mA) | $\Delta\lambda$ | 45 | nm |
| Capacitance (Typ.) (VF=0V, f=1MHz) | C | 15 | pF |

| Part Number | Emitting Color | Emitting Material | Luminous Intensity (IF=10mA) ucd | Wavelength nm λP | Description |
|-------------|----------------|-------------------|--|---------------------------------|--------------------------------|
| DUR07A2-1 | Red | GaAsP/GaP | min. 800 typ. 3490 | 627 | Common Anode, Rt. Hand Decimal |



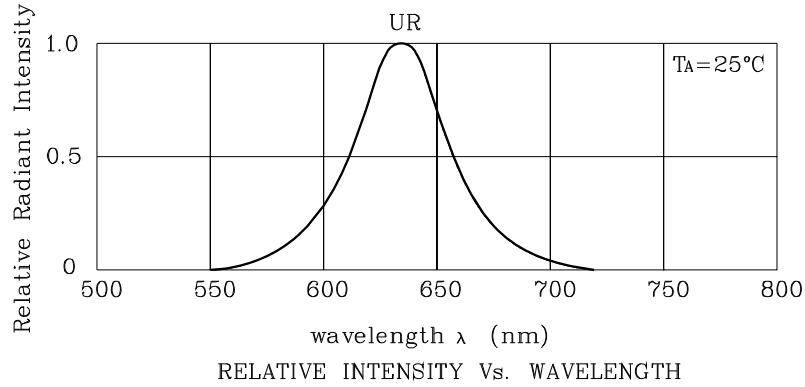

❖ UR

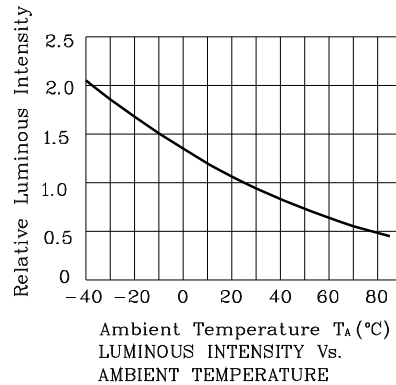
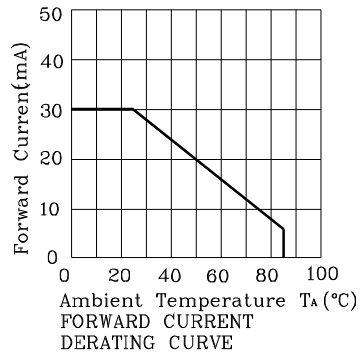
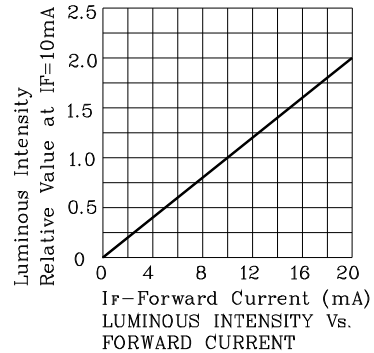
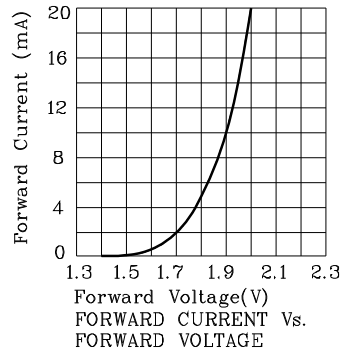

Wave Soldering Profile For Lead-free Through-hole LED.

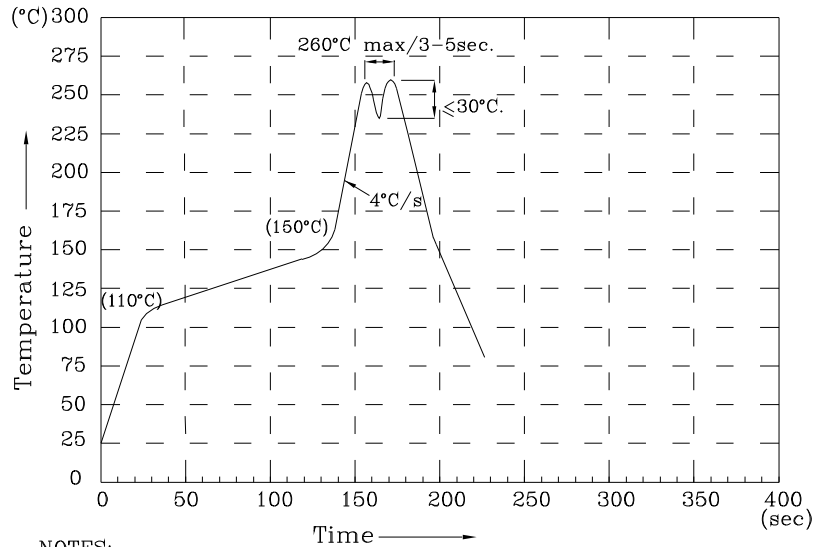

NOTES:

1. Recommend the wave temperature 245°C~260°C. The maximum soldering temperature should be less than 260°C.
2. Do not apply stress on epoxy resins when temperature is over 85 degree°C.
3. The soldering profile apply to the lead free soldering (Sn/Cu/Ag alloy).
4. No more than once.

Remarks:

If special sorting is required (e.g. binning based on forward voltage, Luminous intensity / luminous flux, or wavelength), the typical accuracy of the sorting process is as follows:

1. Wavelength: +/-1nm
2. Luminous intensity / luminous flux: +/-15%
3. Forward Voltage: +/-0.1V

Note: Accuracy may depend on the sorting parameters.

PACKING & LABEL SPECIFICATIONS

DUR07A2-1

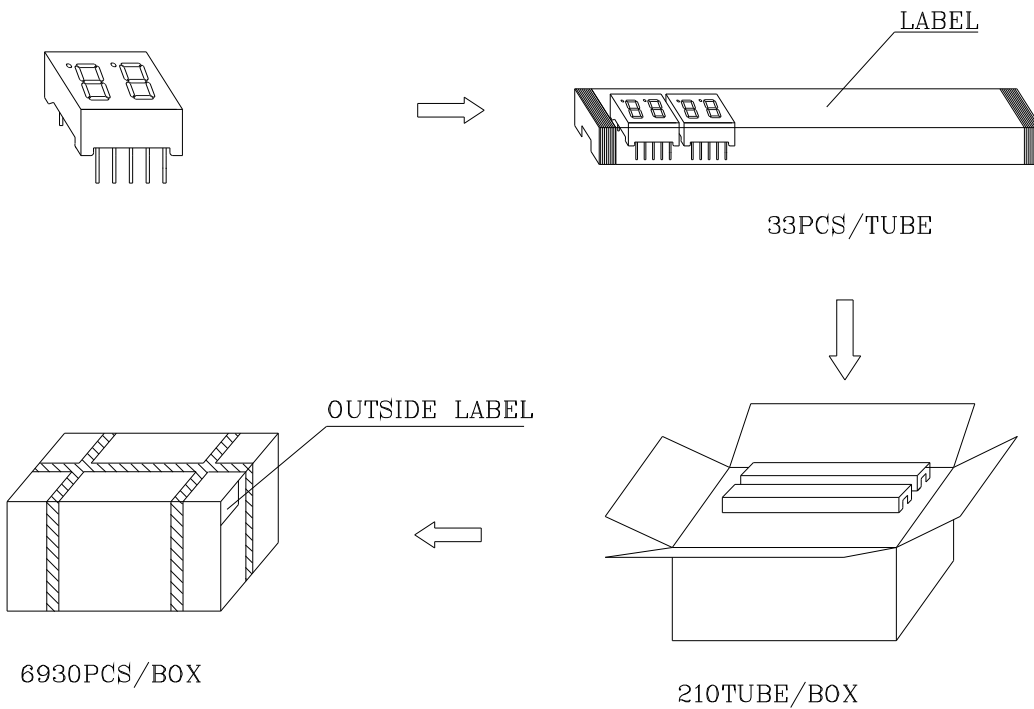

Inside LABEL Paste On The IC-tube

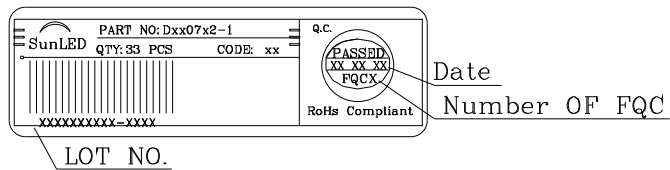

Outside LABEL Paste On The Box

