



STD1802T4-A

Low voltage fast-switching NPN power transistor

Features

- This device is qualified for automotive application
- Very low collector to emitter saturation voltage
- High current gain characteristic
- Fast-switching speed
- Surface-mounting DPAK (TO-252) power package in tape & reel (suffix "T4")

Description

The device is manufactured in Planar technology with "Base Island" layout. The resulting transistor shows exceptional high gain performance coupled with very low saturation voltage.

Applications

- CCFL drivers
- Voltage regulators
- Relay drivers
- High efficiency, low voltage, switching applications

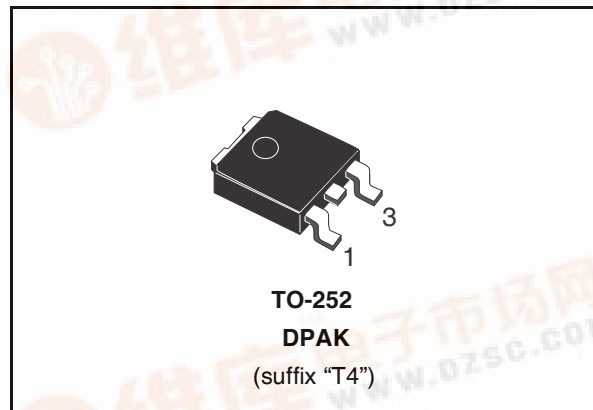

Figure 1. Internal schematic diagram

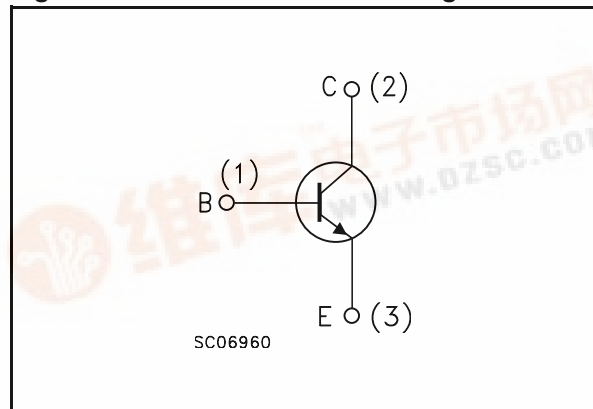

Table 1. Device summary

Order code	Marking	Package	Packaging
STD1802T4-A	D1802	DPAK	Tape & reel



1 Electrical ratings

Table 2. Absolute maximum rating

Symbol	Parameter	Value	Unit
V_{CBO}	Collector-base voltage ($I_E = 0$)	80	V
V_{CEO}	Collector-emitter voltage ($I_B = 0$)	60	V
V_{EBO}	Emitter-base voltage ($I_C = 0$)	6	V
I_C	Collector current	3	A
I_{CM}	Collector peak current ($t_P < 5\text{ms}$)	6	A
I_B	Base current	1	A
P_{tot}	Total dissipation at $T_C \leq 25^\circ\text{C}$	15	W
T_{stg}	Storage temperature	-65 to 150	$^\circ\text{C}$
T_J	Max. operating junction temperature	150	$^\circ\text{C}$

Table 3. Thermal data

Symbol	Parameter	Value	Unit
$R_{thj-case}$	Thermal resistance junction-case max	8.33	$^\circ\text{C/W}$

2 Electrical characteristics

($T_{\text{case}} = 25^{\circ}\text{C}$ unless otherwise specified)

Table 4. Electrical characteristics

Symbol	Parameter	Test Conditions	Min.	Typ.	Max.	Unit
I_{CBO}	Collector cut-off current ($I_{\text{E}} = 0$)	$V_{\text{CB}} = 40\text{V}$			0.1	μA
I_{EBO}	Emitter cut-off current ($I_{\text{C}} = 0$)	$V_{\text{EB}} = 4\text{V}$			0.1	μA
$V_{(\text{BR})\text{CBO}}$	Collector-base breakdown voltage ($I_{\text{E}} = 0$)	$I_{\text{C}} = 100\mu\text{A}$	80			V
$V_{(\text{BR})\text{CEO}}$	Collector-emitter breakdown voltage ($I_{\text{B}} = 0$)	$I_{\text{C}} = 1\text{mA}$	60			V
$V_{(\text{BR})\text{EBO}}$	Emitter-base breakdown voltage ($I_{\text{C}} = 0$)	$I_{\text{E}} = 100\mu\text{A}$	6			V
$V_{\text{CE(sat)}}^{(1)}$	Collector-emitter saturation voltage	$I_{\text{C}} = 2\text{A}$ $I_{\text{B}} = 100\text{mA}$ $I_{\text{C}} = 3\text{A}$ $I_{\text{B}} = 150\text{mA}$		150 200	300 400	mV mV
$V_{\text{BE(sat)}}^{(1)}$	Base-emitter saturation voltage	$I_{\text{C}} = 2\text{A}$ $I_{\text{B}} = 100\text{mA}$		0.9	1.2	V
$h_{\text{FE}}^{(1)}$	DC current gain	$I_{\text{C}} = 100\text{mA}$ $V_{\text{CE}} = 2\text{V}$ $I_{\text{C}} = 3\text{A}$ $V_{\text{CE}} = 2\text{V}$	200 100		400	
f_{T}	Transition frequency	$V_{\text{CE}} = 10\text{V}$ $I_{\text{C}} = 50\text{mA}$		150		MHz
C_{CBO}	Collector-base capacitance	$V_{\text{CB}} = 10\text{V}$ $f = 1\text{MHz}$		50		pF
t_{ON} t_{s} t_{f}	Resistive load Turn-on time Storage time Fall time	$I_{\text{C}} = 1\text{A}$ $V_{\text{CC}} = 30\text{V}$ $I_{\text{B1}} = -I_{\text{B2}} = 0.1\text{A}$		50 1.35 120		ns μs ns

Note (1) Pulsed duration = 300 μs , duty cycle $\leq 1.5\%$

2.1 Electrical characteristics (curves)

Figure 2. Derating curve

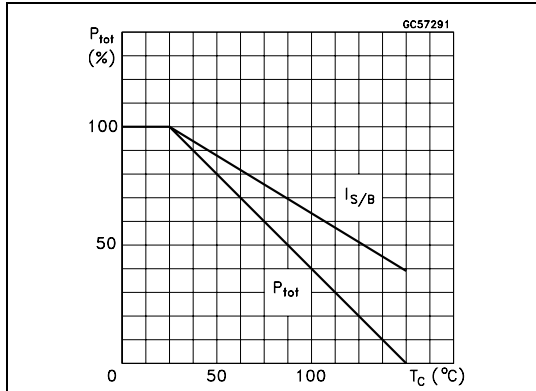

Figure 3. DC current gain

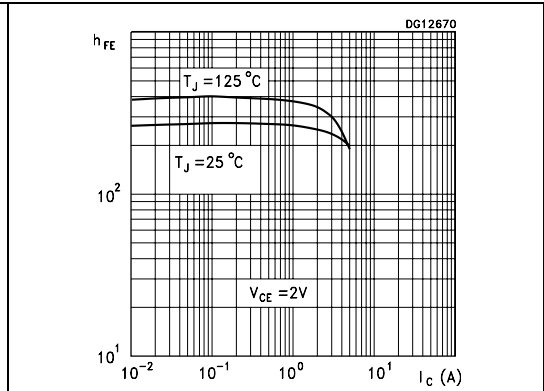

Figure 4. Collector-emitter saturation voltage

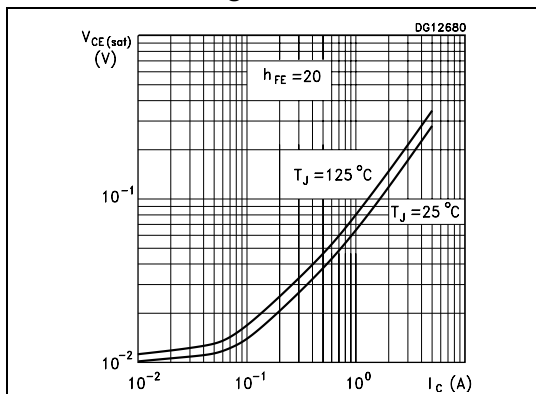

Figure 5. Collector-emitter saturation voltage

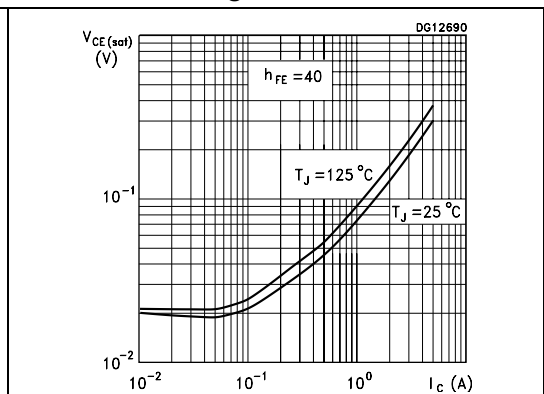

Figure 6. Base-emitter saturation voltage

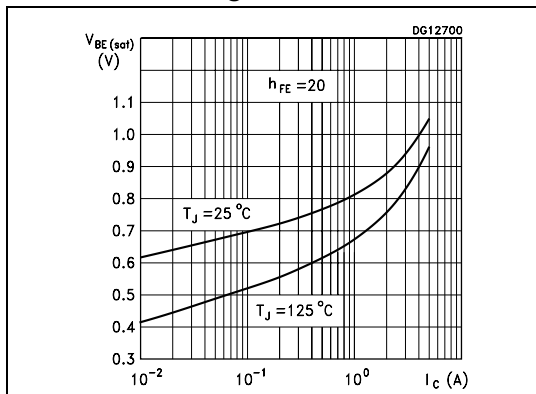

Figure 7. Base-emitter on voltage

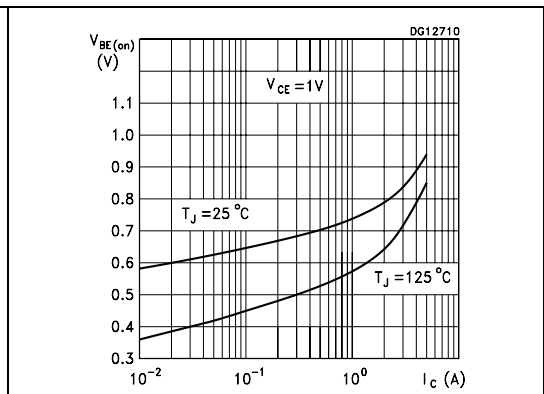

Figure 8. Switching times resistive load

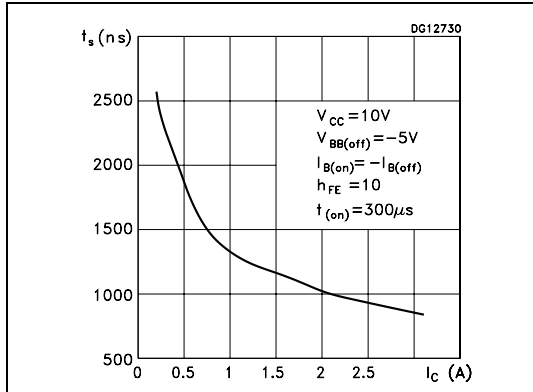

Figure 9. Switching times resistive load

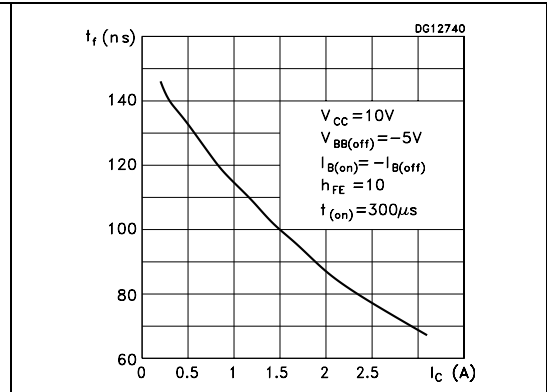

Figure 10. Switching times resistive load

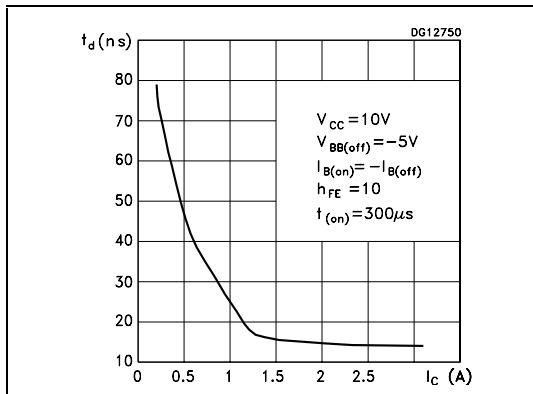

Figure 11. Switching times inductive load

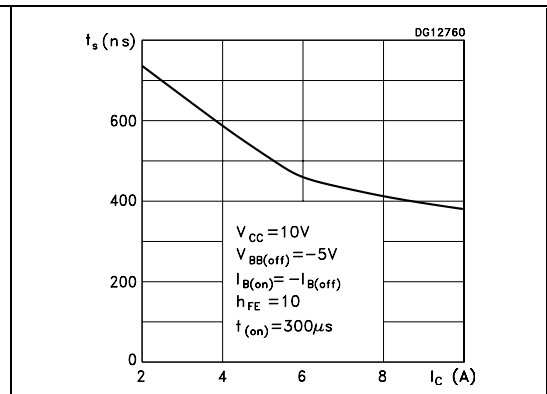
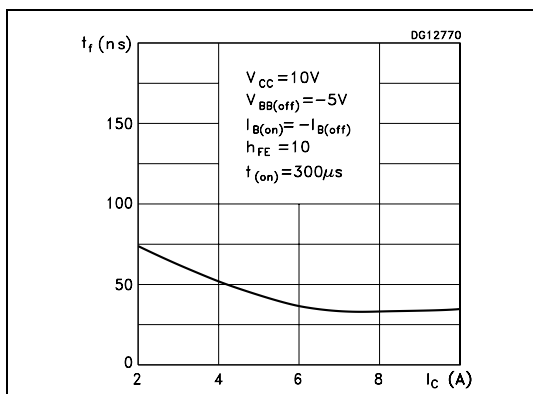
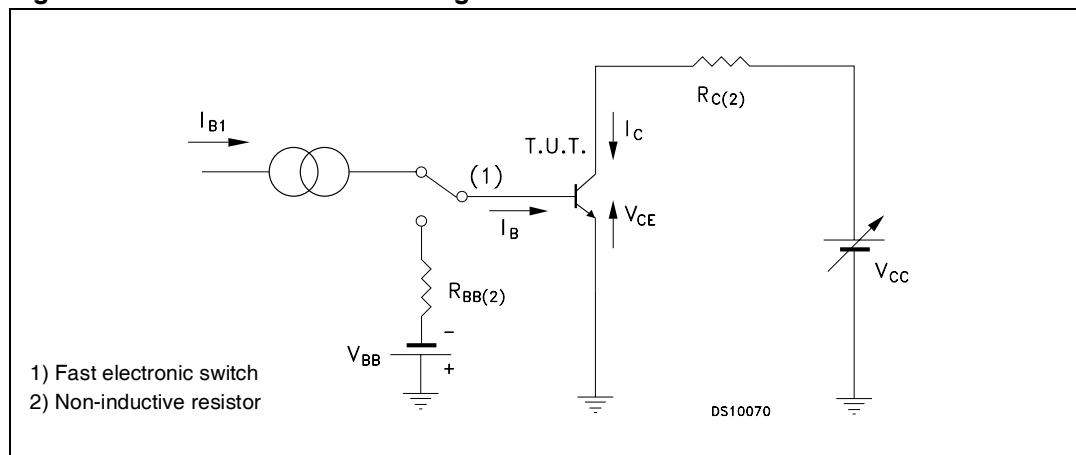

Figure 12. Switching times resistive load



2.2 Test circuits

Figure 13. Resistive load switching test circuit



3 Package mechanical data

In order to meet environmental requirements, ST offers these devices in ECOPACK® packages. These packages have a Lead-free second level interconnect. The category of second level interconnect is marked on the package and on the inner box label, in compliance with JEDEC Standard JESD97. The maximum ratings related to soldering conditions are also marked on the inner box label. ECOPACK is an ST trademark. ECOPACK specifications are available at: www.st.com

TO-252 (DPAK) MECHANICAL DATA

DIM.	mm			inch		
	MIN.	TYP.	MAX.	MIN.	TYP.	MAX.
A	2.20		2.40	0.087		0.094
A1	0.90		1.10	0.035		0.043
A2	0.03		0.23	0.001		0.009
B	0.64		0.90	0.025		0.035
B2	5.20		5.40	0.204		0.213
C	0.45		0.60	0.018		0.024
C2	0.48		0.60	0.019		0.024
D	6.00		6.20	0.236		0.244
E	6.40		6.60	0.252		0.260
G	4.40		4.60	0.173		0.181
H	9.35		10.10	0.368		0.398
L2		0.8			0.031	
L4	0.60		1.00	0.024		0.039
V2	0°		8°	0°		0°

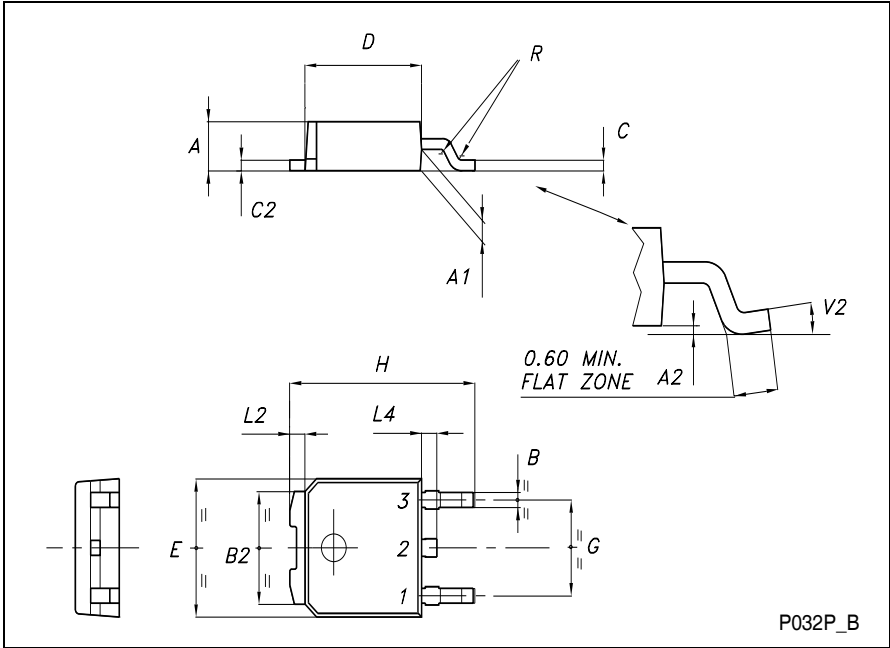

4 Revision history

Table 5. Revision history

Date	Revision	Changes
28-Jun-2007	1	Initial release.

Please Read Carefully:

Information in this document is provided solely in connection with ST products. STMicroelectronics NV and its subsidiaries ("ST") reserve the right to make changes, corrections, modifications or improvements, to this document, and the products and services described herein at any time, without notice.

All ST products are sold pursuant to ST's terms and conditions of sale.

Purchasers are solely responsible for the choice, selection and use of the ST products and services described herein, and ST assumes no liability whatsoever relating to the choice, selection or use of the ST products and services described herein.

No license, express or implied, by estoppel or otherwise, to any intellectual property rights is granted under this document. If any part of this document refers to any third party products or services it shall not be deemed a license grant by ST for the use of such third party products or services, or any intellectual property contained therein or considered as a warranty covering the use in any manner whatsoever of such third party products or services or any intellectual property contained therein.

UNLESS OTHERWISE SET FORTH IN ST'S TERMS AND CONDITIONS OF SALE ST DISCLAIMS ANY EXPRESS OR IMPLIED WARRANTY WITH RESPECT TO THE USE AND/OR SALE OF ST PRODUCTS INCLUDING WITHOUT LIMITATION IMPLIED WARRANTIES OF MERCHANTABILITY, FITNESS FOR A PARTICULAR PURPOSE (AND THEIR EQUIVALENTS UNDER THE LAWS OF ANY JURISDICTION), OR INFRINGEMENT OF ANY PATENT, COPYRIGHT OR OTHER INTELLECTUAL PROPERTY RIGHT.

UNLESS EXPRESSLY APPROVED IN WRITING BY AN AUTHORIZED REPRESENTATIVE OF ST, ST PRODUCTS ARE NOT RECOMMENDED, AUTHORIZED OR WARRANTED FOR USE IN MILITARY, AIR CRAFT, SPACE, LIFE SAVING, OR LIFE SUSTAINING APPLICATIONS, NOR IN PRODUCTS OR SYSTEMS, WHERE FAILURE OR MALFUNCTION MAY RESULT IN PERSONAL INJURY, DEATH, OR SEVERE PROPERTY OR ENVIRONMENTAL DAMAGE. ST PRODUCTS WHICH ARE NOT SPECIFIED AS "AUTOMOTIVE GRADE" MAY ONLY BE USED IN AUTOMOTIVE APPLICATIONS AT USER'S OWN RISK.

Resale of ST products with provisions different from the statements and/or technical features set forth in this document shall immediately void any warranty granted by ST for the ST product or service described herein and shall not create or extend in any manner whatsoever, any liability of ST.

ST and the ST logo are trademarks or registered trademarks of ST in various countries.

Information in this document supersedes and replaces all information previously supplied.

The ST logo is a registered trademark of STMicroelectronics. All other names are the property of their respective owners.

© 2007 STMicroelectronics - All rights reserved

STMicroelectronics group of companies

Australia - Belgium - Brazil - Canada - China - Czech Republic - Finland - France - Germany - Hong Kong - India - Israel - Italy - Japan - Malaysia - Malta - Morocco - Singapore - Spain - Sweden - Switzerland - United Kingdom - United States of America

www.st.com