

# OMRON EE-SH3 Series

# Photomicrosensor (Transmissive)

## ■ Dimensions

**Note:** All units are in millimeters unless otherwise indicated.

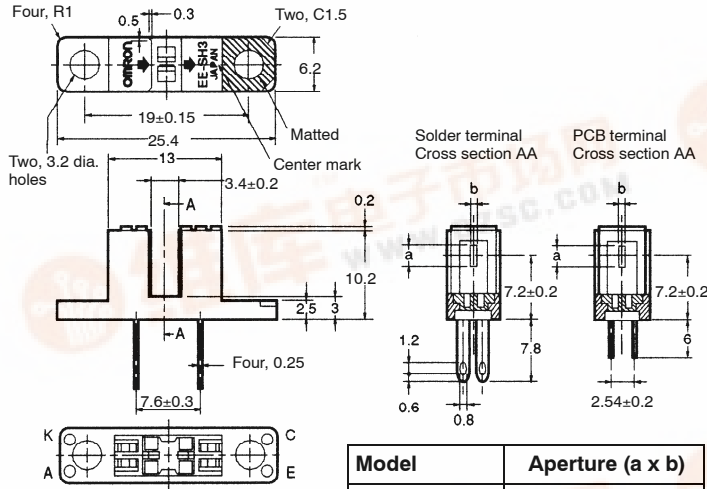

Model	Aperture (a x b)
EE-SH3(-B)	2.1 x 0.5
EE-SH3-C(S)	2.1 x 1.0
EE-SH3-D(S)	2.1 x 0.2
EE-SH3-G(S)	0.5 x 2.1

### Internal Circuit

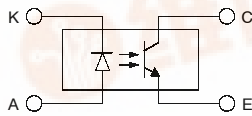

Unless otherwise specified, the tolerances are as shown below.

Dimensions	Tolerance
3 mm max.	±0.2
3 < mm ≤ 6	±0.24
6 < mm ≤ 10	±0.29
10 < mm ≤ 18	±0.35
18 < mm ≤ 30	±0.42

Terminal No.	Name
A	Anode
K	Cathode
C	Collector
E	Emitter

## ■ Features

- All models have 3.4 mm wide slot.
- Solder terminal models:  
EE-SH3/-SH3-CS/-SH3-DS/-SH3-GS
- PCB terminal models:  
EE-SH3-B/-SH3-C/-SH3-D/-SH3-G

## ■ Absolute Maximum Ratings (Ta = 25°C)

Item	Symbol	Rated value
Emitter	Forward current	$I_F$ 50 mA (see note 1)
	Pulse forward current	$I_{FP}$ 1 A (see note 2)
	Reverse voltage	$V_R$ 4 V
Detector	Collector-Emitter voltage	$V_{CEO}$ 30 V
	Emitter-Collector voltage	$V_{ECO}$ ---
	Collector current	$I_C$ 20 mA
	Collector dissipation	$P_C$ 100 mW (see note 1)
Ambient temperature	Operating	$T_{opr}$ -25°C to 85°C
	Storage	$T_{stg}$ -30°C to 100°C
Soldering temperature	$T_{sol}$	260°C (see note 3)

- Note:**
- Refer to the temperature rating chart if the ambient temperature exceeds 25°C.
  - The pulse width is 10 μs maximum with a frequency of 100 Hz.
  - Complete soldering within 10 seconds.

## ■ Ordering Information

Description	Part number
Photomicrosensor (Transmissive)	EE-SH3(-B)
	EE-SH3-C(S)
	EE-SH3-D(S)
	EE-SH3-G(S)

## ■ Electrical and Optical Characteristics (Ta = 25°C)

Item	Symbol	Value				Condition
		EE-SH3(-B)	EE-SH3-C(S)	EE-SH3-D(S)	EE-SH3-G(S)	
Emitter	Forward voltage	$V_F$	1.2 V typ., 1.5 V max.			$I_F = 30$ mA
	Reverse current	$I_R$	0.01 μA typ., 10 μA max.			$V_R = 4$ V
	Peak emission wavelength	$\lambda_P$	940 nm typ.			$I_F = 20$ mA
Detector	Light current	$I_L$	0.5 to 14 mA typ.	1 to 28 mA typ.	0.1 mA min.	0.5 to 14 mA $I_F = 20$ mA, $V_{CE} = 10$ V
	Dark current	$I_D$	2 nA typ., 200 nA max.			$V_{CE} = 10$ V, 0 lx
	Leakage current	$I_{LEAK}$	---			---
	Collector-Emitter saturated voltage	$V_{CE(sat)}$	0.1 V typ., 0.4 V max.		---	0.1 V typ., 0.4 V max. $I_F = 20$ mA, $I_L = 0.1$ mA
Peak spectral sensitivity wavelength	$\lambda_P$	850 nm typ.			$V_{CE} = 10$ V	
Rising time	$t_r$	4 μs typ.			$V_{CC} = 5$ V, $R_L = 100$ Ω, $I_L = 5$ mA	
Falling time	$t_f$	4 μs typ.				



■ Engineering Data

**Forward Current vs. Collector Dissipation Temperature Rating**

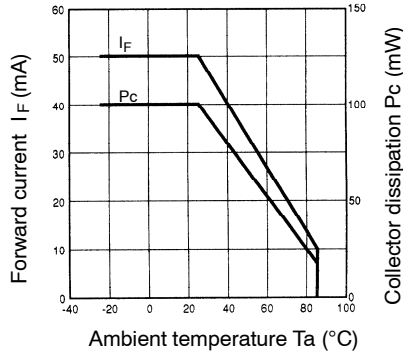

**Forward Current vs. Forward Voltage Characteristics (Typical)**

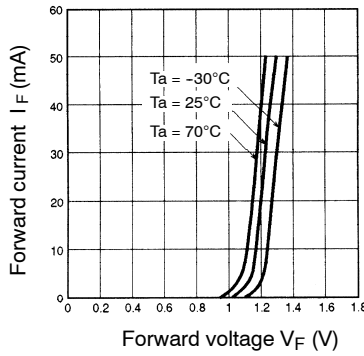

**Light Current vs. Forward Current Characteristics (Typical)**

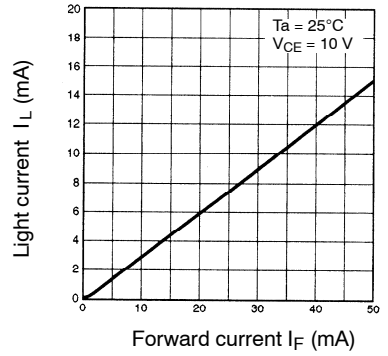

**Light Current vs. Collector-Emitter Voltage Characteristics (EE-SH3(B))**

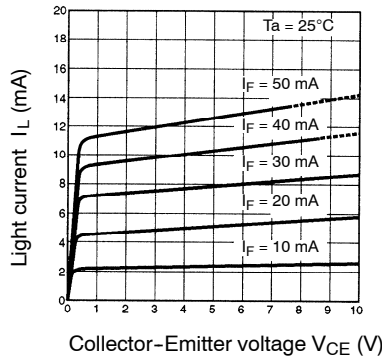

**Relative Light Current vs. Ambient Temperature Characteristics (Typical)**

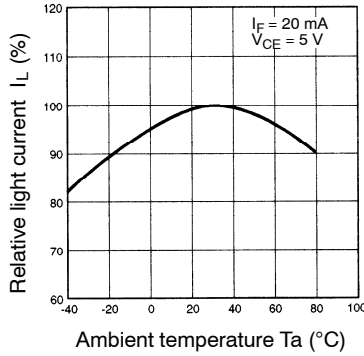

**Dark Current vs. Ambient Temperature Characteristics (Typical)**

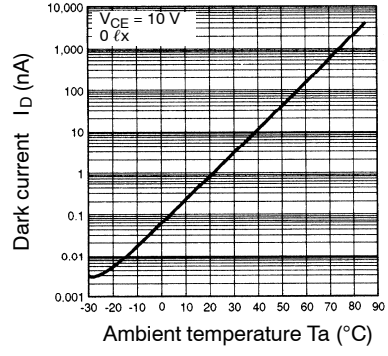

**Response Time vs. Load Resistance Characteristics (Typical)**

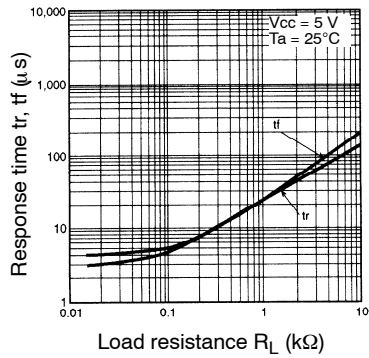

**Sensing Position Characteristics (EE-SH3-D(S))**

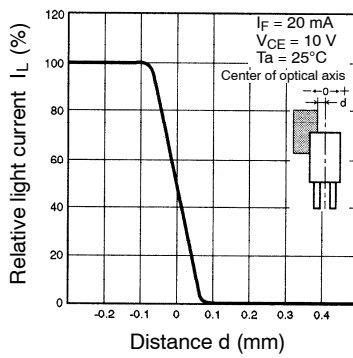

**Sensing Position Characteristics (EE-SH3(B))**

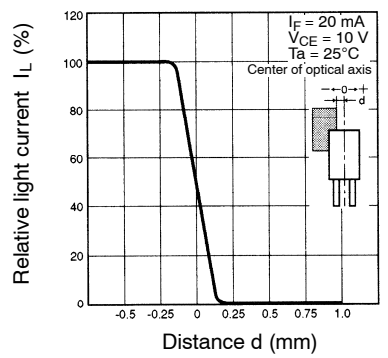

**Sensing Position Characteristics (EE-SH3-G(S))**

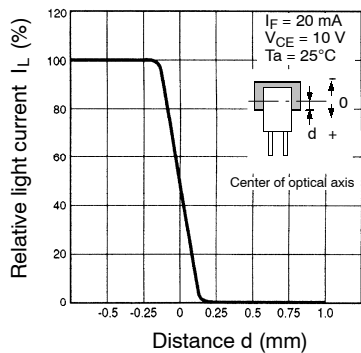

**Sensing Position Characteristics (EE-SH3-C(S))**

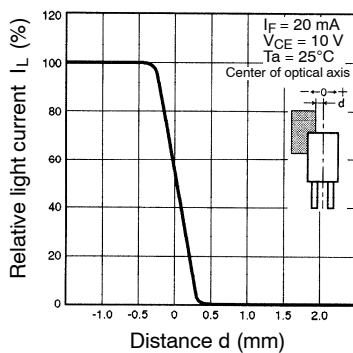

**Response Time Measurement Circuit**

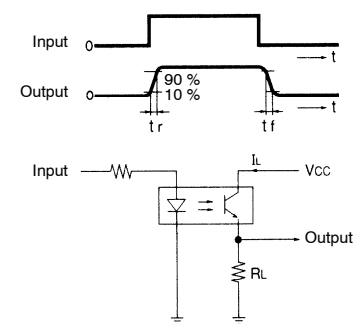

**NOTE: DIMENSIONS SHOWN ARE IN MILLIMETERS. To convert millimeters to inches divide by 25.4.**

---

**OMRON**<sup>®</sup>

**OMRON ELECTRONICS LLC**

One East Commerce Drive  
Schaumburg, IL 60173

**847-882-2288**

**OMRON CANADA, INC.**

885 Milner Avenue  
Toronto, Ontario M1B 5V8

**416-286-6465**

**OMRON ON-LINE**

Global – <http://www.omron.com>

USA – <http://www.omron.com/oei>

Canada – <http://www.omron.com/oci>