

SERIES E G SWITCHES

SLIDE SWITCHES

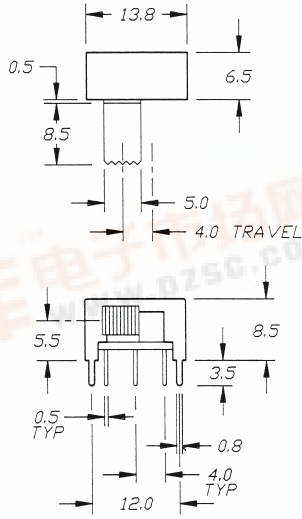

2219



P.C. MOUNTING

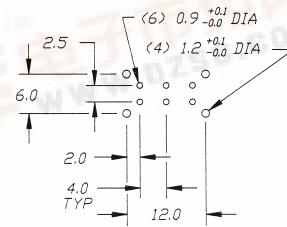

Schematic

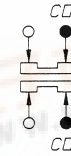

2301

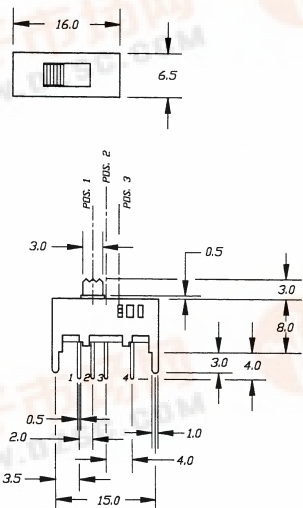

P.C. MOUNTING

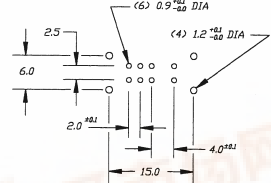

Schematic

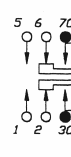

Model No.	L
EG2301	3
EG2301A	6
EG2301B	9
EG2301C	12



2303

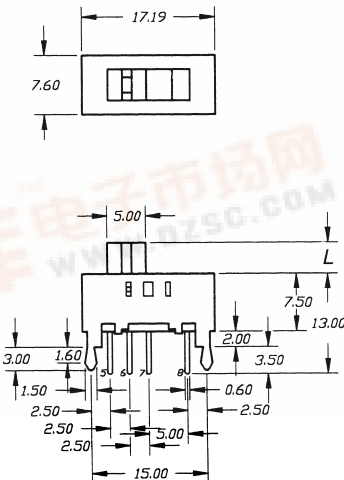

P.C. MOUNTING

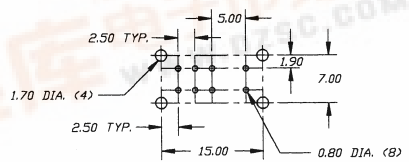

Schematic

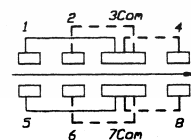

SPECIFICATIONS SUBJECT TO CHANGE WITHOUT NOTICE.



# SERIES E G SWITCHES

## SLIDE SWITCHES



**2305**

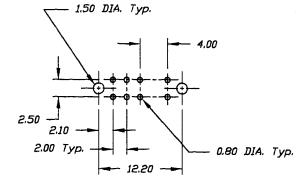
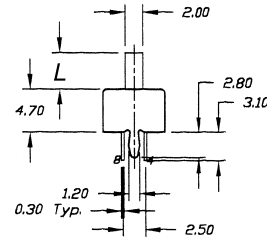
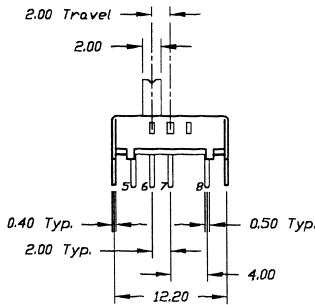
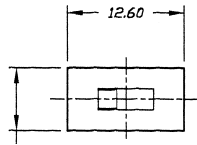

P.C. MOUNTING

Schematic

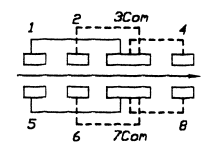

Model No.	L
EG2305	4
EG2305A	2



**2308**

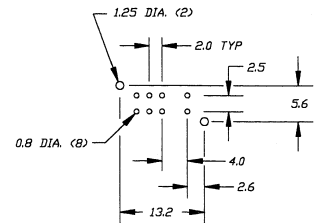
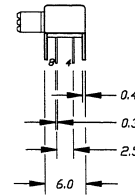
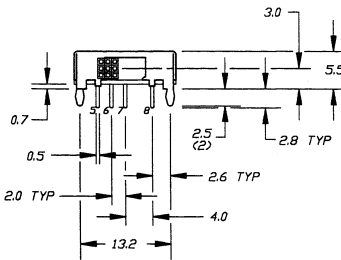
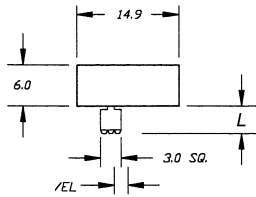

P.C. MOUNTING

Schematic

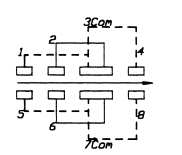

Model No.	L
EG2308	4
EG2308A	6



**2310**

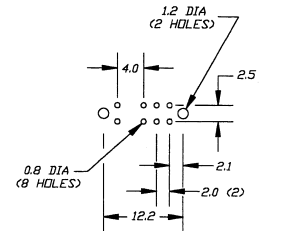
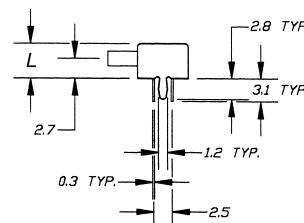
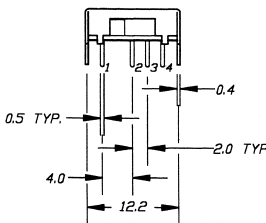
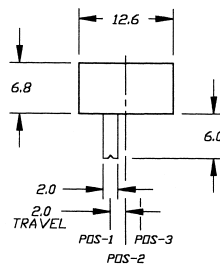

P.C. MOUNTING

Schematic

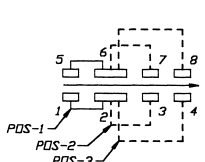

Model No.	L
EG2310	6
EG2310A	4

SPECIFICATIONS SUBJECT TO CHANGE WITHOUT NOTICE.

# SERIES E G SWITCHES

## SLIDE SWITCHES



2315

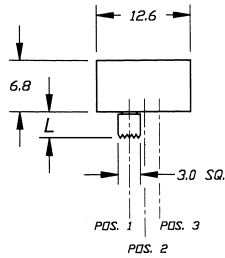

### P.C. MOUNTING

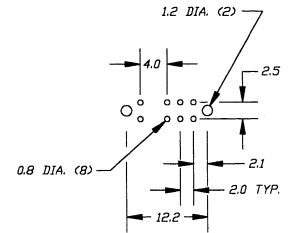

Model No.	L
EG2315	3.5
EG2315A	6

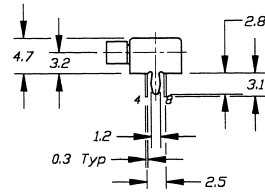
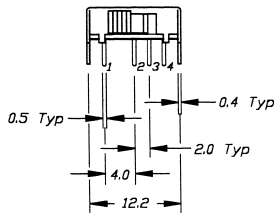

### Schematic

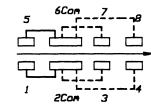

2319

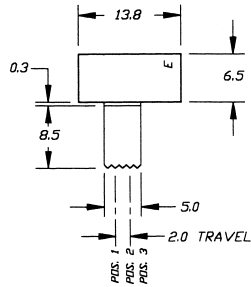

### P.C. MOUNTING

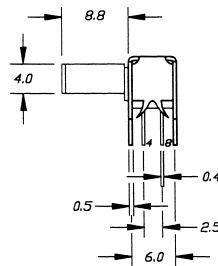
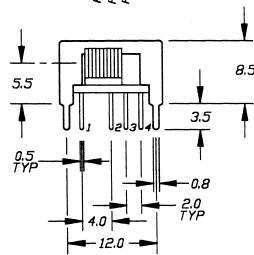
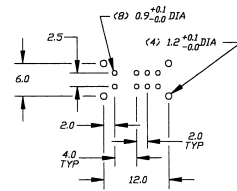

### Schematic

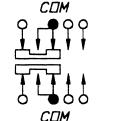

2322

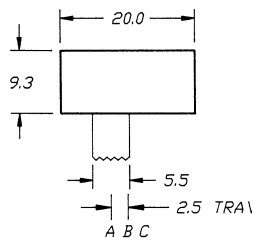

### P.C. MOUNTING

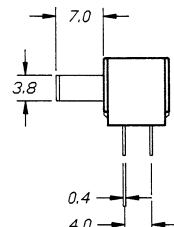
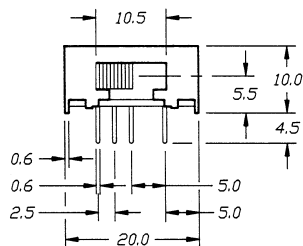
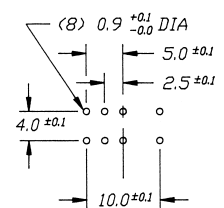

### Schematic

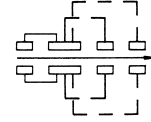

SPECIFICATIONS SUBJECT TO CHANGE WITHOUT NOTICE.

# SERIES E G SWITCHES

## SLIDE SWITCHES



2323

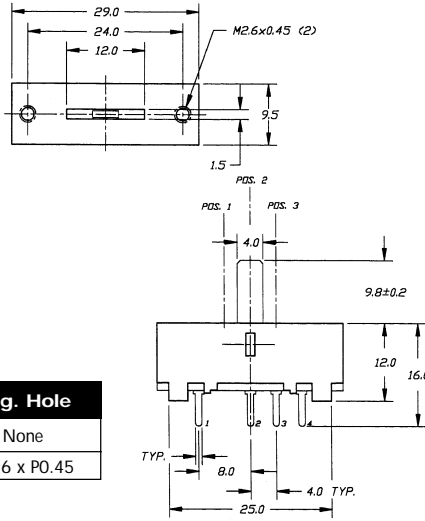

### P.C. MOUNTING

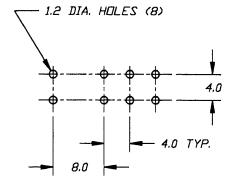

Model No.	Mtg. Hole
EG2323	None
EG2323A	M2.6 x P0.45

### Schematic

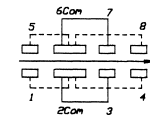

2324

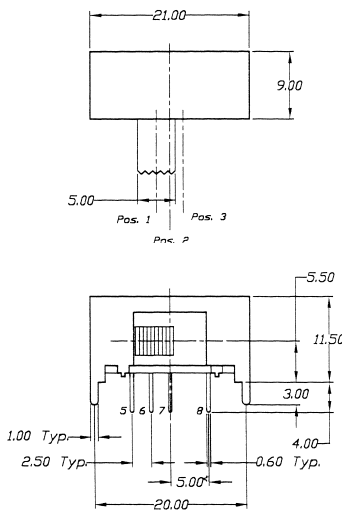

### P.C. MOUNTING

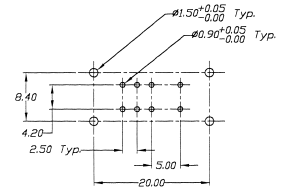

### Schematic

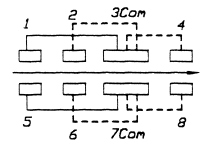

2325

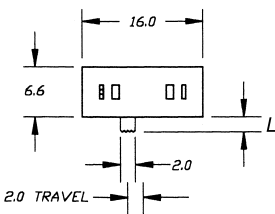

### P.C. MOUNTING

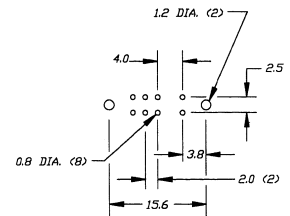

Model No.	L
EG2325	2
EG2325A	6
EG2325B	9

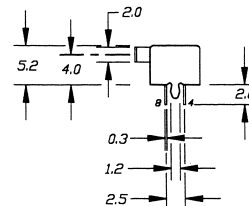
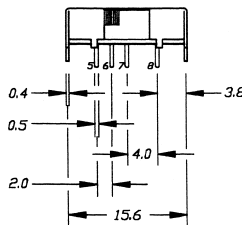

### Schematic

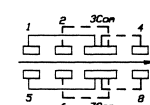

SPECIFICATIONS SUBJECT TO CHANGE WITHOUT NOTICE.

# SERIES E G SWITCHES

## SLIDE SWITCHES

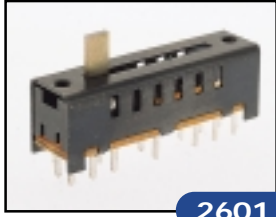

**2601**

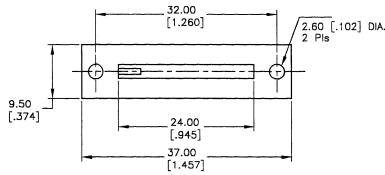

### P.C. MOUNTING

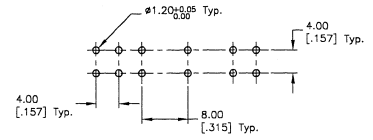

Model No.	L	"A"
EG2601	9.8	None
EG2601A	9.8	M2.6 x P0.45
EG2601B	6.5	M2.6 x P0.45
EG2601C	6.5	None

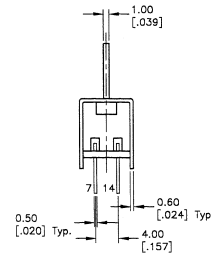
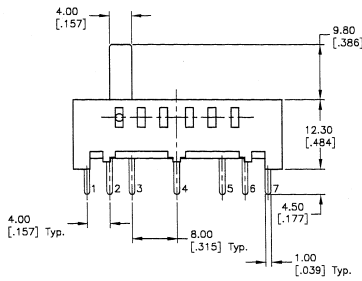

### Schematic

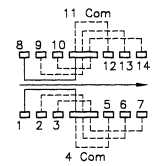

**4208**

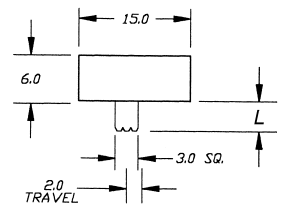

### P.C. MOUNTING

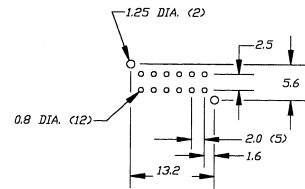

Model No.	L
EG4208	4
EG4208A	6

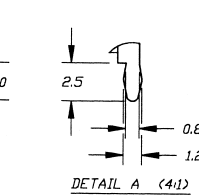
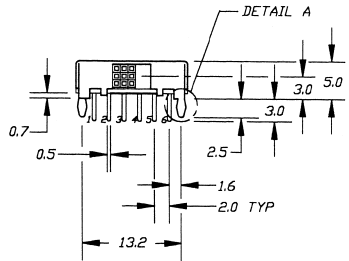

### Schematic

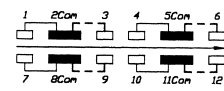

**4311**

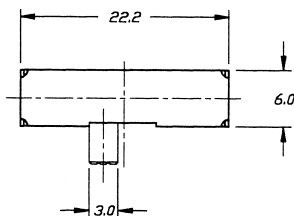

### P.C. MOUNTING

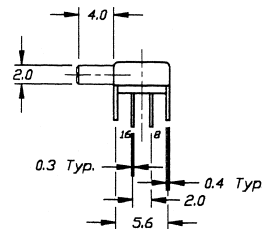
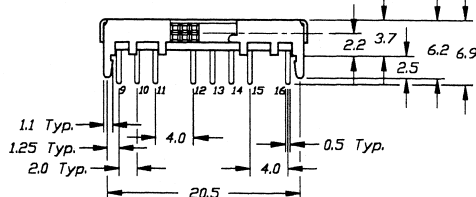
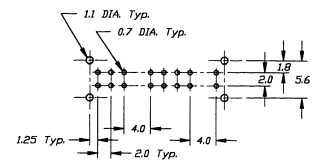

### Schematic

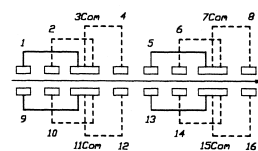

SPECIFICATIONS SUBJECT TO CHANGE WITHOUT NOTICE.

# SERIES E G SWITCHES

## SLIDE SWITCHES

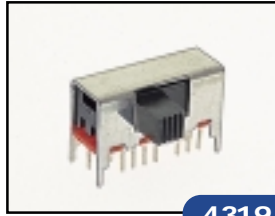

**4319**

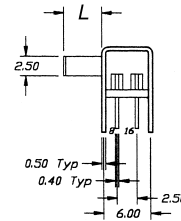
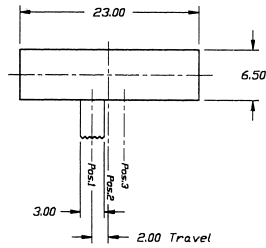

### P.C. MOUNTING

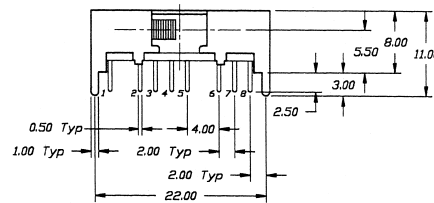
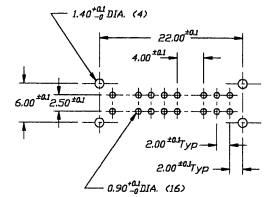

Model No.	L
EG4319	5
EG4319A	6

### Schematic

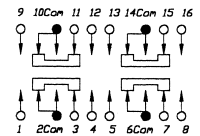

**6201**

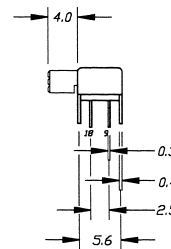
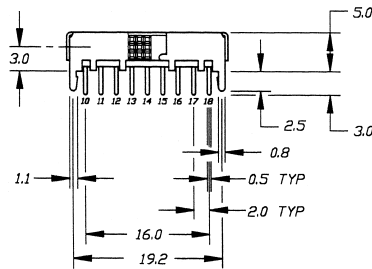
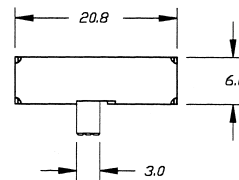

### P.C. MOUNTING

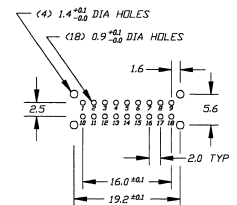

### Schematic

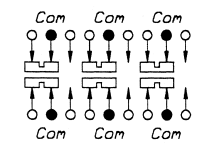

SPECIFICATIONS SUBJECT TO CHANGE WITHOUT NOTICE.