

**élantec**

HIGH PERFORMANCE ANALOG INTEGRATED CIRCUITS

**EL2223/EL2223C**

Dual, 500 MHz High Speed, Operational Amplifier

ELANTEC INC

T-79-07-20

EL2223/EL2223C

## Features

- Wide gain bandwidth—500 MHz
- High slew rate—350 V/ $\mu$ s
- High power bandwidth ( $\pm 10 V_{out}$ ) 5.5 MHz
- Large open loop gain 83 dB
- Low power—5 mA/amplifier
- Low input offset—0.5 mV typ.
- Wide supply voltage range  $V_s = \pm 5V$  to  $\pm 15V$
- Output short circuit protected

## Applications

- High performance active filters
- Video and pulse amplifiers
- Local area networks
- Wideband amplifiers
- Replace two HA2540s

## Ordering Information

Part No.	Temp. Range	Package	Outline*
EL2223CJ	0°C to +75°C	CerDIP	MDP0010
EL2223CN	0°C to +75°C	P-DIP	MDP0031
EL2223J	-55°C to +125°C	CerDIP	MDP0010
EL2223J/883B	-55°C to +125°C	CerDIP	MDP0010
EL2223L/883B	-55°C to +125°C	LCC	MDP0007
EL2223CM	0°C to +75°C	SOL	MDP0027

## General Description

The EL2223 monolithic dual operational amplifier is an extension of Elantec's position in high speed analog products. This patented amplifier features 350 V/ $\mu$ s slew rate, a 500 MHz gain bandwidth gain-of-10 stable, along with an excellent speed power relationship. The dual 500 MHz EL2223 consumes only 10 mA, making it ideal for HA2540 type applications. The EL2223 has short-circuit-protected outputs and will operate from  $\pm 5V$  to  $\pm 15V$ . It is fabricated using Elantec's complementary bipolar process which allows both fast PNP and NPN transistors to be manufactured on a single chip.

Elantec's products and facilities comply with MIL-STD-883 Revision C, MIL-I-45208A, and other applicable quality specifications. For information on Elantec's military processing, see Elantec document, QRA-2: "Elantec's Military Processing, Monolithic Integrated Circuits".

## Connection Diagrams

EL2223J/CN

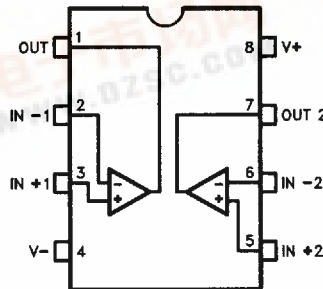

2223-1

EL2223L

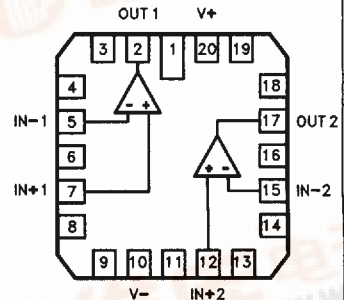

2223-2

EL2223CM

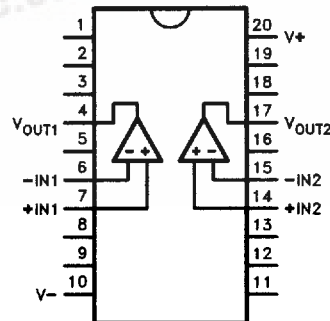

2223-3



**EL2223/EL2223C**

ELANTEC INC

**Dual, 500 MHz High Speed, Operational Amplifier****Absolute Maximum Ratings** ( $T_A = 25^\circ\text{C}$ )

Voltage between V+ and V-	35V	Storage Temperature Range	-65°C to +150°C
Differential Input Voltage	±6V	Maximum Junction Temperature	
Internal Power Dissipation	See Curves	CerDIP, LCC	175°C
Peak Output Current	Short Circuit Protected	Plastic DIP, SOL	150°C
Output Short Circuit Duration (Note 1)	Continuous	Lead Temperature	
Operational Temperature Range		DIP Package	300°C
EL2223	-55°C to +125°C	SOL Package	
EL2223C	0°C to +75°C	Vapor Phase (60 seconds)	215°C
		Infrared (15 seconds)	220°C

**Important Note:**

All parameters having Min/Max specifications are guaranteed. The Test Level column indicates the specific device testing actually performed during production and Quality Inspection. Elantec performs most electrical tests using modern high-speed automatic test equipment, specifically the LTX77 Series system. Unless otherwise noted, all tests are pulsed tests, therefore  $T_J = T_C = T_A$ .

Test Level	Test Procedure
I	100% production tested and QA sample tested per QA test plan QCX0002.
II	100% production tested at $T_A = 25^\circ\text{C}$ and QA sample tested at $T_A = 25^\circ\text{C}$ , $T_{MAX}$ and $T_{MIN}$ per QA test plan QCX0002.
III	QA sample tested per QA test plan QCX0002.
IV	Parameter is guaranteed (but not tested) by Design and Characterization Data.
V	Parameter is typical value at $T_A = 25^\circ\text{C}$ for information purposes only.

**DC Electrical Characteristics**  $V_S = \pm 15\text{V}$ ;  $R_L = 2\text{ k}\Omega$ , unless otherwise specified

Parameter	Description	Temp	EL2223				EL2223C				Units
			Min	Typ	Max	Test Level	Min	Typ	Max	Test Level	
$V_{OS}$	Offset Voltage	+25°C			5	I			5	I	mV
		Full	0.5		8	I	0.5		8	III	mV
$TCV_{OS}$	Average Offset Voltage Drift	Full		3		V		3		V	$\mu\text{V}/^\circ\text{C}$
$I_B$	Bias Current	+25°C			4	I			4	I	$\mu\text{A}$
		Full	1.5		6	I	1.5		6	III	$\mu\text{A}$
$I_{OS}$	Offset Current	+25°C			2	I			2	I	$\mu\text{A}$
		Full	0.2		3	I	0.2		3	III	$\mu\text{A}$
$R_{IN}$	Input Resistance	+25°C		6		V		6		V	k $\Omega$
$C_{IN}$	Input Capacitance	+25°C		1		V		1		V	pF
$V_{CM}$	Common Mode Input Range	Full	±10	±12		I	±10	±12		II	V
$e_{IN}$	Input Noise Voltage ( $f = 1\text{ kHz}$ , $R_G = 0\Omega$ )	+25°C		7		V		7		V	$\text{nV}/\sqrt{\text{Hz}}$
$A_{VOL}$	Large Signal Voltage Gain (Notes 2, 3)	+25°C	20k	40k		I	20k	40k		I	V/V
		Full	10k			I	10k			III	V/V

ELANTEC INC

# EL2223/EL2223C

## Dual, 500 MHz High Speed, Operational Amplifier

EL2223/EL2223C

### DC Electrical Characteristics $V_S = \pm 15V$ ; $R_L = 2\text{ k}\Omega$ , unless otherwise specified — Contd.

Parameter	Description	Temp	EL2223				EL2223C				Units
			Min	Typ	Max	Test Level	Min	Typ	Max	Test Level	
CMRR	Common-Mode Rejection Ratio (Note 4)	Full	70	90		I	70	90		II	dB
$V_O$	Output Voltage Swing	Full	$\pm 11$	$\pm 12.5$		I	$\pm 11$	$\pm 12.5$		II	V
$I_{SC}$	Short Circuit Current	+25°C		$\pm 50$	$\pm 70$	I		$\pm 50$	$\pm 70$	I	mA
$R_O$	Output Resistance	+25°C		40		V		40		V	$\Omega$
$I_S$	Supply Current	Full		9.5	13	I		9.5	13	II	mA
PSRR	Power Supply Rejection Ratio (Note 5)	Full	70	90		I	70	90		II	dB

### AC Electrical Characteristics $V_S = \pm 15V$ ; $R_L = 2\text{ k}\Omega$ , unless otherwise specified

Parameter	Description	Temp	EL2223				EL2223C				Units
			Min	Typ	Max	Test Level	Min	Typ	Max	Test Level	
$f_u$	Open Loop Unity Bandwidth (Note 6)	+25°C		500		V		500		V	MHz
FPBW	Full Power Bandwidth (Notes 2, 7)	+25°C	3.98	5.5		I	3.98	5.5		I	MHz
$t_r$	Rise Time (Note 8)	+25°C		7		V		7		V	ns
OS	Overshoot (Note 8)	+25°C		30		V		30		V	%
SR	Slew Rate (Note 8)	+25°C	250	350		I	250	350		I	V/ $\mu$ s
$t_s$	Settling Time (Notes 9, 10) 10V Step to 0.05%	+25°C		330		V		330		V	ns
Ch $S_p$	Channel Separation ( $f = 10\text{ MHz}$ )			70		V		70		V	dB

Note 1: A heat sink is required to keep the junction temperature below absolute maximum when the output is shorted.

Note 2:  $V_O = \pm 10V$ .

Note 3:  $R_L = 2\text{ k}\Omega$ .

Note 4: Two tests are performed.  $V_{CM} = 0V$  to +10V and  $V_{CM} = 0V$  to -10V.

Note 5: Two tests are performed.  $V_+ = 15V$ , and  $V_-$  is changed from -5V to -15V.  $V_- = -15V$ , and  $V_+$  is changed from +5V to +15V.

Note 6:  $V_O = 100\text{ mV}$ .

Note 7: Full Power Bandwidth guaranteed based on slew rate measurement using:  $FPBW = \text{Slew Rate} / 2\pi V_{peak}$ .

Note 8: Refer to Test Circuit section of data sheet.

Note 9: Settling time measurement are made with techniques in the following reference: "Take The Guesswork Out of Settling-Time Measurements," EDN September 19, 1985.

Note 10:  $A_V = +10$ ,  $R_L = 2\text{ k}\Omega$ .

1

# EL2223/EL2223C

ELANTEC INC

Dual, 500 MHz High Speed, Operational Amplifier

## Typical Performance Curves

Input Offset Voltage vs Supply Voltage

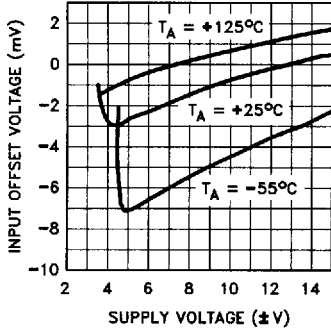

2223-4

Normalized Input Offset Voltage vs Temperature

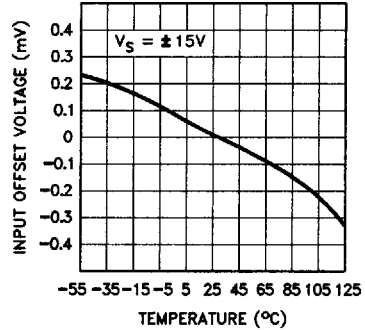

2223-5

Input Current vs Temperature

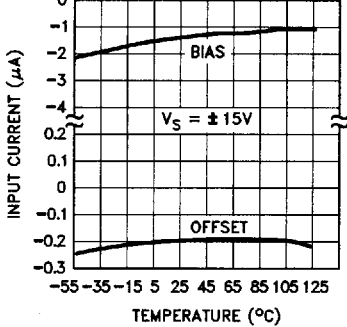

2223-6

Supply Current vs Supply Voltage

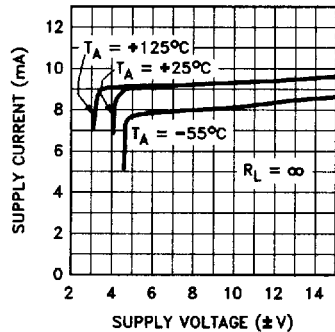

2223-7

Voltage Gain vs Temperature

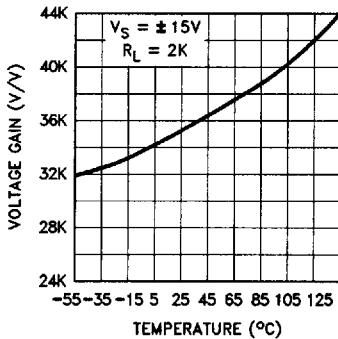

2223-8

Open Loop Voltage Gain vs Frequency

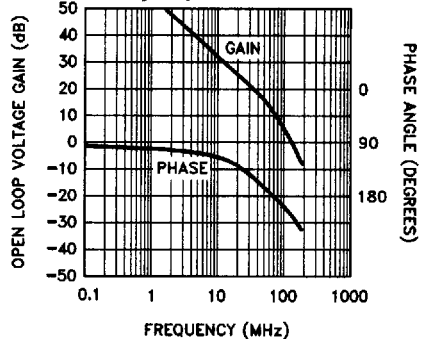

2223-9

ELANTEC INC

# EL2223/EL2223C

## Dual, 500 MHz High Speed, Operational Amplifier

EL2223/EL2223C

### Typical Performance Curves — Contd.

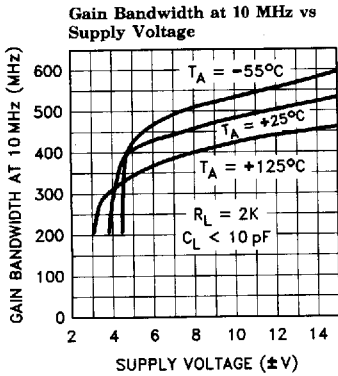

2223-10

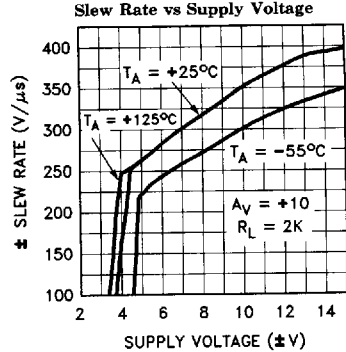

2223-11

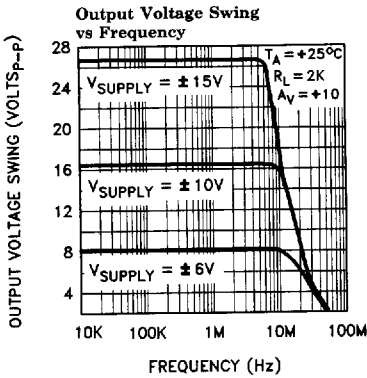

2223-12

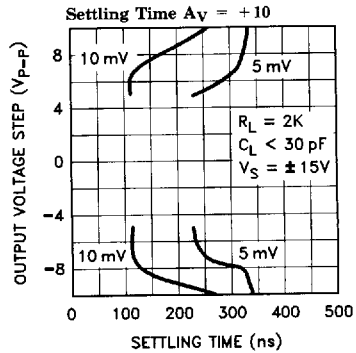

2223-13

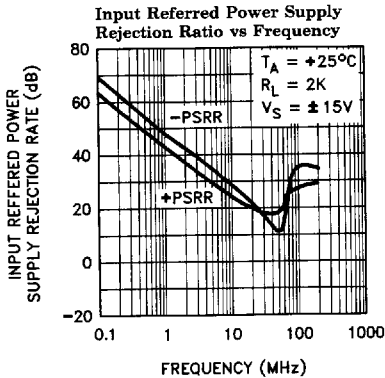

2223-14

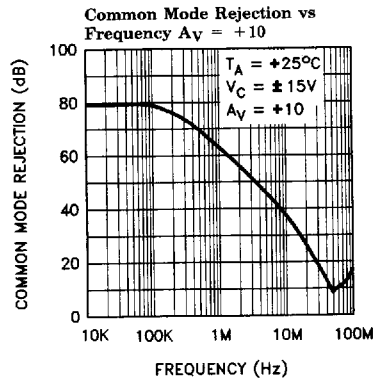

2223-15

# EL2223/EL2223C

ELANTEC INC

## Dual, 500 MHz High Speed, Operational Amplifier

### Typical Performance Curves — Contd.

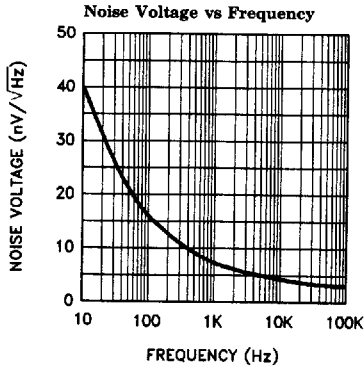

2223-16

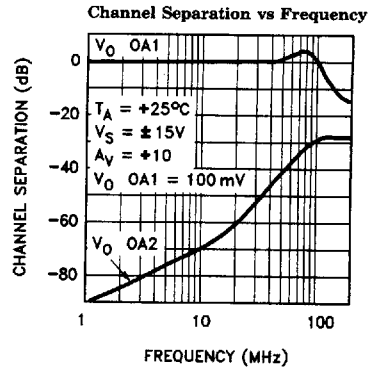

2223-17

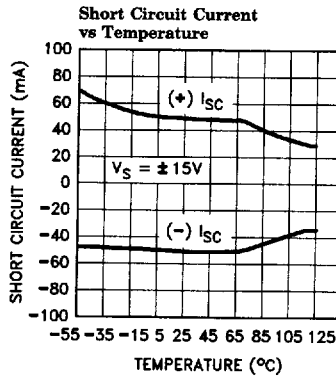

2223-18

### Large Signal Response

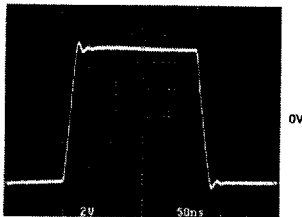

$A_V = +10$   
 $V_{IN} = \pm 0.5\text{V}$   
 $V_O = \pm 5\text{V}$   
 $R_L = 2\text{k}$

2223-19

### Small Signal Response

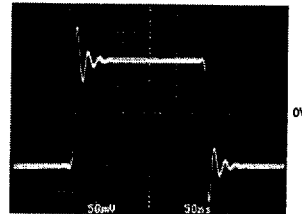

$A_V = +10$   
 $V_{IN} = \pm 10\text{ mV}$   
 $V_O = \pm 100\text{ mV}$   
 $R_L = 2\text{k}$

2223-20

ELANTEC INC

# EL2223/EL2223C

## Dual, 500 MHz High Speed, Operational Amplifier

EL2223/EL2223C

1

### Typical Performance Curves — Contd.

8-Lead CerDIP Maximum Power Dissipation vs Ambient Temperature

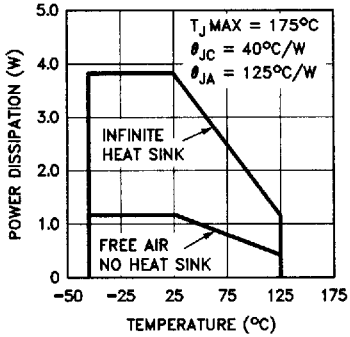

2223-21

8-Lead Plastic DIP Maximum Power Dissipation vs Ambient Temperature

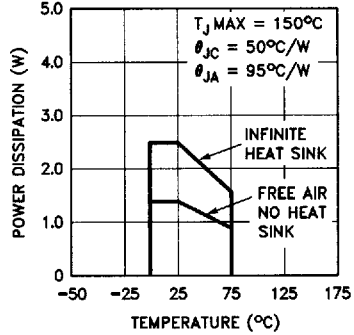

2223-22

20-Pad LCC Maximum Power Dissipation vs Ambient Temperature

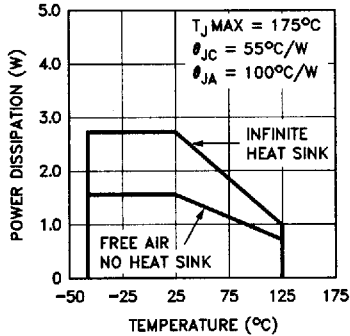

2223-23

20-Lead SOL Maximum Power Dissipation vs Ambient Temperature

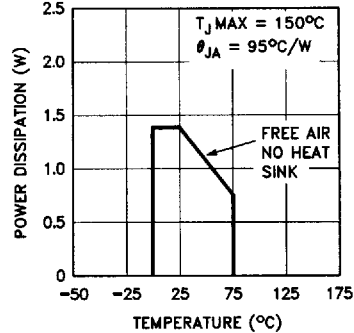

2223-24

### Test Circuit

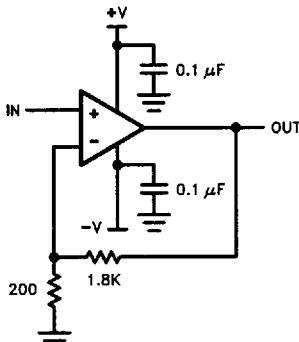

2223-27

$A_V = +10$   
 $C_L \leq 10 \text{ pF}$  Scope Probe

### Burn-In Circuit

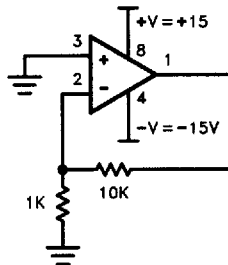

2223-28

Pin numbers are for the 8-Lead CerDIP.  
 Burn-in circuit is identical for all package types.

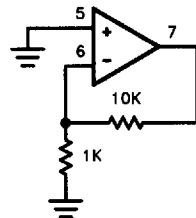

2223-28

# EL2223/EL2223C

ELANTEC INC

Dual, 500 MHz High Speed, Operational Amplifier

Simplified Schematic (one amplifier)

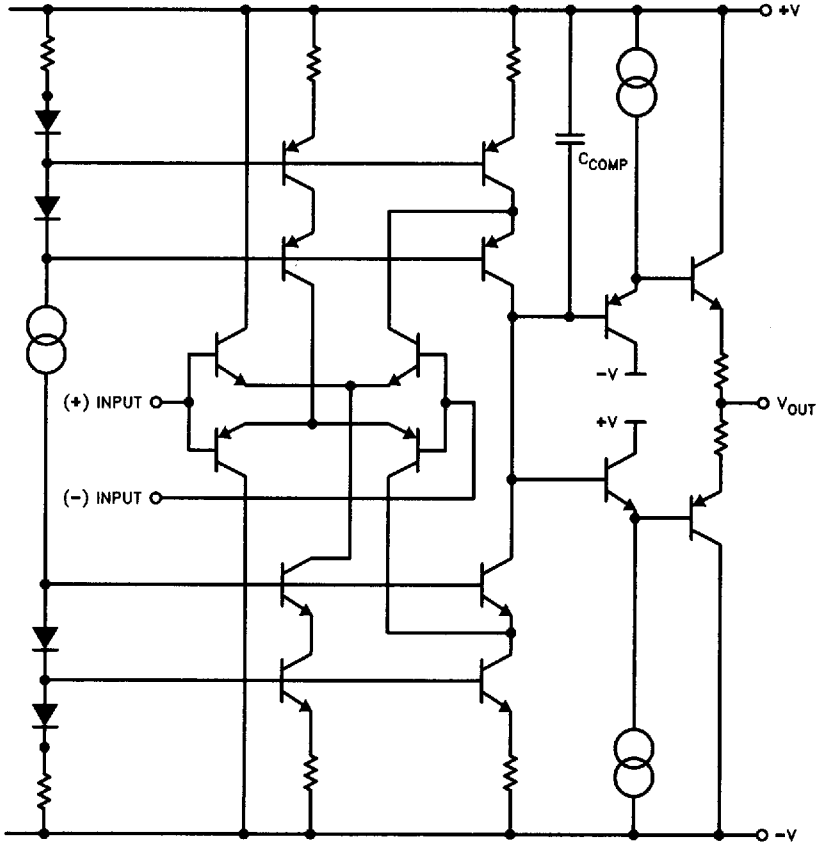



ELANTEC INC

**EL2223/EL2223C**  
*Dual, 500 MHz High Speed, Operational Amplifier*

EL2223/EL2223C

**EL2223 Macromodel**

```

* Connections:      + input
*                   |
*                   | - input
*                   |   +Vsupply
*                   |   -Vsupply
*                   |   output
*                   |
.subckt M2233      3   2   7   4   6

```

\* Input stage

```

ie 37 4 2mA
r6 36 37 60
r7 38 37 60
rc1 7 30 75
rc2 7 39 75
q1 30 3 36 qn
q2 39 2 38 qna
ediff 33 0 39 30 7.25
rdiff 33 0 1Meg

```

\* Compensation Section

```

ga 0 34 33 0 2.6m
rh 34 0 3Meg
ch 34 0 1.5pF
rc 34 40 600
cc 40 0 7pF

```

\* Poles

```

ep 41 0 40 0 1
rpa 41 42 75
cpa 42 0 25pF
rpb 42 43 50
cpb 43 0 15pF

```

\* Output Stage

```

ios1 7 50 1.25mA
ios2 51 4 1.25mA
q3 4 43 50 qp
q4 7 43 51 qn
q5 7 50 52 qn
q6 4 51 53 qp
ros1 52 6 25
ros2 6 53 25

```

\* models

```

.model qn npn (is = 800.0E - 18 bf = 250 tf = 0.2nS)
.model qna npn (is = 864E - 18 bf = 300 tf = 0.2nS)
.model qp pnp (is = 800E - 18 bf = 60 tf = 0.2nS)
.ends

```

# EL2223/EL2223C

ELANTEC INC

Dual, 500 MHz High Speed, Operational Amplifier

## EL2223 Macromodel — Contd.

