

**élantec**  
HIGH PERFORMANCE ANALOG INTEGRATED CIRCUITS

# EL2386C

250 MHz Triple Current Feedback Amp w/Disable

EL2386C

## Features

- Triple amplifier topology
- 3 mA supply current (per amplifier)
- 250 MHz – 3 dB bandwidth
- Low cost
- Fast disable
- Powers down to 0 mA
- Single- and dual-supply operation down to  $\pm 1.5V$
- 0.05%/0.05° Diff. gain/Diff. phase into 150 $\Omega$
- 1200V/ $\mu s$  slew rate
- Large output drive current: 55 mA
- Available in single (EL2186C) and dual (EL2286C) form
- Non-power down versions available in single, dual, and quad (EL2180C, EL2280C, EL2480C)
- Lower power EL2170C/EL2176C family also available (1 mA/70 MHz) in single, dual and quad.

## Applications

- Low power/battery applications
- HDSL amplifiers
- Video amplifiers
- Cable drivers
- RGB amplifiers
- Test equipment amplifiers
- Current to voltage converters
- Multiplexing
- Video broadcast equipment

## Ordering Information

Part No.	Temp. Range	Package	Outline #
EL2386CN	-40°C to +85°C	16-Pin PDIP	MDP0031
EL2386CS	-40°C to +85°C	16-Pin SOIC	MDP0027

## General Description

The EL2386C is a triple current-feedback operational amplifier which achieves a – 3 dB bandwidth of 250 MHz at a gain of +1 while consuming only 3 mA of supply current per amplifier. It will operate with dual supplies ranging from  $\pm 1.5V$  to  $\pm 6V$ , or from single supplies ranging from +3V to +12V. The EL2386C also includes a disable/power-down feature which reduces current consumption to 0 mA while placing the amplifier output in a high impedance state. In spite of its low supply current, the EL2386C can output 55 mA while swinging to  $\pm 4V$  on  $\pm 5V$  supplies. These attributes make the EL2386C an excellent choice for low power and/or low voltage cable-driver, HDSL, or RGB applications.

For Single and Dual applications, consider the EL2186C/EL2286C. For Single, Dual and Quad applications without disable, consider the EL2180C, EL2280C, or EL2480C, all in industry standard pin outs. The EL2180C also is available in the tiny SOT-23 package, which is 28% the size of an SO8 package. For lower power applications where speed is still a concern, consider the EL2170C/EL2176C family which also comes in similar Single, Dual and Quad configurations. The EL2170C/EL2176C family provides a – 3 dB bandwidth of 70 MHz while consuming 1 mA of supply current per amplifier.

## Connection Diagram

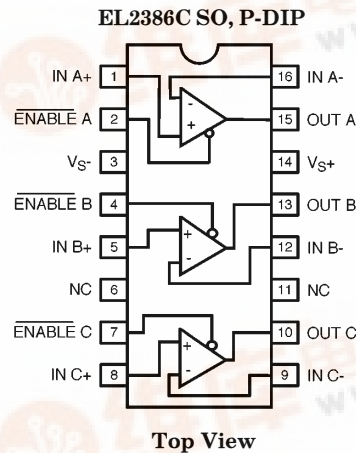

Manufactured under U.S. Patent No. 5,418,495.

Note: All information contained in this data sheet has been carefully checked and is believed to be accurate as of the date of publication; however, this data sheet cannot be a "controlled document". Current revisions, if any, to these specifications are maintained at the factory and are available upon your request. We recommend checking the revision level before finalization of your design documentation.

©1996 Elantec, Inc.

June 1996 Rev A



# EL2386C

## 250 MHz Triple Current Feedback Amp w/Disable

### Absolute Maximum Ratings ( $T_A = 25^\circ\text{C}$ )

Voltage between $V_{S+}$ and $V_{S-}$	+12.6V	Operating Ambient Temperature Range	-40°C to +85°C
Common-Mode Input Voltage	$V_{S-}$ to $V_{S+}$	Operating Junction Temperature	150°C
Differential Input Voltage	$\pm 6\text{V}$	Output Current	$\pm 60\text{ mA}$
Current into +IN or -IN	$\pm 7.5\text{ mA}$	Storage Temperature Range	-65°C to +150°C
Internal Power Dissipation	See Curves		

#### Important Note:

All parameters having Min/Max specifications are guaranteed. The Test Level column indicates the specific device testing actually performed during production and Quality inspection. Elantec performs most electrical tests using modern high-speed automatic test equipment, specifically the LTX77 Series system. Unless otherwise noted, all tests are pulsed tests, therefore  $T_J = T_C = T_A$ .

Test Level	Test Procedure
I	100% production tested and QA sample tested per QA test plan QCX0002.
II	100% production tested at $T_A = 25^\circ\text{C}$ and QA sample tested at $T_A = 25^\circ\text{C}$ , $T_{MAX}$ and $T_{MIN}$ per QA test plan QCX0002.
III	QA sample tested per QA test plan QCX0002.
IV	Parameter is guaranteed (but not tested) by Design and Characterization Data.
V	Parameter is typical value at $T_A = 25^\circ\text{C}$ for information purposes only.

### DC Electrical Characteristics

$V_S = \pm 5\text{V}$ ,  $R_L = 150\Omega$ ,  $\overline{\text{ENABLE}} = 0\text{V}$ ,  $T_A = 25^\circ\text{C}$  unless otherwise specified

Parameter	Description	Conditions	Min	Typ	Max	Test Level	Units
$V_{OS}$	Input Offset Voltage			2.5	15	I	mV
$TCV_{OS}$	Average Input Offset Voltage Drift	Measured from $T_{MIN}$ to $T_{MAX}$		5		V	$\mu\text{V}/^\circ\text{C}$
$dV_{OS}$	VOS Matching			0.5		V	mV
+ $I_{IN}$	+ Input Current			1.5	15	I	$\mu\text{A}$
d+ $I_{IN}$	+ $I_{IN}$ Matching			20		V	nA
- $I_{IN}$	- Input Current			16	40	I	$\mu\text{A}$
d- $I_{IN}$	- $I_{IN}$ Matching			2		V	$\mu\text{A}$
CMRR	Common Mode Rejection Ratio	$V_{CM} = \pm 3.5\text{V}$	45	50		I	dB
-ICMR	- Input Current Common Mode Rejection	$V_{CM} = \pm 3.5\text{V}$		5	30	I	$\mu\text{A}/\text{V}$
PSRR	Power Supply Rejection Ratio	$V_S = \pm 4\text{V}$ to $\pm 6\text{V}$	60	70		I	dB
-IPSR	- Input Current Power Supply Rejection	$V_S = \pm 4\text{V}$ to $\pm 6\text{V}$		1	15	I	$\mu\text{A}/\text{V}$
$R_{OL}$	Transimpedance	$V_{OUT} = \pm 2.5\text{V}$	120	300		I	k $\Omega$
+ $R_{IN}$	+ Input Resistance	$V_{CM} = \pm 3.5\text{V}$	0.5	2		I	M $\Omega$
+ $C_{IN}$	+ Input Capacitance			1.2		V	pF
CMIR	Common Mode Input Range		$\pm 3.5$	$\pm 4.0$		I	V
$V_O$	Output Voltage Swing	$V_S = \pm 5\text{V}$	$\pm 3.5$	$\pm 4.0$		I	V
		$V_S = +5\text{V}$ Single-Supply, High		4.0		V	V
		$V_S = +5\text{V}$ Single-Supply, Low		0.3		V	V
$I_O$	Output Current		50	55		I	mA

# EL2386C

## 250 MHz Triple Current Feedback Amp w/Disable

### DC Electrical Characteristics

$V_S = \pm 5V$ ,  $R_L = 150 \Omega$ ,  $\overline{ENABLE} = 0V$ ,  $T_A = 25^\circ C$  unless otherwise specified — Contd.

Parameter	Description	Conditions	Min	Typ	Max	Test Level	Units
$I_S$	Supply Current—Enabled (per amplifier)	$\overline{ENABLE} = 2.0V$		3	6	I	mA
$I_{S(DIS)}$	Supply Current—Disabled (per amplifier)	$\overline{ENABLE} = 4.5V$		0	50	I	$\mu A$
$C_{OUT(DIS)}$	Output Capacitance—Disabled	$\overline{ENABLE} = 4.5V$		4.4		V	pF
$R_{IN-EN}$	$\overline{ENABLE}$ Pin Input Resistance	$\overline{ENABLE} = 2.0V$ to $4.5V$	45	85		I	k $\Omega$
$I_{IH-EN}$	$\overline{ENABLE}$ Pin Input Current—High	$\overline{ENABLE} = 4.5V$		-0.04		V	$\mu A$
$I_{IL-EN}$	$\overline{ENABLE}$ Pin Input Current—Low	$\overline{ENABLE} = 0V$		-53		V	$\mu A$
$V_{DIS}$	Minimum Voltage at $\overline{ENABLE}$ to Disable		4.5			I	V
$V_{EN}$	Maximum Voltage at $\overline{ENABLE}$ to Enable				2.0	I	V

### AC Electrical Characteristics

$V_S = \pm 5V$ ,  $R_F = R_G = 750 \Omega$ ,  $R_L = 150\Omega$ ,  $\overline{ENABLE} = 0V$ ,  $T_A = 25^\circ C$  unless otherwise specified.

Parameter	Description	Conditions	Min	Typ	Max	Test Level	Units
BW	-3 dB Bandwidth	$A_V = +1$		250		V	MHz
		$A_V = +2$		180		V	MHz
BW	$\pm 0.1$ dB Bandwidth	$A_V = +2$		50		V	MHz
SR	Slew Rate	$V_{OUT} = \pm 2.5V$ , Measured at $\pm 1.25V$	600	1200		IV	V/ $\mu s$
$t_R, t_F$	Rise and Fall Time	$V_{OUT} = \pm 500$ mV		1.5		V	ns
$t_{PD}$	Propagation Delay	$V_{OUT} = \pm 500$ mV		1.5		V	ns
OS	Overshoot	$V_{OUT} = \pm 500$ mV		3.0		V	%
$t_S$	0.1% Settling	$V_{OUT} = \pm 2.5V$ , $A_V = -1$		15		V	ns
dG	Differential Gain (Note 1)	$A_V = +2$ , $R_L = 150\Omega$		0.05		V	%
dP	Differential Phase (Note 1)	$A_V = +2$ , $R_L = 150\Omega$ ,		0.05		V	$^\circ$
dG	Differential Gain (Note 1)	$A_V = +1$ , $R_L = 500\Omega$		0.01		V	%
dP	Differential Phase (Note 1)	$A_V = +1$ , $R_L = 500\Omega$		0.01		V	$^\circ$
$t_{ON}$	Turn-On Time (Note 2)	$A_V = +2$ , $V_{IN} = +1V$ , $R_L = 150\Omega$		40	100	I	ns
$t_{OFF}$	Turn-Off Time (Note 2)	$A_V = +2$ , $V_{IN} = +1V$ , $R_L = 150\Omega$		800	2000	I	ns
CS	Channel Separation	$f = 5$ MHz		85		V	dB

Note 1: DC offset from 0V to 0.714V, AC amplitude 286 mV<sub>p-p</sub>,  $f = 3.58$  MHz.

Note 2: Measured from the application of the logic signal until the output voltage is at the 50% point between initial and final values.

# EL2386C

## 250 MHz Triple Current Feedback Amp w/Disable

### Test Circuit (per Amplifier)

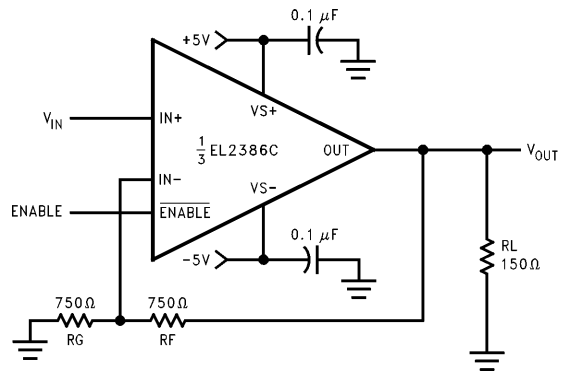

2386-2

### Simplified Schematic (per Amplifier)

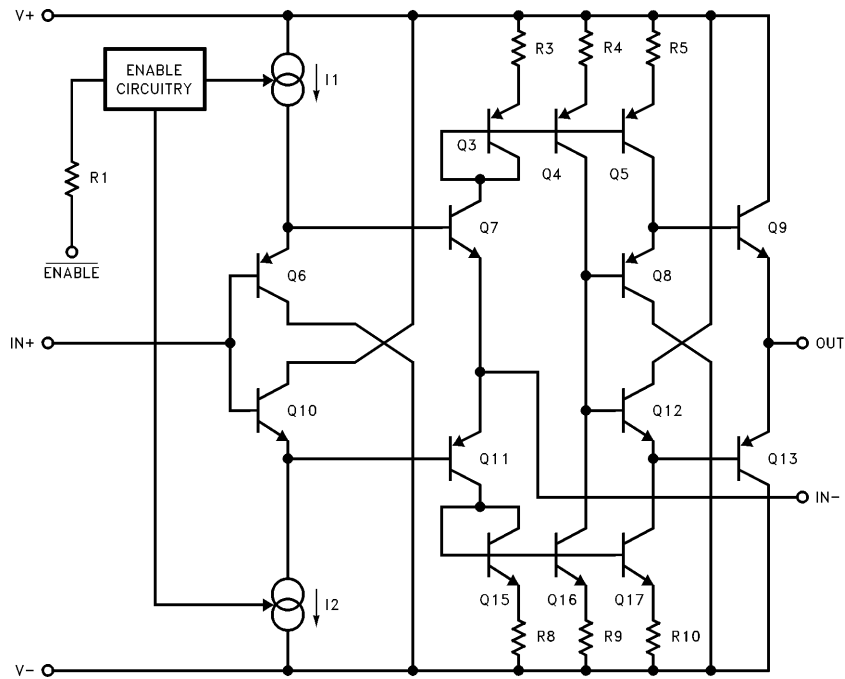

2386-3

# EL2386C

## 250 MHz Triple Current Feedback Amp w/Disable

### Typical Performance Curves — Contd.

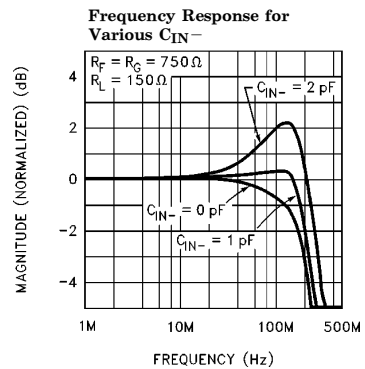
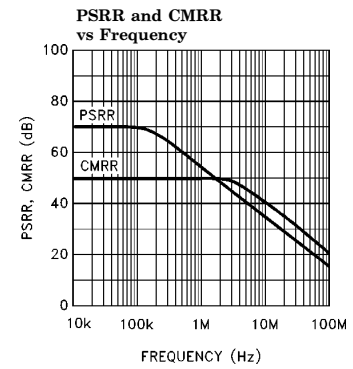
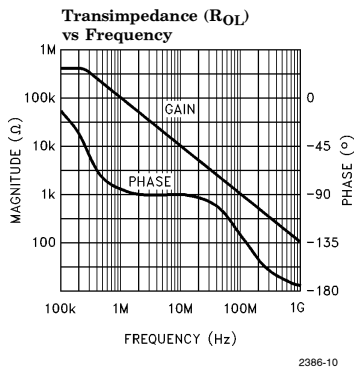
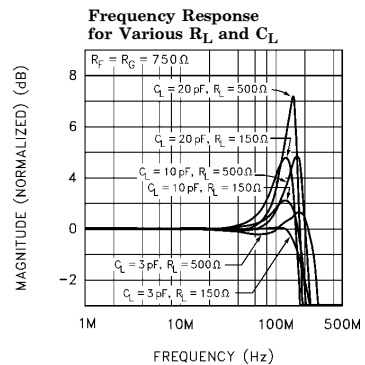
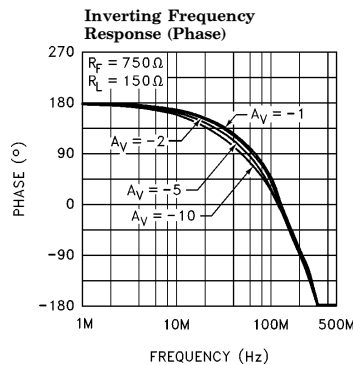
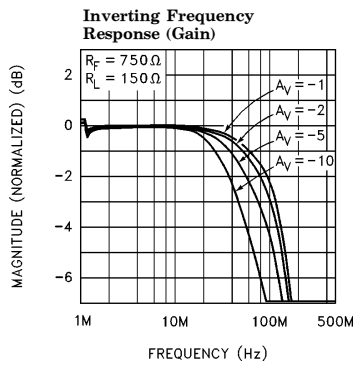
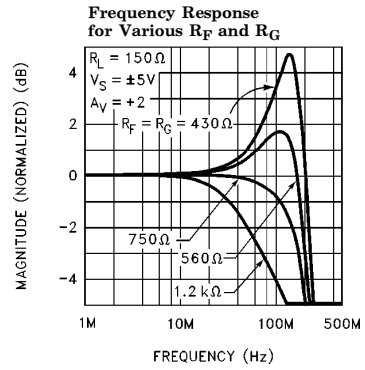
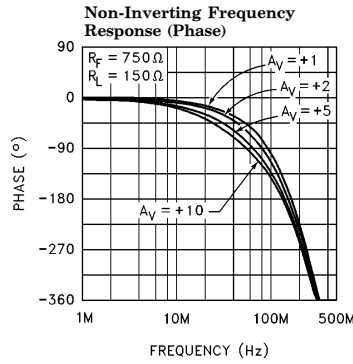
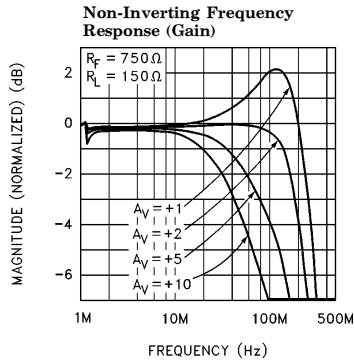

# EL2386C

## 250 MHz Triple Current Feedback Amp w/Disable

### Typical Performance Curves — Contd.

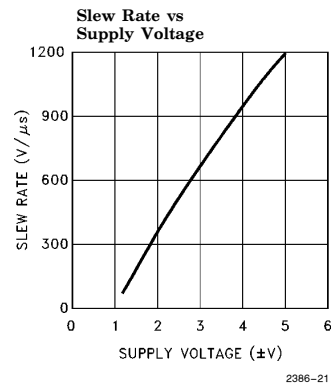
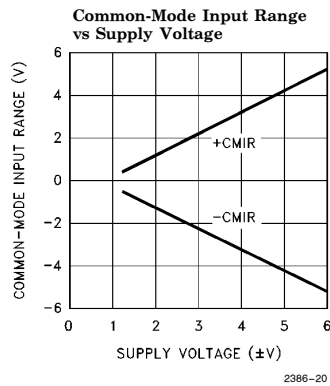
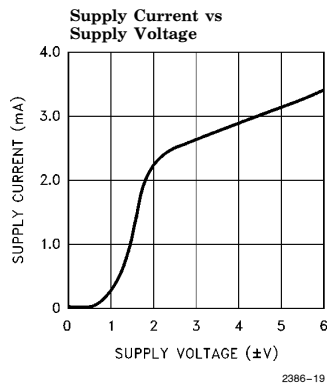
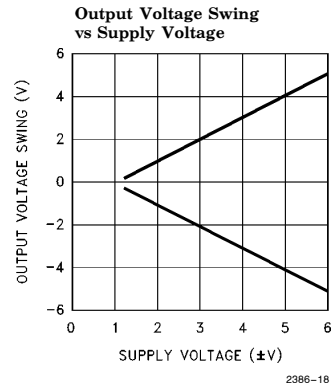
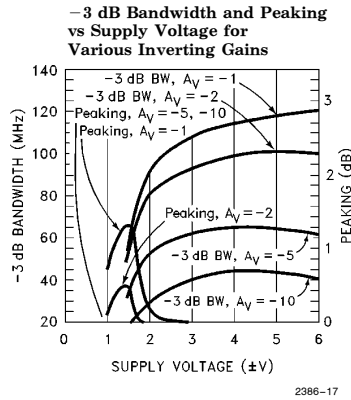
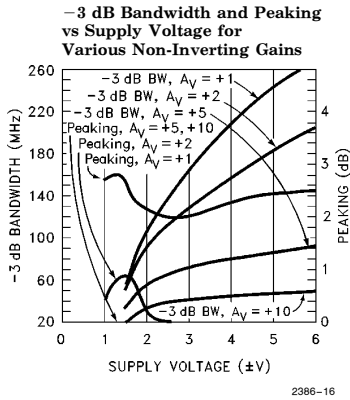
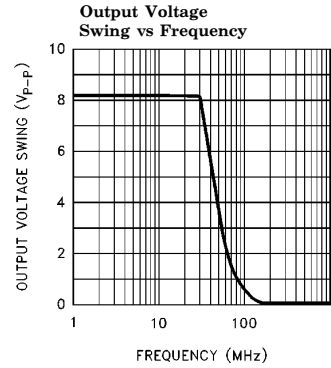
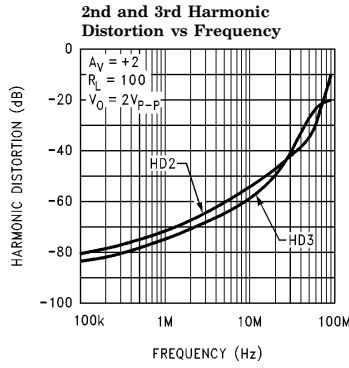
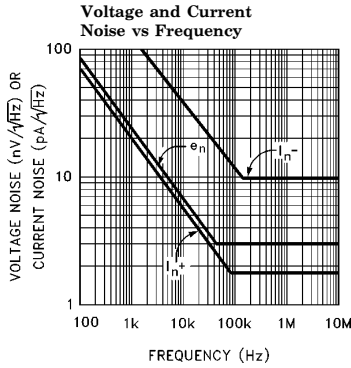

# EL2386C

## 250 MHz Triple Current Feedback Amp w/Disable

### Typical Performance Curves — Contd.

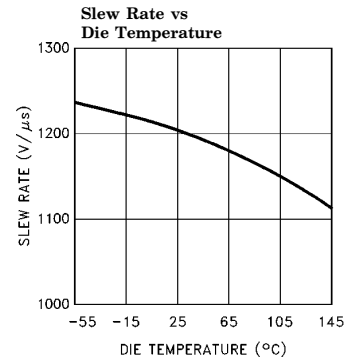
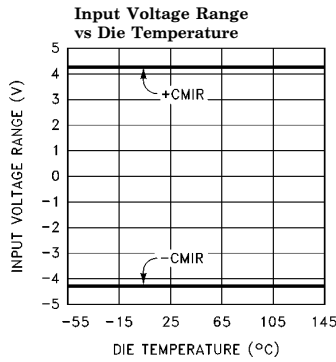
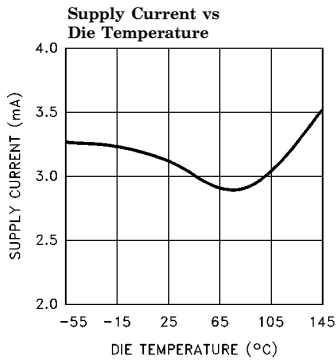
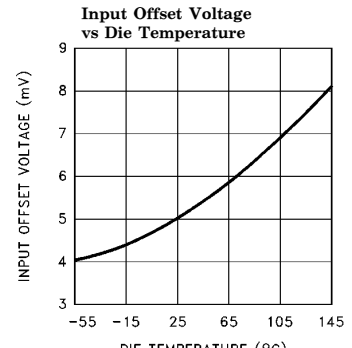
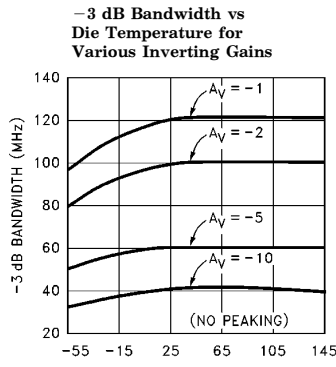
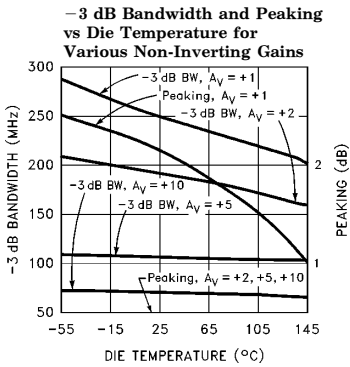
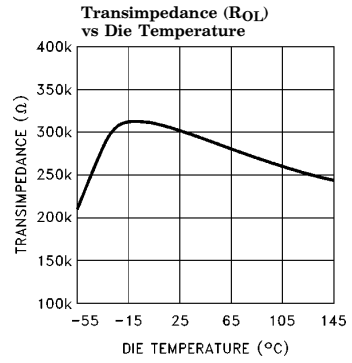
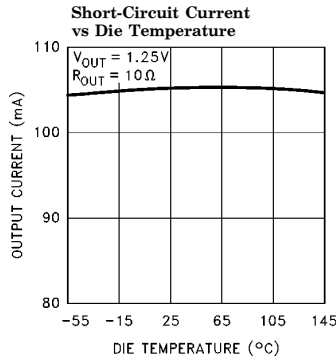
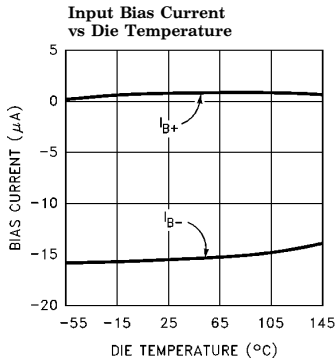

# EL2386C

## 250 MHz Triple Current Feedback Amp w/Disable

### Typical Performance Curves — Contd.

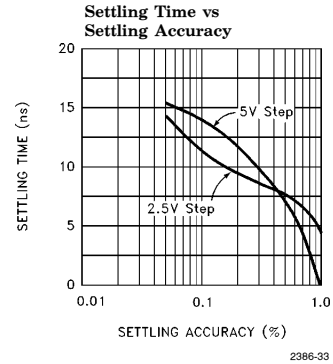
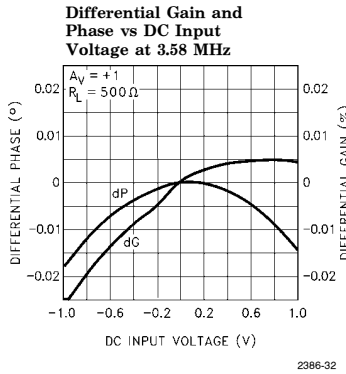
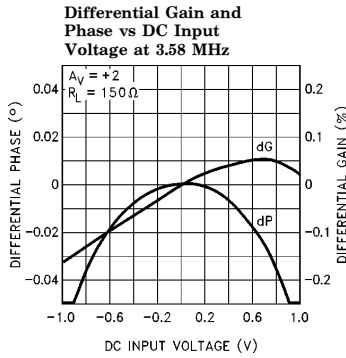

#### Small-Signal Step Response

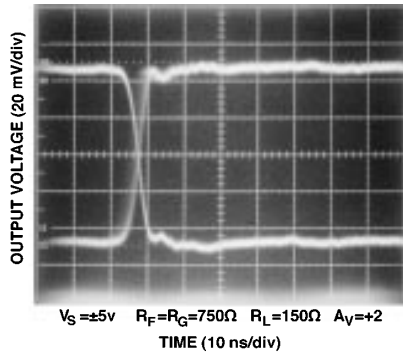

#### Large-Signal Step Response

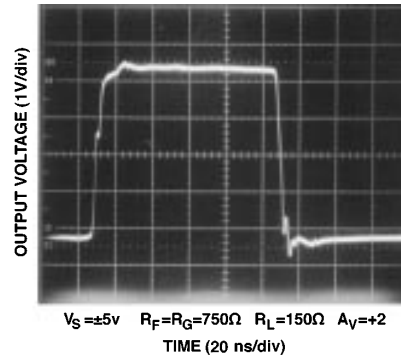

#### 16-Pin Plastic DIP Maximum Power Dissipation vs Ambient Temperature

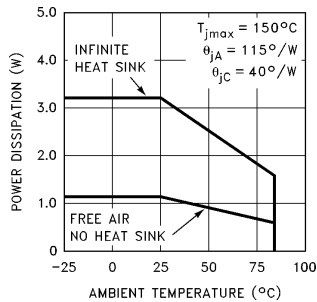

#### 16-Lead SO Maximum Power Dissipation vs Ambient Temperature

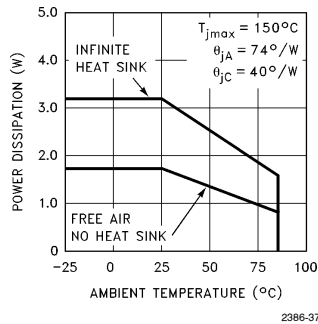

#### Channel to Channel Isolation vs Frequency

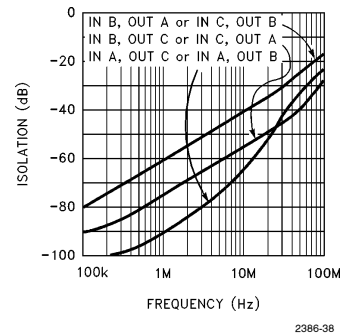



# EL2386C

## 250 MHz Triple Current Feedback Amp w/Disable

### Applications Information

#### Product Description

The EL2386C is a current-feedback operational amplifier that offers a wide  $-3$  dB bandwidth of 250 MHz, a low supply current of 3 mA per amplifier and the ability to power down to 0 mA. It also features high output current drive. The EL2386C can output 55 mA per amplifier. The EL2386C works with supply voltages ranging from a single 3V to  $\pm 6$ V, and it is also capable of swinging to within 1V of either supply on the input and the output. Because of its current-feedback topology, the EL2386C does not have the normal gain-bandwidth product associated with voltage-feedback operational amplifiers. This allows its  $-3$  dB bandwidth to remain relatively constant as closed-loop gain is increased. This combination of high bandwidth and low power, together with aggressive pricing make the EL2386C the ideal choice for many low-power/high-bandwidth applications such as portable computing, HDSL, and video processing.

For Single and Dual applications, consider the EL2186C/EL2286C. For Single, Dual and Quad applications without disable, consider the EL2180C, EL2280C, or EL2480C, all in industry standard pin outs. The EL2180C also is available in the tiny SOT-23 package, which is 28% the size of an SO8 package. For lower power applications where speed is still a concern, consider the EL2170C/EL2176C family which also comes in similar Single, Dual and Quad configurations with 70 MHz of bandwidth while consuming 1 mA of supply current per amplifier.

#### Power Supply Bypassing and Printed Circuit Board Layout

As with any high-frequency device, good printed circuit board layout is necessary for optimum performance. Ground plane construction is highly recommended. Lead lengths should be as short as possible. The power supply pins must be well bypassed to reduce the risk of oscillation. The combination of a 4.7  $\mu$ F tantalum capacitor in parallel with a 0.1  $\mu$ F capacitor has been shown to work well when placed at each supply pin. For single supply operation, where pin 3 ( $V_S$ ) is con-

nected to the ground plane, a single 4.7  $\mu$ F tantalum capacitor in parallel with a 0.1  $\mu$ F ceramic capacitor across pins 14 and 3 will suffice.

For good AC performance, parasitic capacitance should be kept to a minimum especially at the inverting input (see the Capacitance at the Inverting Input section). Ground plane construction should be used, but it should be removed from the area near the inverting input to minimize any stray capacitance at that node. Carbon or Metal-Film resistors are acceptable with the Metal-Film resistors giving slightly less peaking and bandwidth because of their additional series inductance. Use of sockets, particularly for the SO package should be avoided if possible. Sockets add parasitic inductance and capacitance which will result in some additional peaking and overshoot.

#### Disable/Power-Down

The EL2386C amplifier can be disabled, placing its output in a high-impedance state. When disabled, the supply current is reduced to 0 mA. The EL2386C is disabled when its  $\overline{\text{ENABLE}}$  pin is floating or pulled up to within 0.5V of the positive supply. Similarly, the amplifier is enabled by pulling its  $\overline{\text{ENABLE}}$  pin at least 3V below the positive supply. For  $\pm 5$ V supplies, this means that an EL2386C amplifier will be enabled when  $\overline{\text{ENABLE}}$  is at 2V or less, and disabled when  $\overline{\text{ENABLE}}$  is above 4.5V. Although the logic levels are not standard TTL, this choice of logic voltages allows the EL2386C to be enabled by tying  $\overline{\text{ENABLE}}$  to ground, even in  $+3$ V single-supply applications. The  $\overline{\text{ENABLE}}$  pin can be driven from CMOS outputs or open-collector TTL.

When enabled, supply current does vary somewhat with the voltage applied at  $\overline{\text{ENABLE}}$ . For example, with the supply voltages of the EL2186C at  $\pm 5$ V, if  $\overline{\text{ENABLE}}$  is tied to  $-5$ V (rather than ground) the supply current will increase about 15% to 3.45 mA.

# ***EL2386C***

## ***250 MHz Triple Current Feedback Amp w/Disable***

### **Applications Information — Contd.**

#### **Capacitance at the Inverting Input**

Any manufacturer's high-speed voltage- or current-feedback amplifier can be affected by stray capacitance at the inverting input. For inverting gains this parasitic capacitance has little effect because the inverting input is a virtual ground, but for non-inverting gains this capacitance (in conjunction with the feedback and gain resistors) creates a pole in the feedback path of the amplifier. This pole, if low enough in frequency, has the same destabilizing effect as a zero in the forward open-loop response. The use of large value feedback and gain resistors further exacerbates the problem by further lowering the pole frequency.

The experienced user with a large amount of PC board layout experience may find in rare cases that the EL2386C has less bandwidth than expected. In this case, the inverting input may have less parasitic capacitance than expected. The reduction of feedback resistor values (or the addition of a very small amount of external capacitance at the inverting input, e. g. 0.5 pF) will increase bandwidth as desired. Please see the curves for Frequency Response for Various  $R_F$  and  $R_G$ , and Frequency Response for Various  $C_{IN}$ .

#### **Feedback Resistor Values**

The EL2386C has been designed and specified at gains of +1 and +2 with  $R_F = 750\Omega$ . This value of feedback resistor gives 250 MHz of -3 dB bandwidth at  $A_V = +1$  with about 2.5 dB of peaking, and 180 MHz of -3 dB bandwidth at  $A_V = +2$  with about 0.1 dB of peaking. Since the EL2386C is a current-feedback amplifier, it is also possible to change the value of  $R_F$  to get more bandwidth. As seen in the curve of Frequency Response For Various  $R_F$  and  $R_G$ , bandwidth and peaking can be easily modified by varying the value of the feedback resistor.

Because the EL2386C is a current-feedback amplifier, its gain-bandwidth product is not a constant for different closed-loop gains. This feature actually allows the EL2386C to maintain about the same -3 dB bandwidth, regardless of closed-loop gain. However, as closed-loop gain is in-

creased, bandwidth decreases slightly while stability increases. Since the loop stability is improving with higher closed-loop gains, it becomes possible to reduce the value of  $R_F$  below the specified 750 $\Omega$  and still retain stability, resulting in only a slight loss of bandwidth with increased closed-loop gain.

#### **Supply Voltage Range and Single-Supply Operation**

The EL2386C has been designed to operate with supply voltages having a span of greater than 3V, and less than 12V. In practical terms, this means that the EL2386C will operate on dual supplies ranging from  $\pm 1.5V$  to  $\pm 6V$ . With a single-supply, the EL2386C will operate from +3V to +12V.

As supply voltages continue to decrease, it becomes necessary to provide input and output voltage ranges that can get as close as possible to the supply voltages. The EL2386C has an input voltage range that extends to within 1V of either supply. So, for example, on a single +5V supply, the EL2386C has an input range which spans from 1V to 4V. The output range of the EL2386C is also quite large, extending to within 1V of the supply rail. On a  $\pm 5V$  supply, the output is therefore capable of swinging from -4V to +4V. Single-supply output range is even larger because of the increased negative swing due to the external pull-down resistor to ground. On a single +5V supply, output voltage range is about 0.3V to 4V.

#### **Video Performance**

For good video performance, an amplifier is required to maintain the same output impedance and the same frequency response as DC levels are changed at the output. This is especially difficult when driving a standard video load of 150 $\Omega$ , because of the change in output current with DC level. Until the EL2386C, good Differential Gain could only be achieved by running high idle currents through the output transistors (to reduce variations in output impedance). These currents were typically comparable to the entire 3 mA supply current of each EL2386C amplifier! Spe-

# *EL2386C*

## *250 MHz Triple Current Feedback Amp w/Disable*

### Applications Information — Contd.

cial circuitry has been incorporated in the EL2386C to reduce the variation of output impedance with current output. This results in dG and dP specifications of 0.05% and 0.05° while driving 150Ω at a gain of +2.

Video Performance has also been measured with a 500Ω load at a gain of +1. Under these conditions, the EL2386C has dG and dP specifications of 0.01% and 0.01° respectively while driving 500Ω at  $A_V = +1$ .

For complete curves, see the Differential Gain and Differential Phase vs Input Voltage curves.

### Output Drive Capability

In spite of its low 3 mA of supply current per amplifier, the EL2386C is capable of providing a minimum of ±50 mA of output current. This output drive level is unprecedented in amplifiers running at these supply currents. With a minimum ±50 mA of output drive, the EL2386C is capable of driving 50Ω loads to ±2.5V, making it an excellent choice for driving multiple video loads in RGB applications.

### Driving Cables and Capacitive Loads

When used as a cable driver, double termination is always recommended for reflection-free performance. For those applications, the back-termination series resistor will decouple the EL2386C from the cable and allow extensive capacitive

drive. However, other applications may have high capacitive loads without a back-termination resistor. In these applications, a small series resistor (usually between 5Ω and 50Ω) can be placed in series with the output to eliminate most peaking. The gain resistor ( $R_G$ ) can then be chosen to make up for any gain loss which may be created by this additional resistor at the output. In many cases it is also possible to simply increase the value of the feedback resistor ( $R_F$ ) to reduce the peaking.

### Current Limiting

The EL2386C has no internal current-limiting circuitry. If an output is shorted indefinitely, the power dissipation could easily increase such that the part will be destroyed. Maximum reliability is maintained if the output current never exceeds ±60 mA. A heat sink may be required to keep the junction temperature below absolute maximum when an output is shorted indefinitely.

### Multiplexing with the EL2386C

The ENABLE pins on the EL2386C allow for multiplexing applications. Figure 1 shows an EL2386C with all 3 outputs tied together, driving a back terminated 75Ω video load. Three sine waves of varying amplitudes and frequencies are applied to the three inputs, while a 1 of 3 decoder selects one amplifier to be on at any given time. Figure 2 shows the resulting output wave form at

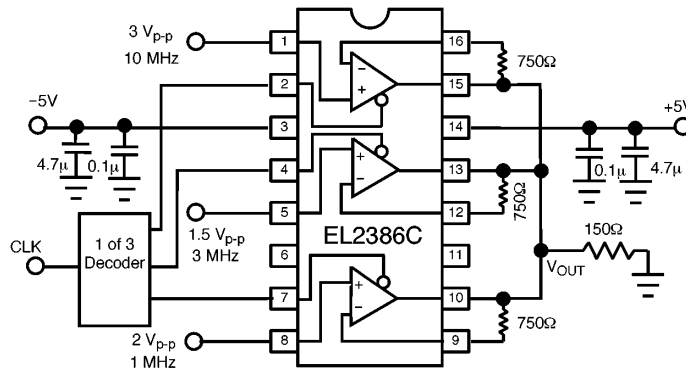

Figure 1

2386-39

# EL2386C

## 250 MHz Triple Current Feedback Amp w/Disable

### Applications Information — Contd.

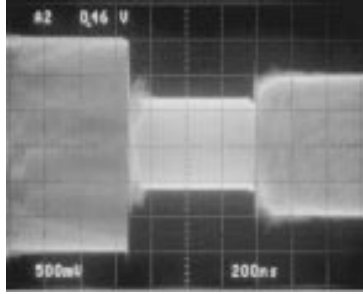

Figure 2

2386-40

$V_{OUT}$ . Switching is complete in about 100 ns. Notice the outputs are tied directly together. Decoupling resistors at each output are not required or advised when multiplexing.

#### Power Dissipation

With the high output drive capability of the EL2386C, it is possible to exceed the 150°C Absolute Maximum junction temperature under certain very high load current conditions. Generally speaking, when  $R_L$  falls below about 25 $\Omega$ , it is important to calculate the maximum junction temperature ( $T_{Jmax}$ ) for the application to determine if power-supply voltages, load conditions, or package type need to be modified for the EL2386C to remain in the safe operating area.

These parameters are calculated as follows:

$$T_{JMAX} = T_{MAX} + (\theta_{JA} * n * PD_{MAX}) \quad [1]$$

where:

$T_{MAX}$  = Maximum Ambient Temperature

$\theta_{JA}$  = Thermal Resistance of the Package

$n$  = Number of Amplifiers in the Package

$PD_{MAX}$  = Maximum Power Dissipation of Each Amplifier in the Package.

$PD_{MAX}$  for each amplifier can be calculated as follows:

$$PD_{MAX} = (2 * V_S * I_{SMAX}) + (V_S - V_{OUTMAX}) * (V_{OUTMAX} / R_L) \quad [2]$$

where:

$V_S$  = Supply Voltage

$I_{SMAX}$  = Maximum Supply Current of 1 Amplifier

$V_{OUTMAX}$  = Max. Output Voltage of the Application

$R_L$  = Load Resistance



# EL2386C

## 250 MHz Triple Current Feedback Amp w/Disable

### EL2386C Macromodel — Contd.

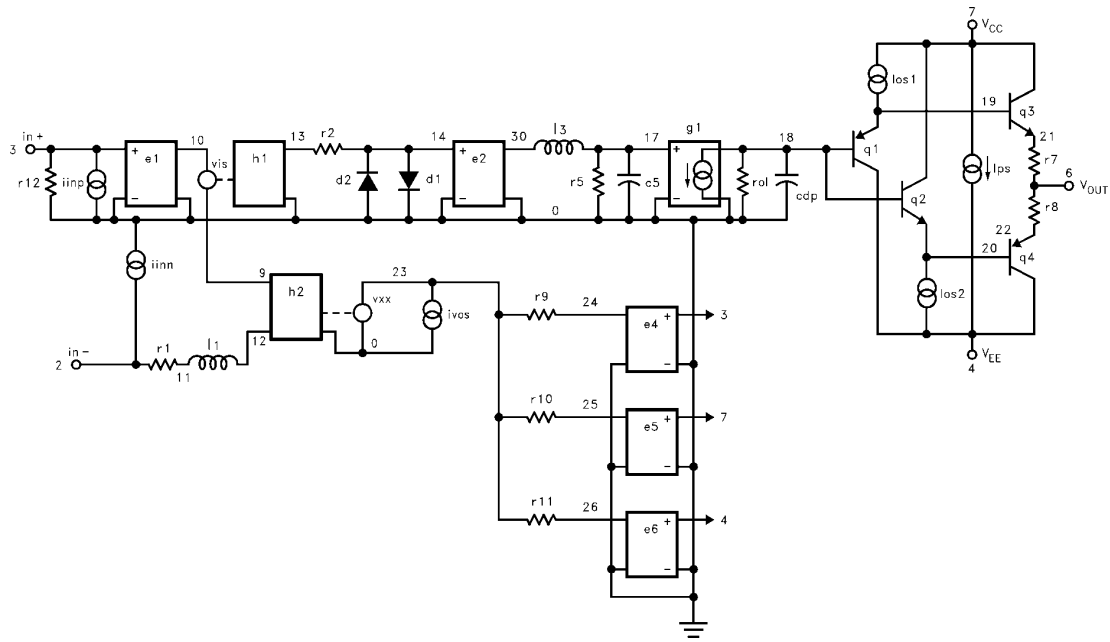

2386-41

**BLANK**

# ***EL2386C***

***250 MHz Triple Current Feedback Amp w/Disable***

## **General Disclaimer**

Specifications contained in this data sheet are in effect as of the publication date shown. Elantec, Inc. reserves the right to make changes in the circuitry or specifications contained herein at any time without notice. Elantec, Inc. assumes no responsibility for the use of any circuits described herein and makes no representations that they are free from patent infringement.

***élantec***  
HIGH PERFORMANCE ANALOG INTEGRATED CIRCUITS

## **Elantec, Inc.**

1996 Tarob Court

Milpitas, CA 95035

Telephone: (408) 945-1323

(800) 333-6314

Fax: (408) 945-9305

European Office: 44-71-482-4596

## **WARNING — Life Support Policy**

Elantec, Inc. products are not authorized for and should not be used within Life Support Systems without the specific written consent of Elantec, Inc. Life Support systems are equipment intended to support or sustain life and whose failure to perform when properly used in accordance with instructions provided can be reasonably expected to result in significant personal injury or death. Users contemplating application of Elantec, Inc. products in Life Support Systems are requested to contact Elantec, Inc. factory headquarters to establish suitable terms & conditions for these applications. Elantec, Inc.'s warranty is limited to replacement of defective components and does not cover injury to persons or property or other consequential damages.