

200MHz Rail-to-Rail Amplifiers

The EL8200, EL8201, and EL8401 represent rail-to-rail amplifiers with a -3dB bandwidth of 200MHz and slew rate of 200V/ μ s. Running off a very low supply current of 2mA per channel, the EL8200, EL8201, and EL8401 also feature inputs that go to 0.15V below the V_{S-} rail. The EL8200 and EL8201 are dual channel amplifiers. The EL8401 is a quad channel amplifier.

The EL8200 includes a fast-acting disable/power-down circuit. With a 25ns disable and a 200ns enable, the EL8200 is ideal for multiplexing applications.

The EL8200, EL8201, and EL8401 are designed for a number of general purpose video, communication, instrumentation, and industrial applications. The EL8200 is available in a 10 Ld MSOP package, the EL8201 in an 8 Ld SO and 8 Ld MSOP package, and the EL8401 in a 14 Ld SO and 16 Ld QSOP packages. All are specified for operation over the -40°C to +85°C temperature range.

Features

- 200MHz -3dB bandwidth
- 200V/ μ s slew rate
- Low supply current = 2mA per channel
- Supplies from 3V to 5.5V
- Rail-to-rail output
- Input to 0.15V below V_{S-}
- Fast 25ns disable (EL8200 only)
- Low cost
- Pb-free available (RoHS compliant)

Applications

- Video amplifiers
- Portable/hand-held products
- Communications devices

Pinouts

EL8201
(8 LD SO, 8 LD MSOP)
TOP VIEW

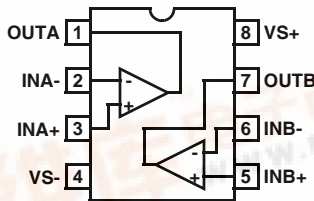

EL8200
(10 LD MSOP)
TOP VIEW

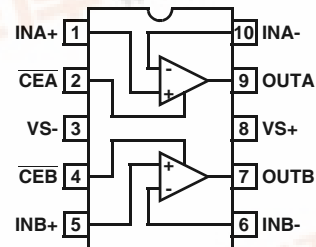

EL8401
(14 LD SO)
TOP VIEW

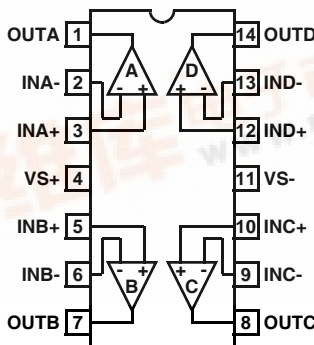

EL8401
(16 LD QSOP)
TOP VIEW

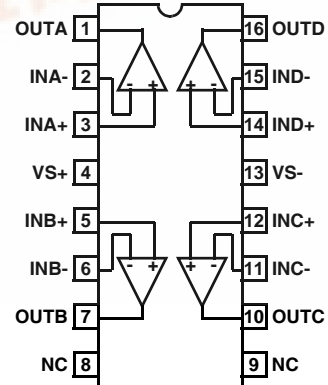

EL8200, EL8201, EL8401

Ordering Information

PART NUMBER	PART MARKING	PACKAGE	PKG. DWG. #
EL8200IY	j	10 Ld MSOP	MDP0043
EL8200IY-T7*	j	10 Ld MSOP	MDP0043
EL8200IY-T13*	j	10 Ld MSOP	MDP0043
EL8200IYZ (See Note)	BAMAA	10 Ld MSOP (Pb-free)	MDP0043
EL8200IYZ-T7* (See Note)	BAMAA	10 Ld MSOP (Pb-free)	MDP0043
EL8200IYZ-T13* (See Note)	BAMAA	10 Ld MSOP (Pb-free)	MDP0043
EL8201IS	8201IS	8 Ld SO	MDP0027
EL8201IS-T7*	8201IS	8 Ld SO	MDP0027
EL8201IS-T13*	8201IS	8 Ld SO	MDP0027
EL8201ISZ (See Note)	8201ISZ	8 Ld SO (Pb-free)	MDP0027
EL8201ISZ-T7* (See Note)	8201ISZ	8 Ld SO (Pb-free)	MDP0027
EL8201ISZ-T13* (See Note)	8201ISZ	8 Ld SO (Pb-free)	MDP0027
<i>Coming Soon</i> EL8201IYZ (See Note)		8 Ld MSOP (Pb-free)	MDP0043
<i>Coming Soon</i> EL8201IYZ-T7* (See Note)		8 Ld MSOP (Pb-free)	MDP0043
<i>Coming Soon</i> EL8201IYZ-T13* (See Note)		8 Ld MSOP (Pb-free)	MDP0043
EL8401IS	8401IS	14 Ld SO	MDP0027
EL8401IS-T7*	8401IS	14 Ld SO	MDP0027
EL8401IS-T13*	8401IS	14 Ld SO	MDP0027
EL8401ISZ (See Note)	8401ISZ	14 Ld SO (Pb-free)	MDP0027
EL8401ISZ-T7* (See Note)	8401ISZ	14 Ld SO (Pb-free)	MDP0027
EL8401ISZ-T13* (See Note)	8401ISZ	14 Ld SO (Pb-free)	MDP0027
EL8401IU	8401IU	16 Ld QSOP	MDP0040
EL8401IU-T7*	8401IU	16 Ld QSOP	MDP0040
EL8401IU-T13*	8401IU	16 Ld QSOP	MDP0040
EL8401IUZ (See Note)	8401IUZ	16 Ld QSOP (Pb-free)	MDP0040
EL8401IUZ-T7* (See Note)	8401IUZ	16 Ld QSOP (Pb-free)	MDP0040
EL8401IUZ-T13* (See Note)	8401IUZ	16 Ld QSOP (Pb-free)	MDP0040

*Please refer to TB347 for details on reel specifications.

NOTE: These Intersil Pb-free plastic packaged products employ special Pb-free material sets; molding compounds/die attach materials and 100% matte tin plate PLUS ANNEAL - e3 termination finish, which is RoHS compliant and compatible with both SnPb and Pb-free soldering operations. Intersil Pb-free products are MSL classified at Pb-free peak reflow temperatures that meet or exceed the Pb-free requirements of IPC/JEDEC J STD-020.

EL8200, EL8201, EL8401

Absolute Maximum Ratings ($T_A = 25^\circ\text{C}$)

Supply Voltage from V_{S+} to V_{S-} 5.5V	Power Dissipation See Curves
Input Voltage $V_{S+} + 0.3\text{V}$ to $V_{S-} - 0.3\text{V}$	Storage Temperature -65°C to $+150^\circ\text{C}$
Differential Input Voltage $.2\text{V}$	Ambient Operating Temperature -40°C to $+85^\circ\text{C}$
Continuous Output Current 40mA	Operating Junction Temperature $+125^\circ\text{C}$

CAUTION: Do not operate at or near the maximum ratings listed for extended periods of time. Exposure to such conditions may adversely impact product reliability and result in failures not covered by warranty.

IMPORTANT NOTE: All parameters having Min/Max specifications are guaranteed. Typ values are for information purposes only. Unless otherwise noted, all tests are at the specified temperature and are pulsed tests, therefore: $T_J = T_C = T_A$

Electrical Specifications $V_{S+} = 5\text{V}$, $V_{S-} = \text{GND}$, $T_A = 25^\circ\text{C}$, $V_{CM} = 2.5\text{V}$, R_L to 2.5V, $A_V = 1$, Unless Otherwise Specified

PARAMETER	DESCRIPTION	CONDITIONS	MIN (Note 1)	TYP	MAX (Note 1)	UNIT
INPUT CHARACTERISTICS						
V_{OS}	Offset Voltage		-6	-0.8	+6	mV
TCV_{OS}	Offset Voltage Temperature Coefficient	Measured from T_{MIN} to T_{MAX}		3		$\mu\text{V}/^\circ\text{C}$
I_B	Input Bias Current	$V_{IN} = 0\text{V}$	-2.5	-1.6		μA
I_{OS}	Input Offset Current	$V_{IN} = 0\text{V}$		0.2	0.55	μA
TCI_{OS}	Input Bias Current Temperature Coefficient	Measured from T_{MIN} to T_{MAX}		2		$\text{nA}/^\circ\text{C}$
$CMRR$	Common Mode Rejection Ratio	$V_{CM} = -0.15\text{V}$ to $+3.5\text{V}$ (EL8200, EL8201)	70	90		dB
		$V_{CM} = -0.15\text{V}$ to $+3.5\text{V}$ (EL8401)	65	90		dB
$CMIR$	Common Mode Input Range		$V_{S-} - 0.15$		$V_{S+} - 1.5$	V
R_{IN}	Input Resistance	Common Mode		16		$\text{M}\Omega$
C_{IN}	Input Capacitance			0.5		pF
A_{VOL}	Open Loop Gain	$V_{OUT} = +1.5\text{V}$ to $+3.5\text{V}$, $R_L = 1\text{k}\Omega$ to GND	75	90		dB
		$V_{OUT} = +1.5\text{V}$ to $+3.5\text{V}$, $R_L = 150\Omega$ to GND		80		dB
OUTPUT CHARACTERISTICS						
R_{OUT}	Output Resistance	$A_V = +1$		30		$\text{m}\Omega$
V_{OP}	Positive Output Voltage Swing	$R_L = 1\text{k}\Omega$	4.85	4.9		V
		$R_L = 150\Omega$	4.6	4.7		V
V_{ON}	Negative Output Voltage Swing	$R_L = 150\Omega$		100	150	mV
		$R_L = 1\text{k}\Omega$		35	50	mV
I_{OUT}	Linear Output Current			65		mA
$I_{SC}(\text{source})$	Short Circuit Current	$R_L = 10\Omega$	60	70		mA
$I_{SC}(\text{sink})$	Short Circuit Current	$R_L = 10\Omega$	100	130		mA
POWER SUPPLY						
$PSRR$	Power Supply Rejection Ratio	$V_{S+} = 4.5\text{V}$ to 5.5V	70	100		dB
I_{S-ON}	Supply Current			2	2.4	mA
I_{S-OFF}	Supply Current - Disabled per Amplifier	EL8200 only		40	90	μA
ENABLE (EL8200 ONLY)						
t_{EN}	Enable Time			200		ns
t_{DS}	Disable Time			25		ns
V_{IH-ENB}	ENABLE Pin Voltage for Power-up			0.8		V

EL8200, EL8201, EL8401

Electrical Specifications $V_{S+} = 5V$, $V_{S-} = GND$, $T_A = 25^\circ C$, $V_{CM} = 2.5V$, R_L to 2.5V, $A_V = 1$, Unless Otherwise Specified (Continued)

PARAMETER	DESCRIPTION	CONDITIONS	MIN (Note 1)	TYP	MAX (Note 1)	UNIT
V_{IL-ENB}	\overline{ENABLE} Pin Voltage for Shut-down			2		V
I_{IH-ENB}	\overline{ENABLE} Pin Input Current High			8.6		μA
I_{IL-ENB}	\overline{ENABLE} Pin Input for Current Low			0.01		μA
AC PERFORMANCE						
BW	-3dB Bandwidth	$A_V = +1$, $R_F = 0\Omega$, $C_L = 1.5pF$		200		MHz
		$A_V = -1$, $R_F = 1k\Omega$, $C_L = 1.5pF$		90		MHz
		$A_V = +2$, $R_F = 1k\Omega$, $C_L = 1.5pF$		90		MHz
		$A_V = +10$, $R_F = 1k\Omega$, $C_L = 1.5pF$		10		MHz
BW	$\pm 0.1dB$ Bandwidth	$A_V = +1$, $R_F = 0\Omega$, $C_L = 1.5pF$		20		MHz
Peak	Peaking	$A_V = +1$, $R_F = 1k\Omega$, $C_L = 1.5pF$		1		dB
GBWP	Gain Bandwidth Product			100		MHz
PM	Phase Margin	$R_L = 1k\Omega$, $C_L = 1.5pF$		55		$^\circ$
SR	Slew Rate	$A_V = 2$, $R_L = 100\Omega$, $V_{OUT} = 0.5V$ to 4.5V	160	200		V/ μs
t_R	Rise Time	$2.5V_{STEP}$, 20% - 80%		8		ns
t_F	Fall Time	$2.5V_{STEP}$, 20% - 80%		7		ns
OS	Overshoot	200mV step		10		%
t_{PD}	Propagation Delay	200mV step		2		ns
t_S	0.1% Settling Time	200mV step		20		ns
dG	Differential Gain	$A_V = +2$, $R_F = 1k\Omega$, $R_L = 150\Omega$		0.035		%
dP	Differential Phase	$A_V = +2$, $R_F = 1k\Omega$, $R_L = 150\Omega$		0.05		$^\circ$
e_N	Input Noise Voltage	$f = 10kHz$		10		nV/ \sqrt{Hz}
i_{N+}	Positive Input Noise Current	$f = 10kHz$		1		pA/ \sqrt{Hz}
i_{N-}	Negative Input Noise Current	$f = 10kHz$		0.8		pA/ \sqrt{Hz}
e_S	Channel Separation	$f = 100kHz$		95		dB

NOTE:

1. Parts are 100% tested at +25°C. Over-temperature limits established by characterization and are not production tested.

Pin Descriptions

EL8200 (10 Ld SO)	EL8201 (8 Ld SO, 8 Ld MSOP)	EL8401 (14 Ld SO)	EL8401 (16 Ld QSOP)	NAME	FUNCTION
1, 5	3, 5	3, 5, 10, 12	3, 5, 12, 14	IN+	Non-inverting input for each channel
2, 4				\overline{CE}	Enable and disable input for each channel
3	4	11	13	VS-	Negative power supply
6, 10	2, 6	2, 6, 9, 13	2, 6, 11, 15	IN-	Inverting input for each channel
7, 9	1, 7	1, 7, 8, 14	1, 7, 10, 16	OUT	Amplifier output for each channel
8	8	4	4	VS+	Positive power supply

Typical Performance Curves

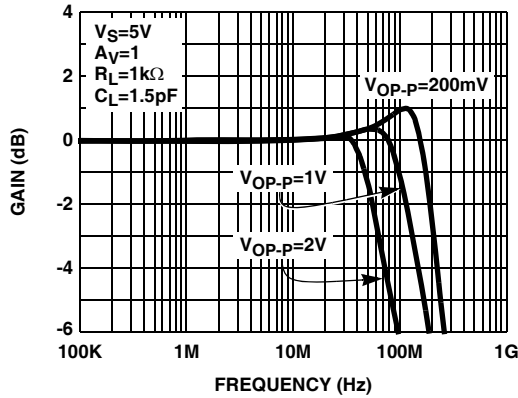

FIGURE 1. FREQUENCY RESPONSE FOR VARIOUS OUTPUT VOLTAGE LEVELS

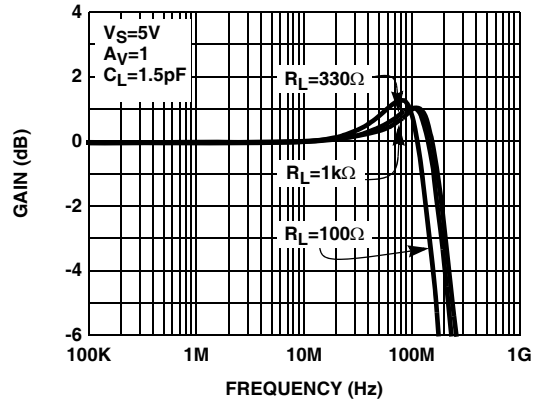

FIGURE 2. SMALL SIGNAL FREQUENCY RESPONSE FOR VARIOUS R_{LOAD}

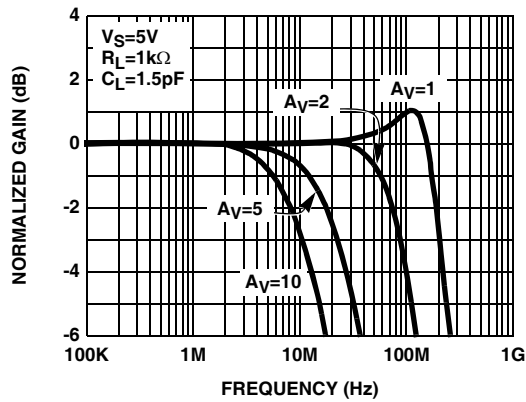

FIGURE 3. SMALL SIGNAL FREQUENCY RESPONSE FOR VARIOUS NON-INVERTING GAINS

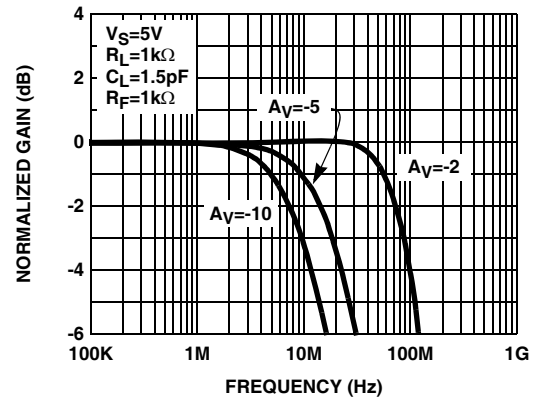

FIGURE 4. SMALL SIGNAL FREQUENCY RESPONSE FOR VARIOUS INVERTING GAINS

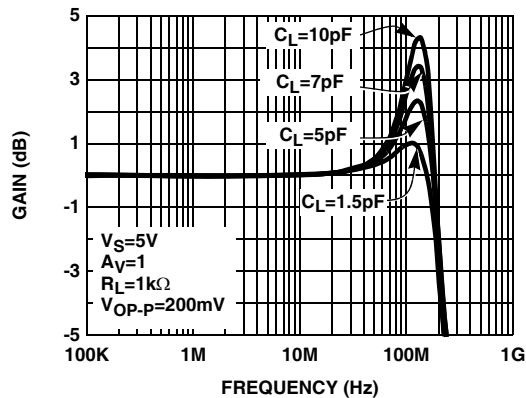

FIGURE 5. SMALL SIGNAL FREQUENCY RESPONSE FOR VARIOUS C_L

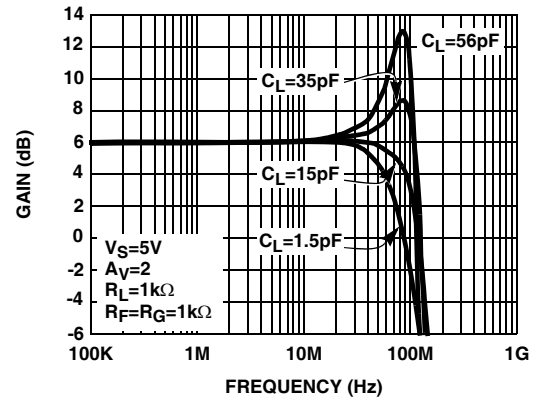

FIGURE 6. SMALL SIGNAL FREQUENCY RESPONSE FOR VARIOUS C_L

Typical Performance Curves (Continued)

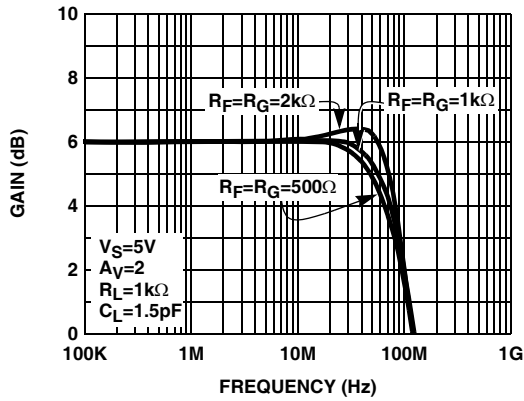

FIGURE 7. SMALL SIGNAL FREQUENCY RESPONSE FOR VARIOUS R_F AND R_G

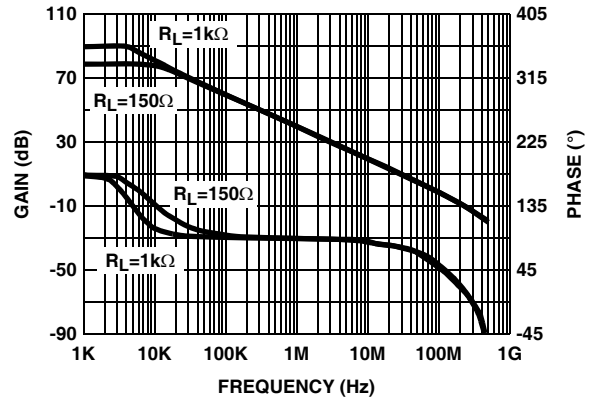

FIGURE 8. OPEN LOOP GAIN AND PHASE vs FREQUENCY

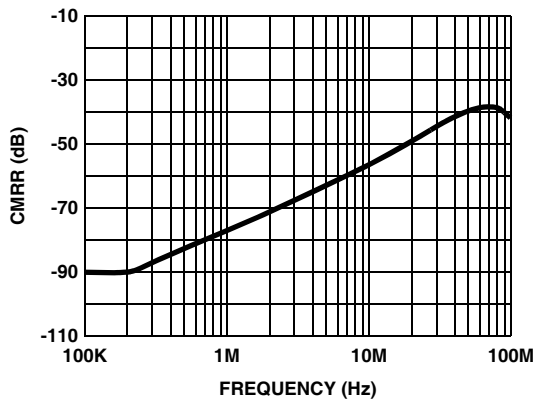

FIGURE 9. COMMON-MODE REJECTION RATIO vs FREQUENCY

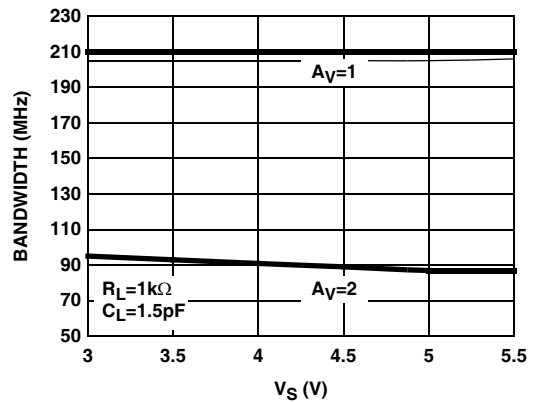

FIGURE 10. SMALL SIGNAL BANDWIDTH vs SUPPLY VOLTAGE

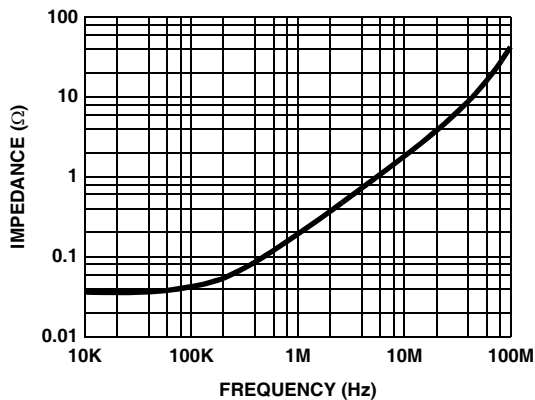

FIGURE 11. OUTPUT IMPEDANCE vs FREQUENCY

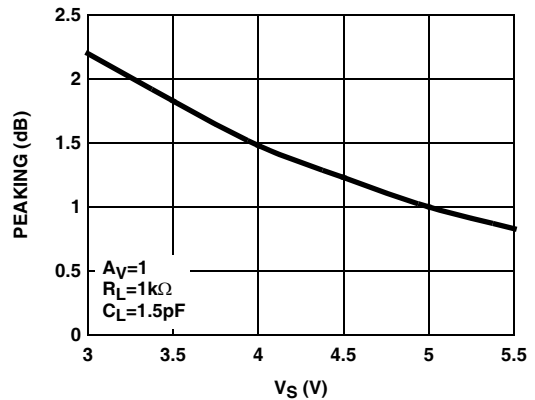

FIGURE 12. SMALL SIGNAL PEAKING vs SUPPLY VOLTAGE

Typical Performance Curves (Continued)

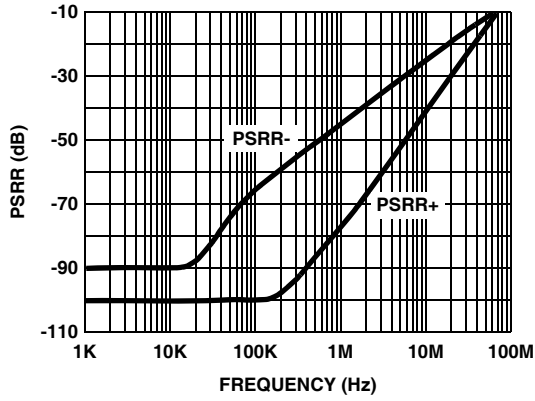

FIGURE 13. POWER SUPPLY REJECTION RATIO vs FREQUENCY

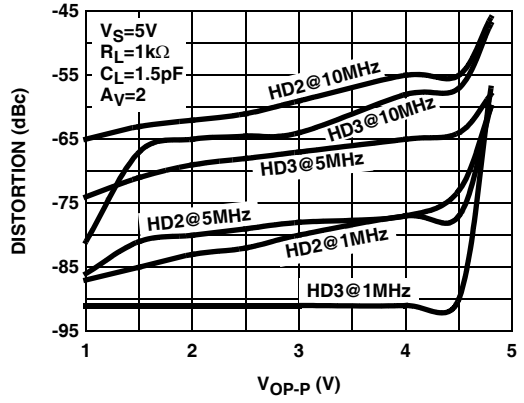

FIGURE 14. HARMONIC DISTORTION vs OUTPUT VOLTAGE

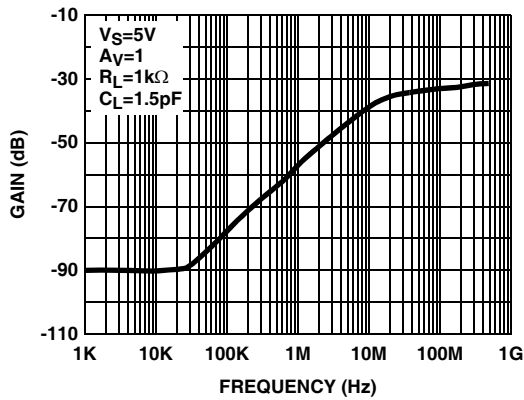

FIGURE 15. DISABLED OUTPUT ISOLATION FREQUENCY RESPONSE

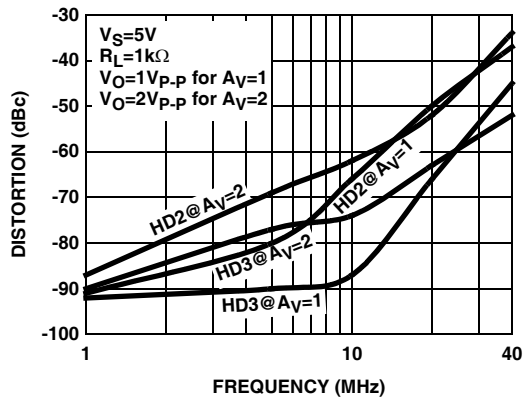

FIGURE 16. HARMONIC DISTORTION vs FREQUENCY

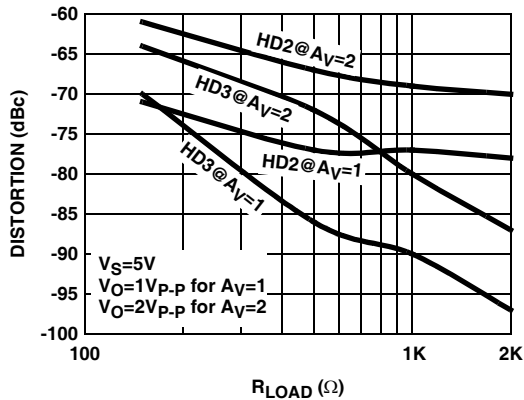

FIGURE 17. HARMONIC DISTORTION vs LOAD RESISTANCE

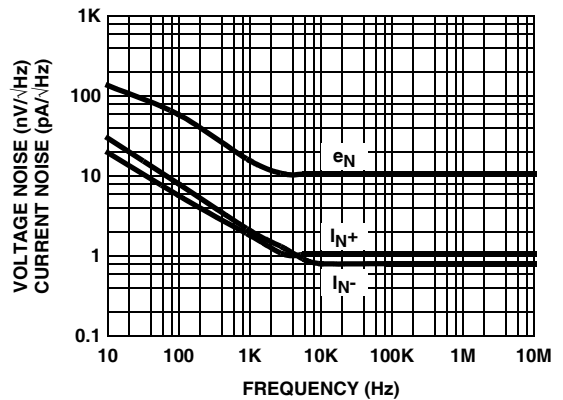

FIGURE 18. VOLTAGE AND CURRENT NOISE vs FREQUENCY

Typical Performance Curves (Continued)

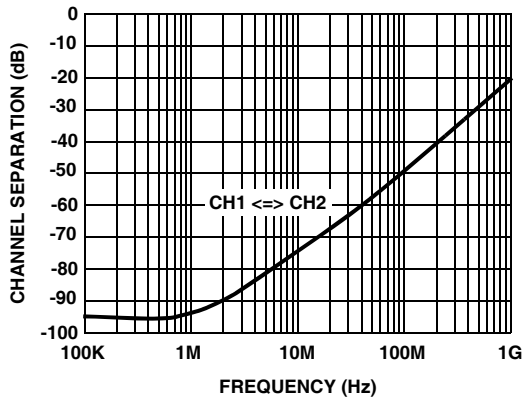

FIGURE 19. CHANNEL SEPARATION vs FREQUENCY (EL8200 AND EL8201)

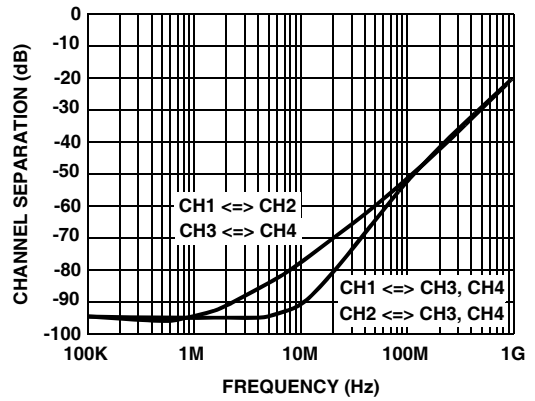

FIGURE 20. CHANNEL SEPARATION vs FREQUENCY (EL8401)

$V_S=5V, A_V=1, R_L=1k\Omega$ to 2.5V

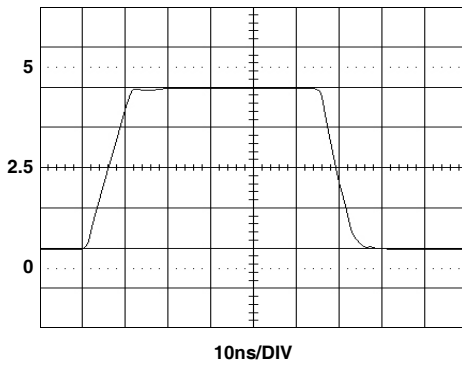

FIGURE 21. LARGE SIGNAL TRANSIENT RESPONSE

$V_S=5V, A_V=5, R_L=1k\Omega$ to 2.5V

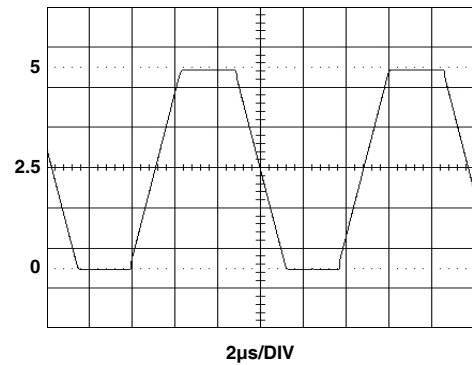

FIGURE 22. OUTPUT SWING

$V_S=5V, A_V=1, R_L=1k\Omega$ to 2.5V $C_L=1.5pF$

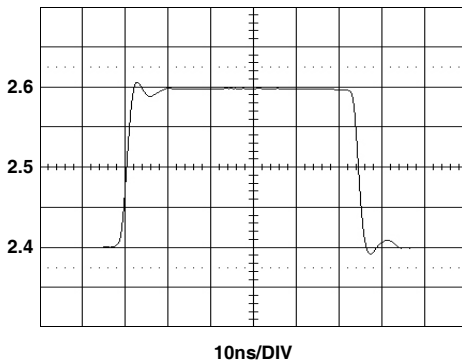

FIGURE 23. SMALL SIGNAL TRANSIENT RESPONSE

$V_S=5V, A_V=5, R_L=1k\Omega$ to 2.5V

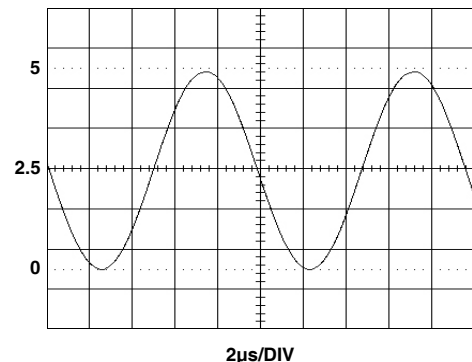

FIGURE 24. OUTPUT SWING

EL8200, EL8201, EL8401

Typical Performance Curves (Continued)

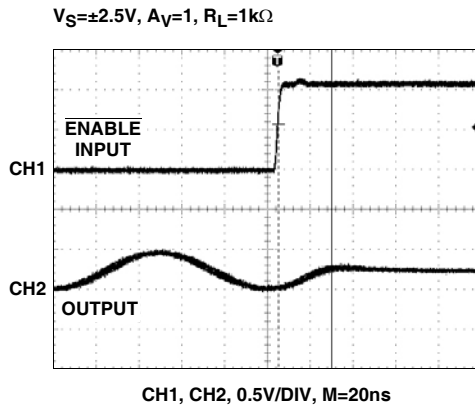

FIGURE 25. DISABLED RESPONSE (EL8200)

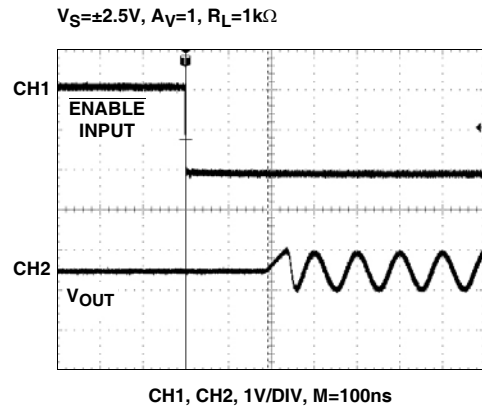

FIGURE 26. ENABLED RESPONSE (EL8200)

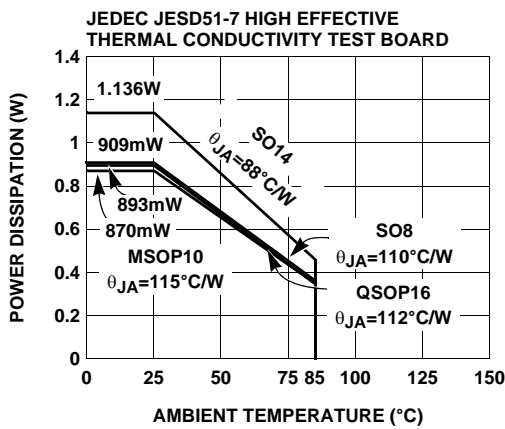

FIGURE 27. PACKAGE POWER DISSIPATION vs AMBIENT TEMPERATURE

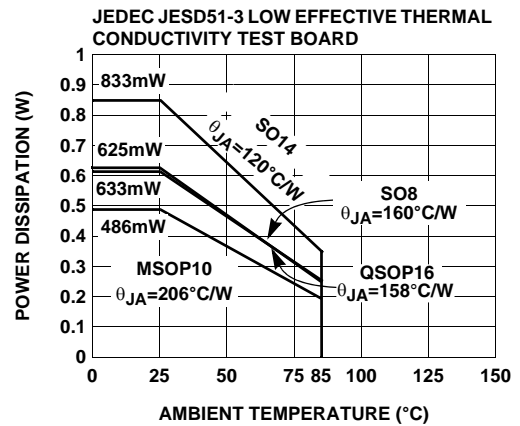
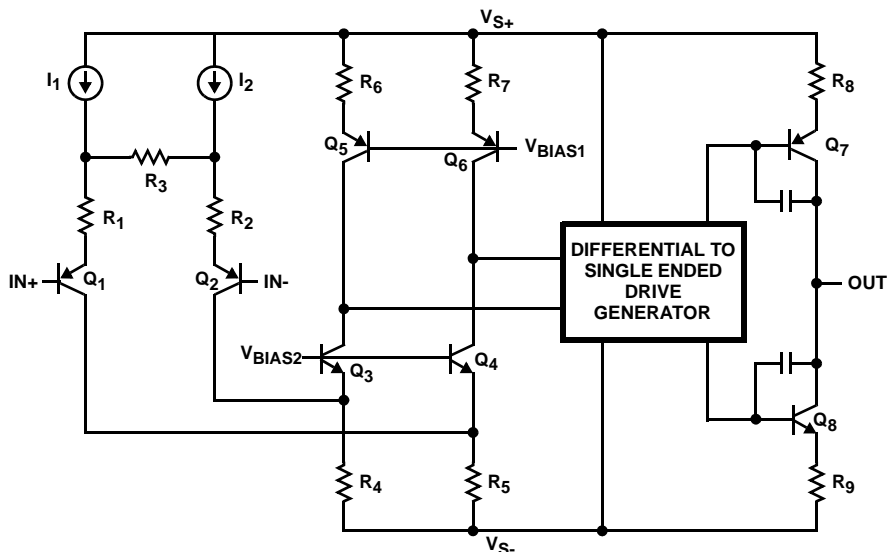

FIGURE 28. PACKAGE POWER DISSIPATION vs AMBIENT TEMPERATURE

Simplified Schematic Diagram



EL8200, EL8201, EL8401

Description of Operation and Application Information

Product Description

The EL8200, EL8201 and EL8401 are wide bandwidth, single supply, low power and rail-to-rail output voltage feedback operational amplifiers. The amplifiers are internally compensated for closed loop gain of +1 or greater. Connected in voltage follower mode and driving a 1k Ω load, they have a -3dB bandwidth of 200MHz. Driving a 150 Ω load, the bandwidth is about 130MHz while maintaining a 200V/us slew rate. The EL8200 is available with a power down pin to reduce power to 30 μ A typically while the amplifier is disabled.

Input, Output and Supply Voltage Range

The EL8200, EL8201 and EL8401 have been designed to operate with a single supply voltage from 3V to 5.0V. Split supplies can also be used as long as their total voltage is within 3V to 5.0V. The amplifiers have an input common mode voltage range from 0.15V below the negative supply (V_{S-} pin) to within 1.5V of the positive supply (V_{S+} pin). If the input signal is outside the above specified range, it will cause the output signal to be distorted.

The output of the EL8200, EL8201 and EL8401 can swing rail to rail. As the load resistance becomes lower, the ability to drive close to each rail is reduced. For the load resistor 1k Ω , the output swing is about 4.9V at a 5V supply. For the load resistor 150 Ω , the output swing is about 4.6V.

Choice of Feedback Resistor and Gain Bandwidth Product

For applications that require a gain of +1, no feedback resistor is required. Just short the output pin to the inverting input pin. For gains greater than +1, the feedback resistor forms a pole with the parasitic capacitance at the inverting input. As this pole becomes smaller, the amplifier's phase margin is reduced. This causes ringing in the time domain and peaking in the frequency domain. Therefore, R_F has some maximum value that should not be exceeded for optimum performance. If a large value of R_F must be used, a small capacitor in the few Pico farad range in parallel with R_F can help to reduce the ringing and peaking at the expense of reducing the bandwidth.

As far as the output stage of the amplifier is concerned, the output stage is also a gain stage with the load. R_F and R_G appear in parallel with R_L for gains other than +1. As this combination gets smaller, the bandwidth falls off. Consequently, R_F also has a minimum value that should not be exceeded for optimum performance. For gain of +1, $R_F=0$ is optimum. For the gains other than +1, optimum response is obtained with R_F between 300 Ω to 1k Ω .

The EL8200, EL8201 and EL8401 have a gain bandwidth product of 100MHz. For gains ≥ 5 , its bandwidth can be predicted by the following equation:

$$\text{Gain} \times \text{BW} = 100\text{MHz}$$

Video Performance

For good video performance, an amplifier is required to maintain the same output impedance and the same frequency response as DC levels are changed at the output. This is especially difficult when driving a standard video load of 150 Ω , because the change in output current with DC level. Special circuitry has been incorporated in the EL8200, EL8201 and EL8401 to reduce the variation of the output impedance with the current output. This results in dG and dP specifications of 0.03% and 0.05%, while driving 150 Ω at a gain of 2. Driving high impedance loads would give a similar or better dG and dP performance.

Driving Capacitive Loads and Cables

The EL8200, EL8201 and EL8401 can drive 10pF loads in parallel with 1k Ω with less than 5dB of peaking at gain of +1. If less peaking is desired in applications, a small series resistor (usually between 5 Ω to 50 Ω) can be placed in series with the output to eliminate most peaking. However, this will reduce the gain slightly. If the gain setting is greater than 1, the gain resistor R_G can then be chosen to make up for any gain loss which may be created by the additional series resistor at the output.

When used as a cable driver, double termination is always recommended for reflection-free performance. For those applications, a back-termination series resistor at the amplifier's output will isolate the amplifier from the cable and allow extensive capacitive drive. However, other applications may have high capacitive loads without a back-termination resistor. Again, a small series resistor at the output can help to reduce peaking.

Disable/Power-Down

The EL8200 can be disabled and placed its output in a high impedance state. The turn off time for each channel is about 25ns and the turn on time is about 200ns. When disabled, the amplifier's supply current is reduced to 30 μ A typically, thereby effectively eliminating the power consumption. The amplifier's power down can be controlled by standard TTL or CMOS signal levels at the $\overline{\text{ENABLE}}$ pin. The applied logic signal is relative to V_{S-} pin. Letting the $\overline{\text{ENABLE}}$ pin float or applying a signal that is less than 0.8V above V_{S-} will enable the amplifier. The amplifier will be disabled when the signal at $\overline{\text{ENABLE}}$ pin is 2V above V_{S-} .

Output Drive Capability

The EL8200, EL8201 and EL8401 do not have internal short circuit protection circuitry. They have a typical short circuit current of 70mA sourcing and 140mA sinking for the output is connected to half way between the rails with a 10 Ω resistor. If the output is shorted indefinitely, the power

EL8200, EL8201, EL8401

dissipation could easily increase such that the part will be destroyed. Maximum reliability is maintained if the output current never exceeds $\pm 40\text{mA}$. This limit is set by the design of the internal metal interconnections.

Power Dissipation

With the high output drive capability of the EL8200, EL8201 and EL8401, it is possible to exceed the 125°C absolute maximum junction temperature under certain load current conditions. Therefore, it is important to calculate the maximum junction temperature for the application to determine if the load conditions or package types need to be modified for the amplifier to remain in the safe operating area.

The maximum power dissipation allowed in a package is determined according to:

$$PD_{MAX} = \frac{T_{JMAX} - T_{AMAX}}{\theta_{JA}}$$

Where:

T_{JMAX} = Maximum junction temperature

T_{AMAX} = Maximum ambient temperature

θ_{JA} = Thermal resistance of the package

The maximum power dissipation actually produced by an IC is the total quiescent supply current times the total power supply voltage, plus the power in the IC due to the load, or:

For sourcing:

$$PD_{MAX} = V_S \times I_{SMAX} + \Sigma(V_S - V_{OUTi}) \times \frac{V_{OUTi}}{R_{Li}}$$

For sinking:

$$PD_{MAX} = V_S \times I_{SMAX} + \Sigma(V_{OUTi} - V_{S-}) \times I_{LOADi}$$

Where:

V_S = Total supply voltage

I_{SMAX} = Maximum quiescent supply current

V_{OUTi} = Maximum output voltage of the application for each channel

R_{LOADi} = Load resistance tied to ground for each channel

I_{LOADi} = Load current for each channel

By setting the two PD_{MAX} equations equal to each other, we can solve the output current and R_{LOADi} to avoid the device overheat.

Power Supply Bypassing and Printed Circuit Board Layout

As with any high frequency device, a good printed circuit board layout is necessary for optimum performance. Lead lengths should be as short as possible. The power supply pin must be well bypassed to reduce the risk of oscillation. For

normal single supply operation, where the V_{S-} pin is connected to the ground plane, a single $4.7\mu\text{F}$ tantalum capacitor in parallel with a $0.1\mu\text{F}$ ceramic capacitor from V_{S+} to GND will suffice. This same capacitor combination should be placed at each supply pin to ground if split supplies are to be used. In this case, the V_{S-} pin becomes the negative supply rail.

For good AC performance, parasitic capacitance should be kept to a minimum. Use of wire wound resistors should be avoided because of their additional series inductance. Use of sockets should also be avoided if possible. Sockets add parasitic inductance and capacitance that can result in compromised performance. Minimizing parasitic capacitance at the amplifier's inverting input pin is very important. The feedback resistor should be placed very close to the inverting input pin. Strip line design techniques are recommended for the signal traces.

Typical Applications

VIDEO SYNC PULSE REMOVER

Many CMOS analog to digital converters have a parasitic latch up problem when subjected to negative input voltage levels. Since the sync tip contains no useful video information and it is a negative going pulse, we can chop it off. Figure 29 shows a gain of 2 connections. Figure 30 shows the complete input video signal applied at the input, as well as the output signal with the negative going sync pulse removed.

MULTIPLEXER

Besides the normal power down usage, the $\overline{\text{ENABLE}}$ pin of the EL8200 can be used for multiplexing applications. Figure 31 shows two channels with the outputs tied together, driving a back terminated 75Ω video load. A $2V_{P-P}$ 2MHz sine wave is applied to Amp A and a $1V_{P-P}$ 2MHz sine wave is applied to Amp B. Figure 32 shows the $\overline{\text{ENABLE}}$ signal and the resulting output waveform at V_{OUT} . Observe the break-before-make operation of the multiplexing. Amp A is on and V_{IN1} is passed through to the output when the $\overline{\text{ENABLE}}$ signal is low and turns off in about 25ns when the $\overline{\text{ENABLE}}$ signal is high. About 200ns later, Amp B turns on and V_{IN2} is passed through to the output. The break-before-make operation ensures that more than one amplifier isn't trying to drive the bus at the same time.

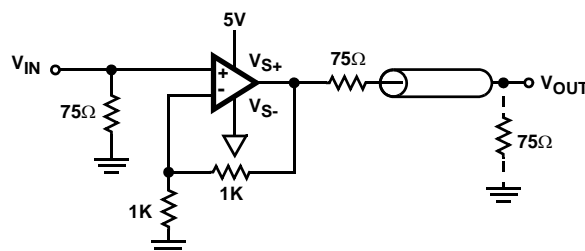

FIGURE 29. SYNC PULSE REMOVER

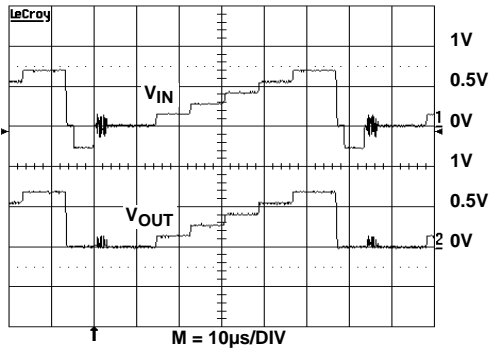

FIGURE 30. VIDEO SIGNAL

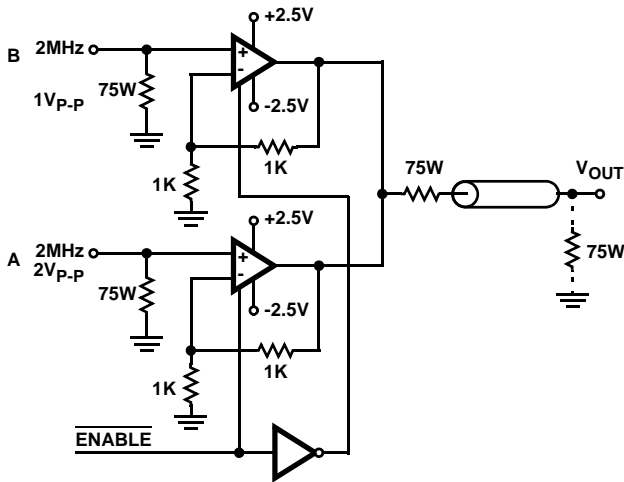

FIGURE 31. TWO TO ONE MULTIPLEXER

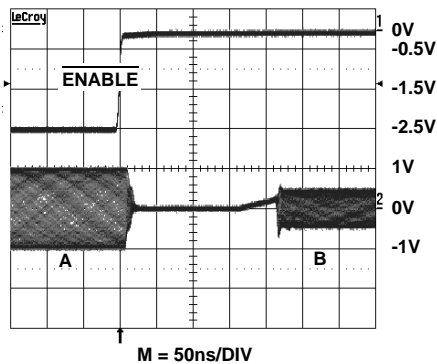

FIGURE 32. ENABLE SIGNAL

SINGLE SUPPLY VIDEO LINE DRIVER

The EL8200, EL8201 and EL8401 are wideband rail-to-rail output op amplifiers with large output current, excellent dG, dP, and low distortion that allow them to drive video signals in low supply applications. Figure 33 is the single supply non-inverting video line driver configuration and Figure 34 is the inverting video line driver configuration. The signal is AC coupled by C_1 . R_1 and R_2 are used to level shift the input and output to provide the largest output swing. R_F and R_G

set the AC gain. C_2 isolates the virtual ground potential. R_T and R_3 are the termination resistors for the line. C_1 , C_2 and C_3 are selected big enough to minimize the droop of the luminance signal.

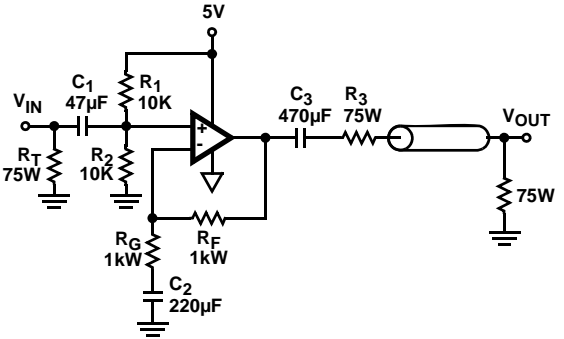

FIGURE 33. 5V SINGLE SUPPLY NON INVERTING VIDEO LINE DRIVER

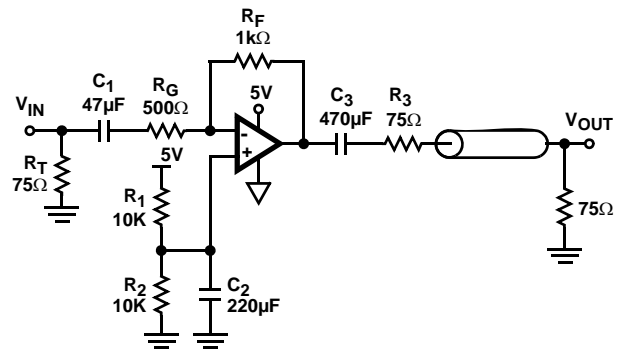

FIGURE 34. 5V SINGLE SUPPLY INVERTING VIDEO LINE DRIVER

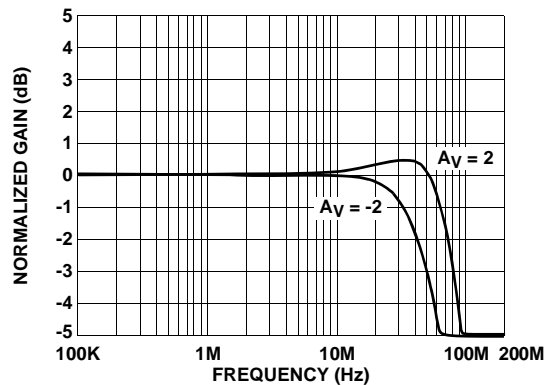
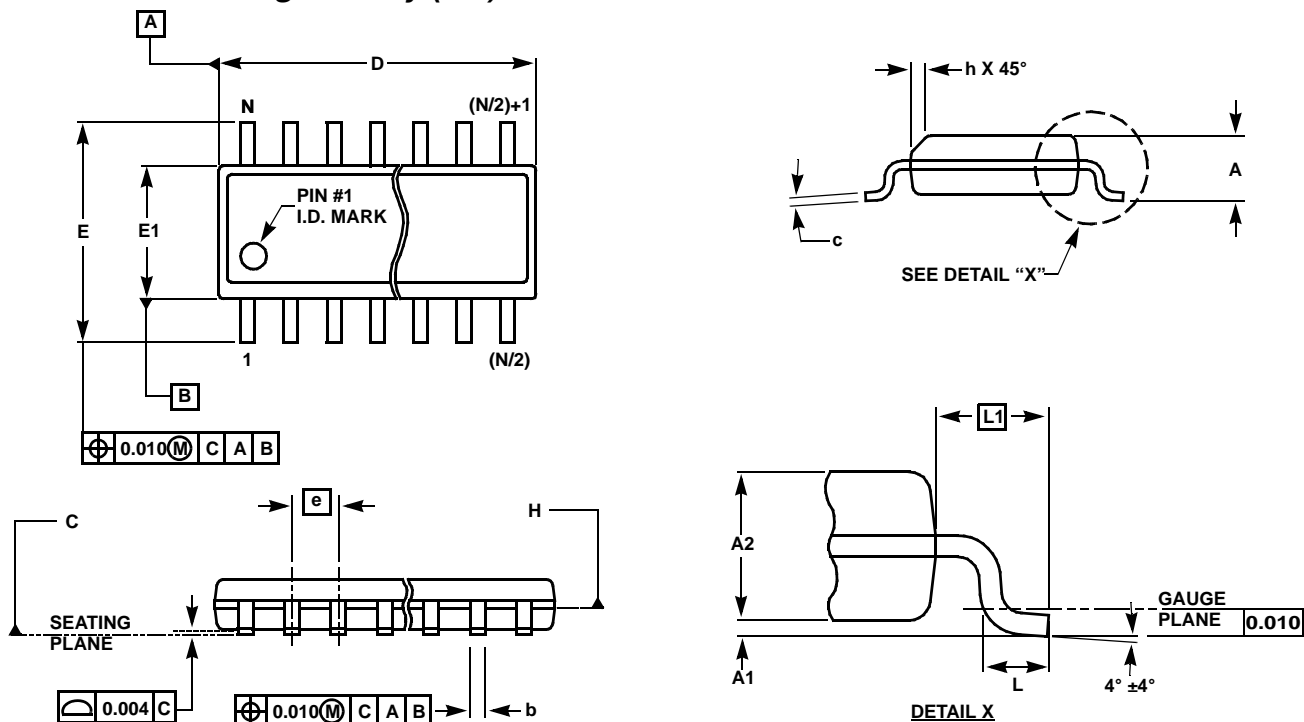

FIGURE 35. VIDEO LINE DRIVER FREQUENCY RESPONSE

EL8200, EL8201, EL8401

Small Outline Package Family (SO)



MDP0027

SMALL OUTLINE PACKAGE FAMILY (SO)

SYMBOL	INCHES							TOLERANCE	NOTES
	SO-8	SO-14	SO16 (0.150")	SO16 (0.300") (SOL-16)	SO20 (SOL-20)	SO24 (SOL-24)	SO28 (SOL-28)		
A	0.068	0.068	0.068	0.104	0.104	0.104	0.104	MAX	-
A1	0.006	0.006	0.006	0.007	0.007	0.007	0.007	±0.003	-
A2	0.057	0.057	0.057	0.092	0.092	0.092	0.092	±0.002	-
b	0.017	0.017	0.017	0.017	0.017	0.017	0.017	±0.003	-
c	0.009	0.009	0.009	0.011	0.011	0.011	0.011	±0.001	-
D	0.193	0.341	0.390	0.406	0.504	0.606	0.704	±0.004	1, 3
E	0.236	0.236	0.236	0.406	0.406	0.406	0.406	±0.008	-
E1	0.154	0.154	0.154	0.295	0.295	0.295	0.295	±0.004	2, 3
e	0.050	0.050	0.050	0.050	0.050	0.050	0.050	Basic	-
L	0.025	0.025	0.025	0.030	0.030	0.030	0.030	±0.009	-
L1	0.041	0.041	0.041	0.056	0.056	0.056	0.056	Basic	-
h	0.013	0.013	0.013	0.020	0.020	0.020	0.020	Reference	-
N	8	14	16	16	20	24	28	Reference	-

Rev. M 2/07

NOTES:

1. Plastic or metal protrusions of 0.006" maximum per side are not included.
2. Plastic interlead protrusions of 0.010" maximum per side are not included.
3. Dimensions "D" and "E1" are measured at Datum Plane "H".
4. Dimensioning and tolerancing per ASME Y14.5M-1994

EL8200, EL8201, EL8401

Quarter Size Outline Plastic Packages Family (QSOP)

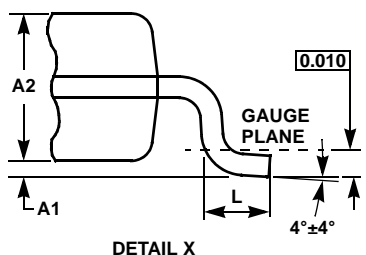
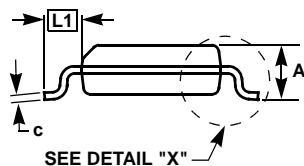
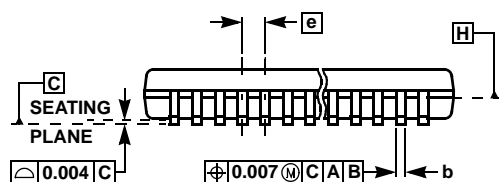
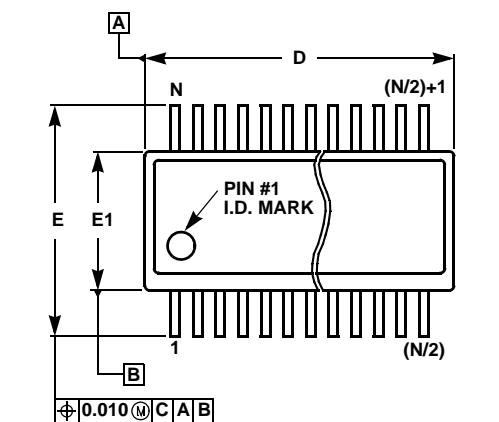

MDP0040

QUARTER SIZE OUTLINE PLASTIC PACKAGES FAMILY

SYMBOL	INCHES			TOLERANCE	NOTES
	QSOP16	QSOP24	QSOP28		
A	0.068	0.068	0.068	Max.	-
A1	0.006	0.006	0.006	±0.002	-
A2	0.056	0.056	0.056	±0.004	-
b	0.010	0.010	0.010	±0.002	-
c	0.008	0.008	0.008	±0.001	-
D	0.193	0.341	0.390	±0.004	1, 3
E	0.236	0.236	0.236	±0.008	-
E1	0.154	0.154	0.154	±0.004	2, 3
e	0.025	0.025	0.025	Basic	-
L	0.025	0.025	0.025	±0.009	-
L1	0.041	0.041	0.041	Basic	-
N	16	24	28	Reference	-

Rev. F 2/07

NOTES:

1. Plastic or metal protrusions of 0.006" maximum per side are not included.
2. Plastic interlead protrusions of 0.010" maximum per side are not included.
3. Dimensions "D" and "E1" are measured at Datum Plane "H".
4. Dimensioning and tolerancing per ASME Y14.5M-1994.

EL8200, EL8201, EL8401

Mini SO Package Family (MSOP)

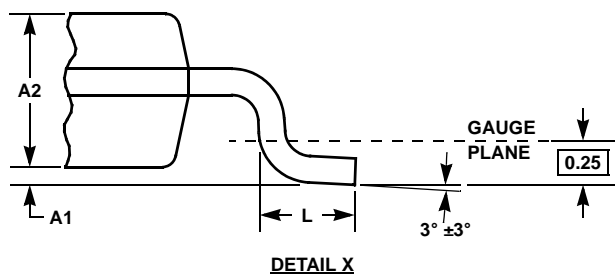
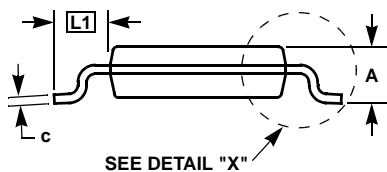
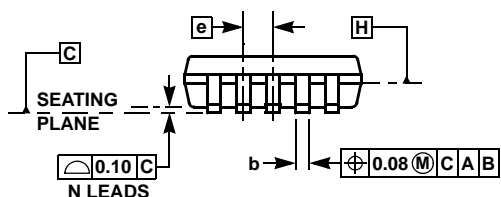
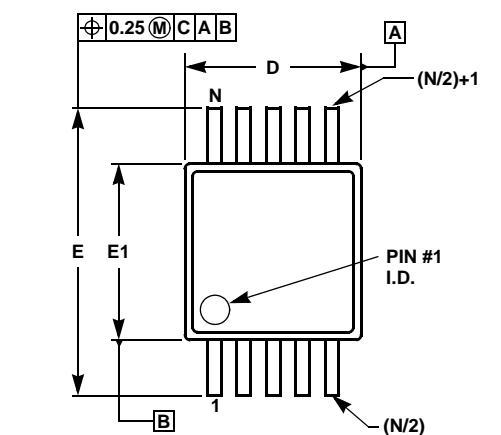

MDP0043

MINI SO PACKAGE FAMILY

SYMBOL	MILLIMETERS		TOLERANCE	NOTES
	MSOP8	MSOP10		
A	1.10	1.10	Max.	-
A1	0.10	0.10	±0.05	-
A2	0.86	0.86	±0.09	-
b	0.33	0.23	+0.07/-0.08	-
c	0.18	0.18	±0.05	-
D	3.00	3.00	±0.10	1, 3
E	4.90	4.90	±0.15	-
E1	3.00	3.00	±0.10	2, 3
e	0.65	0.50	Basic	-
L	0.55	0.55	±0.15	-
L1	0.95	0.95	Basic	-
N	8	10	Reference	-

Rev. D 2/07

NOTES:

1. Plastic or metal protrusions of 0.15mm maximum per side are not included.
2. Plastic interlead protrusions of 0.25mm maximum per side are not included.
3. Dimensions "D" and "E1" are measured at Datum Plane "H".
4. Dimensioning and tolerancing per ASME Y14.5M-1994.

All Intersil U.S. products are manufactured, assembled and tested utilizing ISO9000 quality systems. Intersil Corporation's quality certifications can be viewed at www.intersil.com/design/quality

Intersil products are sold by description only. Intersil Corporation reserves the right to make changes in circuit design, software and/or specifications at any time without notice. Accordingly, the reader is cautioned to verify that data sheets are current before placing orders. Information furnished by Intersil is believed to be accurate and reliable. However, no responsibility is assumed by Intersil or its subsidiaries for its use; nor for any infringements of patents or other rights of third parties which may result from its use. No license is granted by implication or otherwise under any patent or patent rights of Intersil or its subsidiaries.

For information regarding Intersil Corporation and its products, see www.intersil.com