



EMIF04-EAR01F2

4-line IPAD™, EMI filter and ESD protection

Features

- EMI (I/O) low-pass filter
- High efficiency in EMI filtering
- High density capacitor
- Very low PCB space occupation:
1.92 x 1.42 mm²
- Very thin package: 0.65 mm
- High efficiency in ESD suppression on external pins (IEC 61000-4-2 level 4)
- High reliability offered by monolithic integration
- High reduction of parasitic elements through integration and wafer level packaging

Complies with the following standards

- IEC 61000-4-2 Level 4, on output pins
 - 15 kV (air discharge)
- IEC 61000-4-2 Level 1, on input pins
 - 2 kV (air discharge)

Applications

Where EMI filtering in ESD sensitive equipment is required:

- Earpiece and headset for mobile phones
- PDAs
- MP3 players

Description

The **EMIF04-EAR01F2** is a 4-line highly integrated device designed to suppress EMI/RFI noise in all systems subjected to electromagnetic interference. The EMIF04 Flip Chip packaging means the package size is equal to the die size.

This filter includes ESD protection circuitry, which prevents damage to the application when subjected to ESD surges up 15 kV.

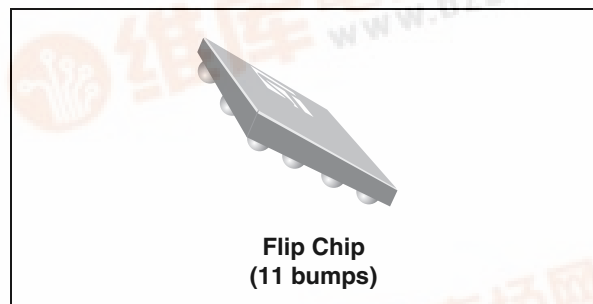

Figure 1. Pin configuration (bump side)

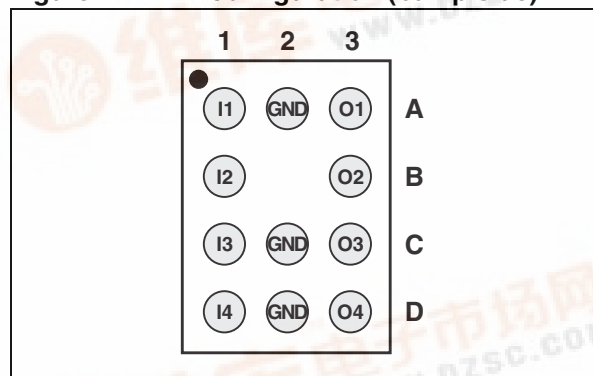
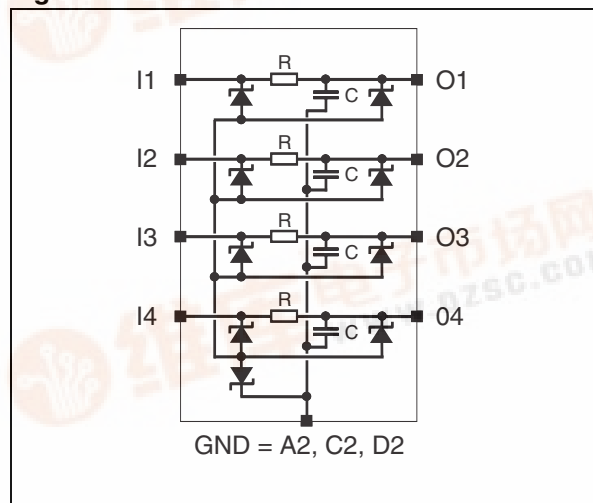

Figure 2. Schematic



TM: IPAD is a trademark of STMicroelectronics.



1 Characteristics

Table 1. Absolute maximum ratings ($T_{amb} = 25\text{ }^{\circ}\text{C}$)

Symbol	Parameter and test conditions	Value	Unit
V_{PP}	Output pins (A3, B3, C3, D3) ESD discharge IEC61000-4-2, air discharge	15	kV
	Input pins (A1, B1, C1, D1) ESD discharge IEC61000-4-2, air discharge	2	
T_j	Maximum junction temperature	125	$^{\circ}\text{C}$
T_{op}	Operating temperature range	- 40 to + 85	$^{\circ}\text{C}$
T_{stg}	Storage temperature range	- 55 to + 150	$^{\circ}\text{C}$

Table 2. Electrical characteristics ($T_{amb} = 25\text{ }^{\circ}\text{C}$)

Symbol	Parameter				
V_{BR}	Breakdown voltage				
I_{RM}	Leakage current @ V_{RM}				
V_{RM}	Stand-off voltage				
V_{CL}	Clamping voltage				
R_d	Dynamic impedance				
I_{PP}	Peak pulse current				
R	Series resistance between input and output				
C	Capacitance				
Symbol	Test conditions	Min.	Typ.	Max.	Unit
V_{BR}	$I_R = 1\text{ mA}$	14		18	V
I_{RM}	$V_{RM} = 3\text{ V per line}$			500	nA
R	Tolerance $\pm 30\%$		10		Ω
C	$V_{LINE} = 0\text{ V}, V_{OSC} = 30\text{ mV}, F = 1\text{ MHz}$ Tolerance $\pm 20\%$		5.8		nF

Figure 3. S21 (db) all lines attenuation

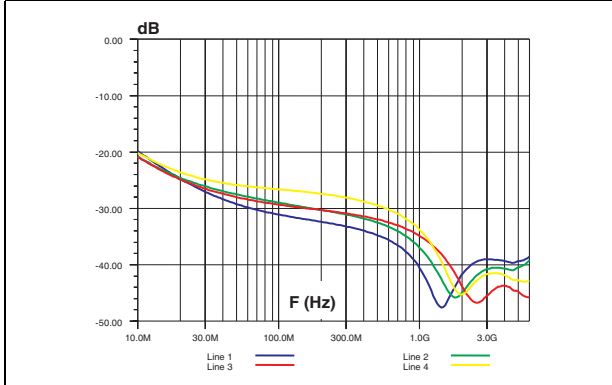

Figure 4. Analog cross talk

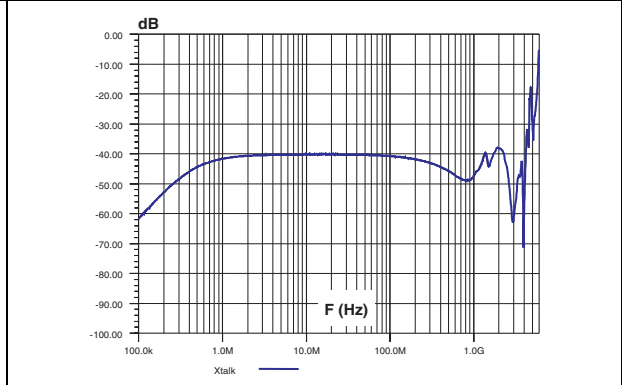

Figure 5. ESD response to IEC 61000-4-2 (+15 kV air discharge) on one output

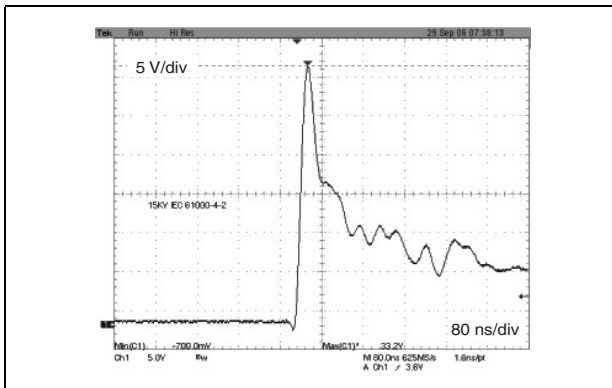

Figure 6. ESD response to IEC 61000-4-2 (-15 kV air discharge) on one output

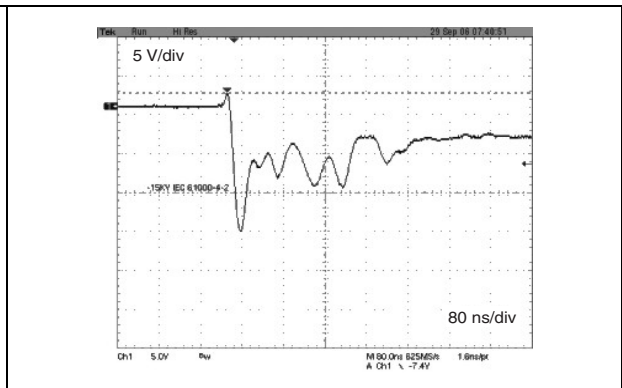
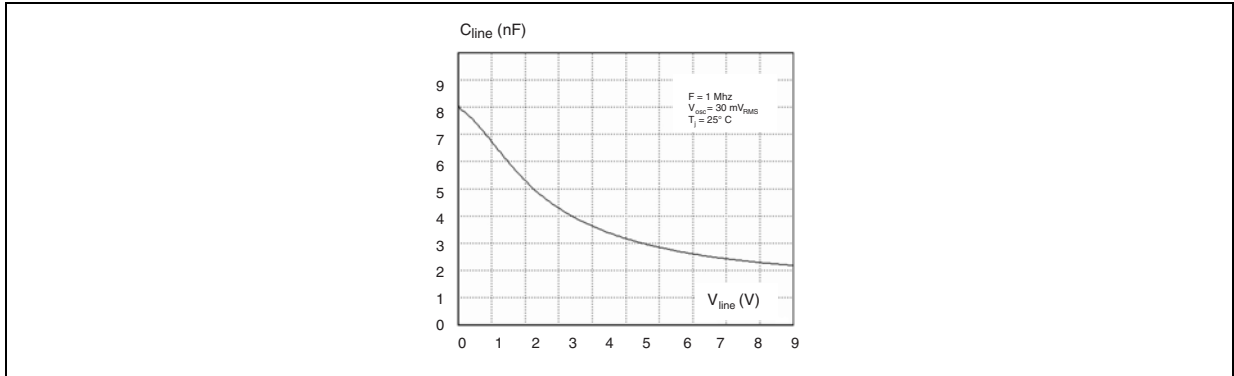
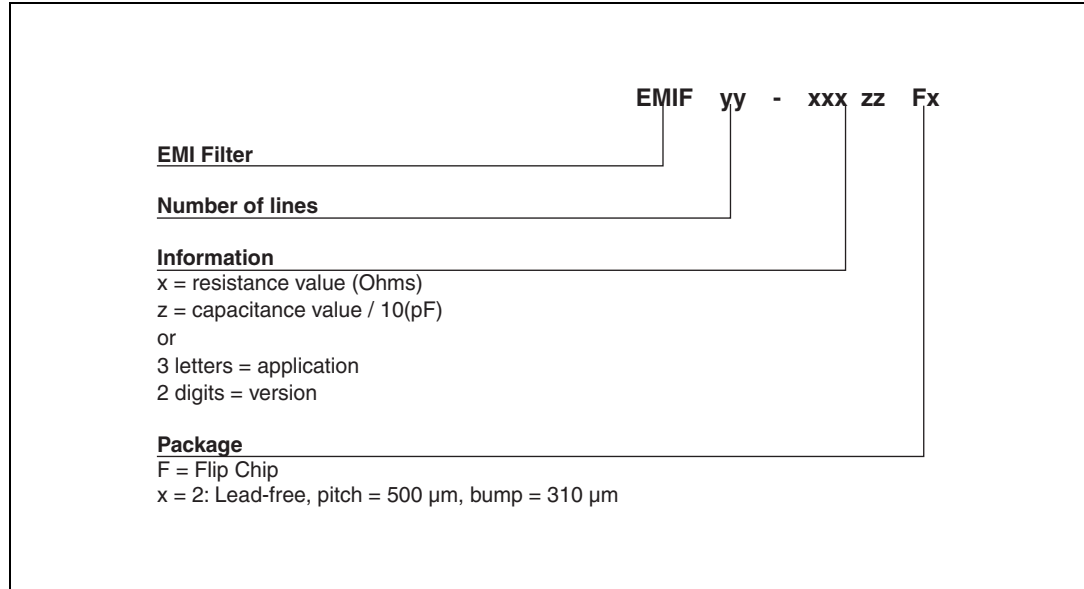

Figure 7. Line capacitance versus reverse applied voltage



2 Ordering information scheme

Figure 8. Ordering information scheme



3 Packaging information

In order to meet environmental requirements, ST offers these devices in ECOPACK[®] packages. These packages have a lead-free second level interconnect. The category of second level interconnect is marked on the inner box label, in compliance with JEDEC Standard JESD97. The maximum ratings related to soldering conditions are also marked on the inner box label. ECOPACK is an ST trademark. ECOPACK specifications are available at www.st.com.

Figure 9. Flip Chip package dimensions

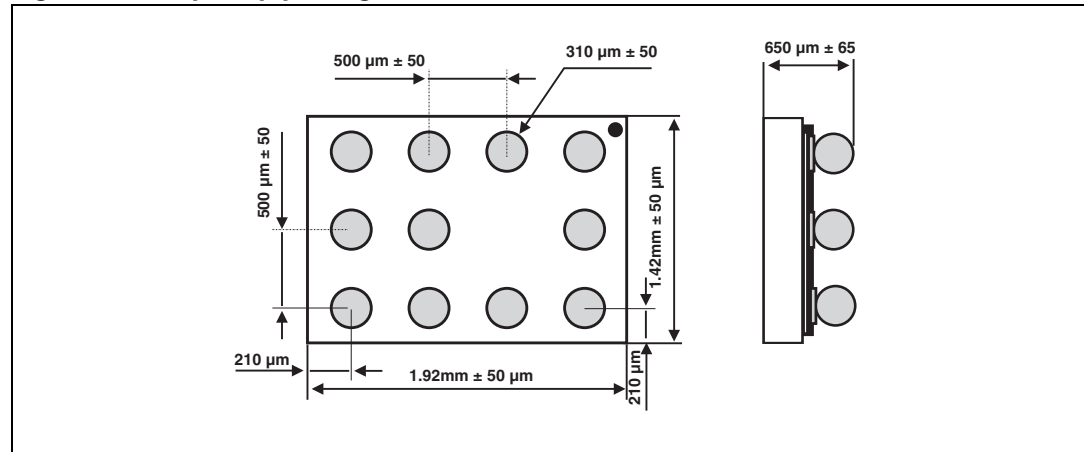

Figure 10. Footprint recommendations

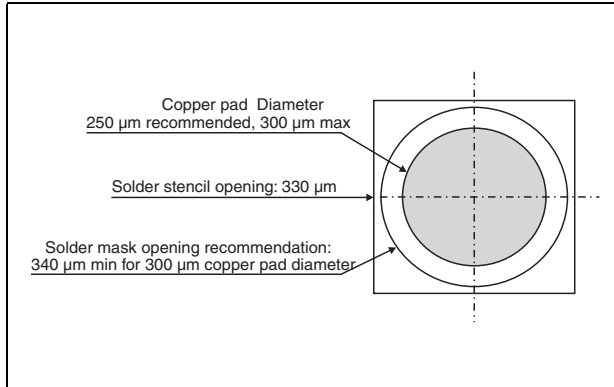

Figure 11. Marking

Dot, ST logo
xx = marking
z = manufacturing location
yww = datecode
(Y = year
ww = week)

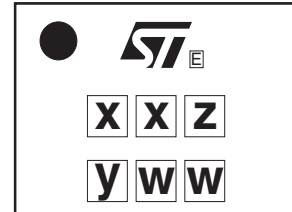
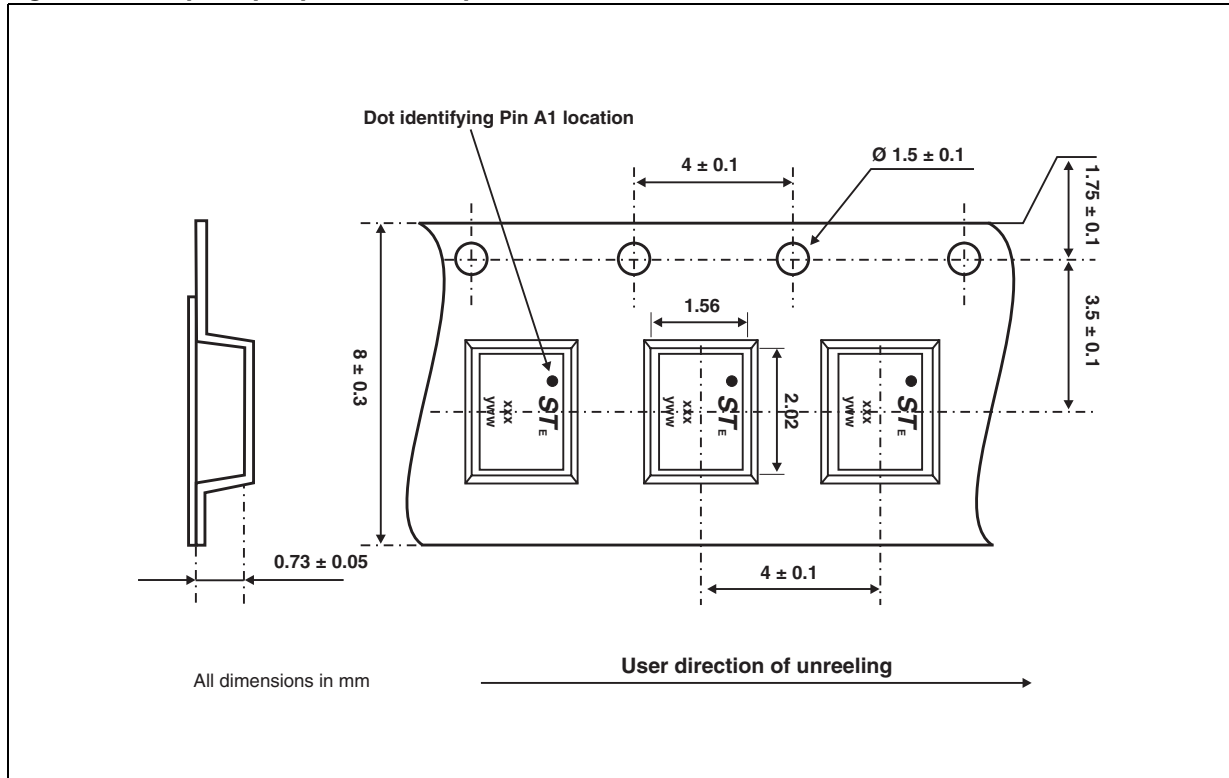

Figure 12. Flip Chip tape and reel specifications



Note: Note: More information is available in the application note:
AN2348: "Flip Chip: Package description and recommendations for use"
AN1751: "EMI filters: Recommendations and measurements"

4 Ordering information

Table 3. Ordering information

Order code	Marking	Package	Weight	Base qty	Delivery mode
EMIF04-EAR01F2	GK	Flip Chip	3.8 mg	5000	Tape and reel 7"

5 Revision history

Table 4. Document revision history

Date	Revision	Changes
06-Oct-2006	1	Initial release.
28-Apr-2008	2	Updated ECOPACK statement. Updated figures Figure 9 , and Figure 12 . Reformatted to current standards.

Please Read Carefully:

Information in this document is provided solely in connection with ST products. STMicroelectronics NV and its subsidiaries ("ST") reserve the right to make changes, corrections, modifications or improvements, to this document, and the products and services described herein at any time, without notice.

All ST products are sold pursuant to ST's terms and conditions of sale.

Purchasers are solely responsible for the choice, selection and use of the ST products and services described herein, and ST assumes no liability whatsoever relating to the choice, selection or use of the ST products and services described herein.

No license, express or implied, by estoppel or otherwise, to any intellectual property rights is granted under this document. If any part of this document refers to any third party products or services it shall not be deemed a license grant by ST for the use of such third party products or services, or any intellectual property contained therein or considered as a warranty covering the use in any manner whatsoever of such third party products or services or any intellectual property contained therein.

UNLESS OTHERWISE SET FORTH IN ST'S TERMS AND CONDITIONS OF SALE ST DISCLAIMS ANY EXPRESS OR IMPLIED WARRANTY WITH RESPECT TO THE USE AND/OR SALE OF ST PRODUCTS INCLUDING WITHOUT LIMITATION IMPLIED WARRANTIES OF MERCHANTABILITY, FITNESS FOR A PARTICULAR PURPOSE (AND THEIR EQUIVALENTS UNDER THE LAWS OF ANY JURISDICTION), OR INFRINGEMENT OF ANY PATENT, COPYRIGHT OR OTHER INTELLECTUAL PROPERTY RIGHT.

UNLESS EXPRESSLY APPROVED IN WRITING BY AN AUTHORIZED ST REPRESENTATIVE, ST PRODUCTS ARE NOT RECOMMENDED, AUTHORIZED OR WARRANTED FOR USE IN MILITARY, AIR CRAFT, SPACE, LIFE SAVING, OR LIFE SUSTAINING APPLICATIONS, NOR IN PRODUCTS OR SYSTEMS WHERE FAILURE OR MALFUNCTION MAY RESULT IN PERSONAL INJURY, DEATH, OR SEVERE PROPERTY OR ENVIRONMENTAL DAMAGE. ST PRODUCTS WHICH ARE NOT SPECIFIED AS "AUTOMOTIVE GRADE" MAY ONLY BE USED IN AUTOMOTIVE APPLICATIONS AT USER'S OWN RISK.

Resale of ST products with provisions different from the statements and/or technical features set forth in this document shall immediately void any warranty granted by ST for the ST product or service described herein and shall not create or extend in any manner whatsoever, any liability of ST.

ST and the ST logo are trademarks or registered trademarks of ST in various countries.

Information in this document supersedes and replaces all information previously supplied.

The ST logo is a registered trademark of STMicroelectronics. All other names are the property of their respective owners.

© 2008 STMicroelectronics - All rights reserved

STMicroelectronics group of companies

Australia - Belgium - Brazil - Canada - China - Czech Republic - Finland - France - Germany - Hong Kong - India - Israel - Italy - Japan - Malaysia - Malta - Morocco - Singapore - Spain - Sweden - Switzerland - United Kingdom - United States of America

www.st.com