

EVEREADY BATTERY CO. 1-800-383-7323 / USA
Internet: www.energizer.com 1-800-383-7323 / CANADA
+ 44 (0) 208 920 2306 / EUROPE

ENERGIZER NO. EN22

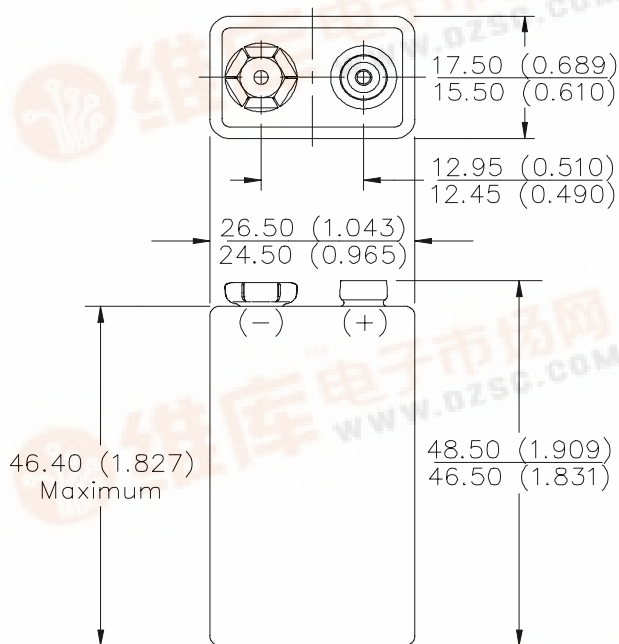

Industry Standard Dimensions in mm (inches)



9V

NOT INTENDED FOR RETAIL TRADE

Chemical System: Alkaline
Zinc-Manganese Dioxide (Zn/MnO₂)
(No Added Mercury or Cadmium)

Designation: ANSI-1604A, IEC-6LR61

Battery Voltage: 9.0 Volts

Operating Temp: -18°C to 55°C (0°F to 130°F)

Average Capacity: 625 mAh (to 0.8 volts/cell)
(Rated capacity at 25 mA continuous drain)

Average Weight: 45.6 grams (1.6 oz.)

Volume: 21.1 cubic centimeters (1.3 cubic inch)

Cell: Six No. 3-0316 in series

Jacket: Metal

Shelf Life: 5 years (80% of rated capacity)

TEMPERATURE EFFECTS Typical Service to 4.8 Volts

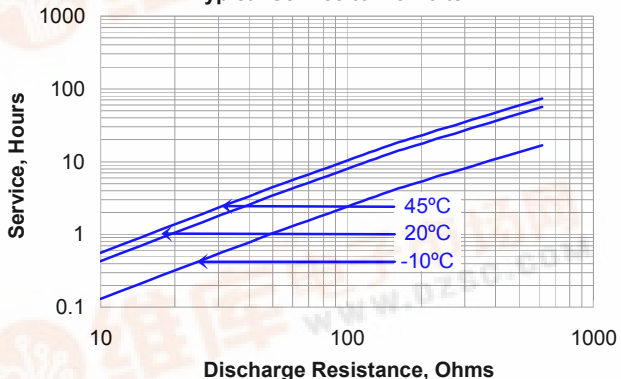

CONSTANT RESISTANCE PERFORMANCE Typical Service

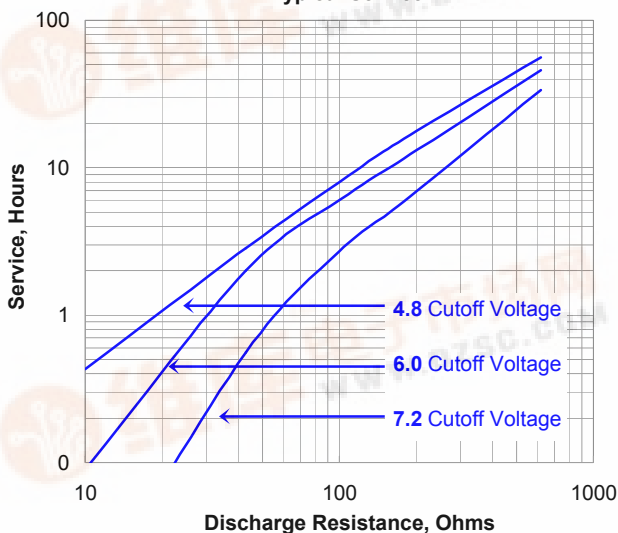

CONSTANT CURRENT DISCHARGE Typical Service

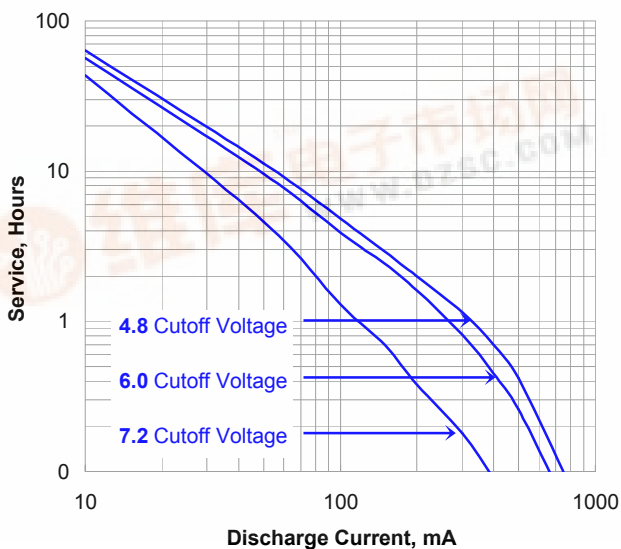

Important Notice

This data sheet contains information specific to batteries manufactured at the time of its publication.

Contents herein do not constitute a warranty.

Copyright © Eveready Battery Co. - All rights reserved



ENERGIZER NO. EN22

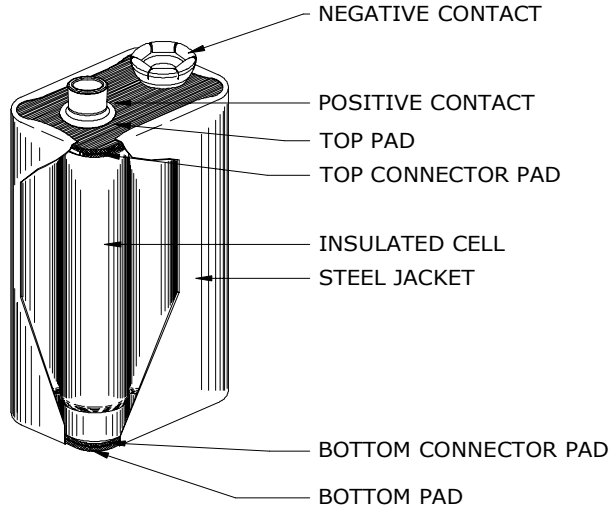

Industry Standard Tests @ 20° C

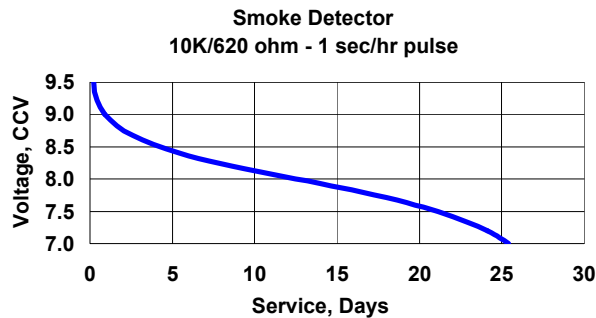
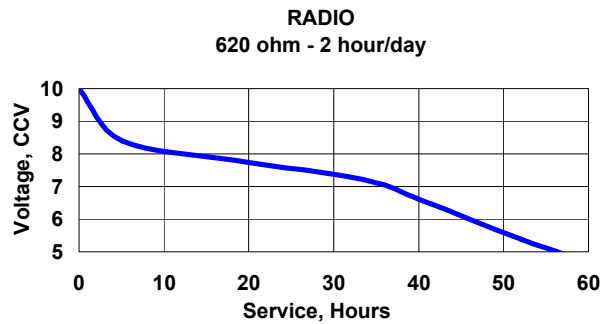
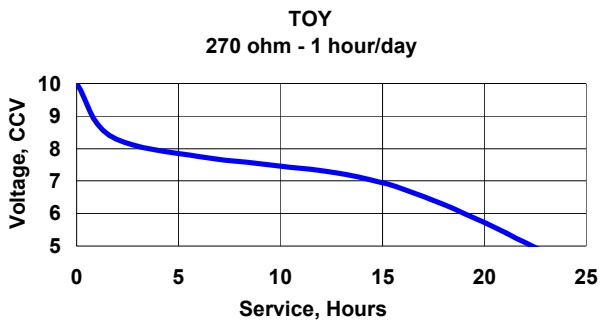

Important Notice

This data sheet contains information specific to batteries manufactured at the time of its publication.

Contents herein do not constitute a warranty.

Copyright © Eveready Battery Co. - All rights reserved