

EVEREADY BATTERY CO. 1-800-383-7323 / USA
Internet: www.energizer.com 1-800-383-7323 / CANADA
+ 44 (0) 208 920 2306 / EUROPE

ENERGIZER NO. EN93

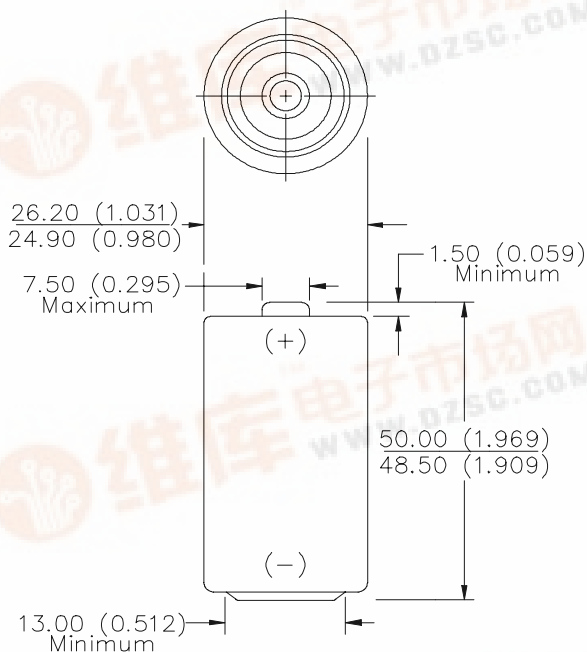

Industry Standard Dimensions in mm (inches)



Negative cover detail referenced on page 2

C

NOT INTENDED FOR RETAIL TRADE

- Chemical System:** Alkaline
Zinc-Manganese Dioxide (Zn/MnO₂)
(No Added Mercury or Cadmium)
- Designation:** ANSI-14A, IEC-LR14
- Battery Voltage:** 1.5 Volts
- Internal Resistance:** 324 Milliohms (Fresh)
- Operating Temp:** -18°C to 55°C (0°F to 130°F)
- Average Capacity:** 8,350 mAh (to 0.8 volts)
(Rated capacity at 25 mA continuous drain)
- Average Weight:** 66.2 grams (2.3 oz.)
- Volume:** 26.9 cubic centimeters (1.6 cubic inch)
- Cell:** One No. 3-335 (size 'C')
- Jacket:** Plastic Label
- Shelf Life:** 7 years (80% of rated capacity)

TEMPERATURE EFFECTS Typical Service to 0.8 Volts

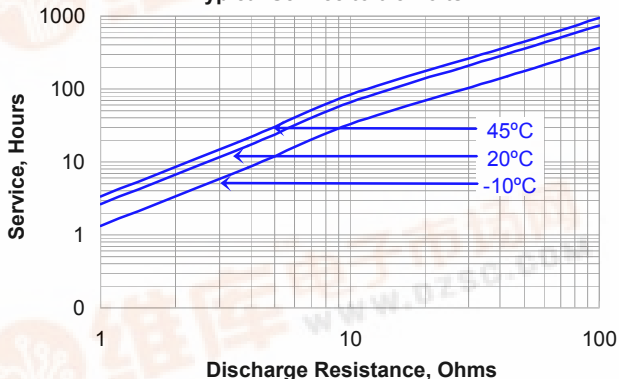

CONSTANT RESISTANCE PERFORMANCE Typical Service

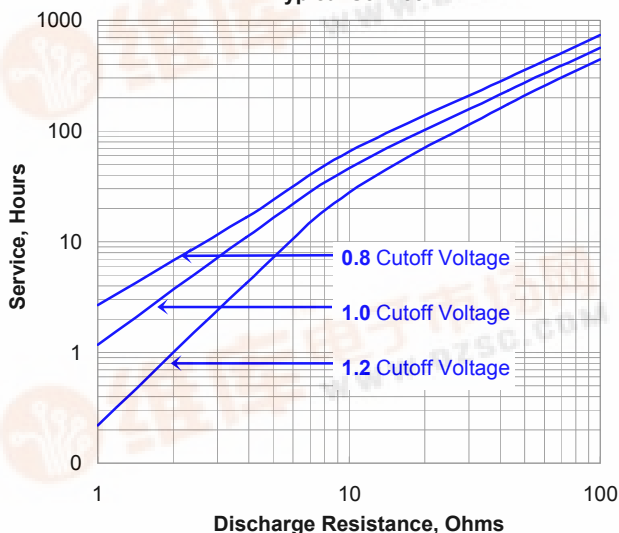

CONSTANT CURRENT DISCHARGE Typical Service

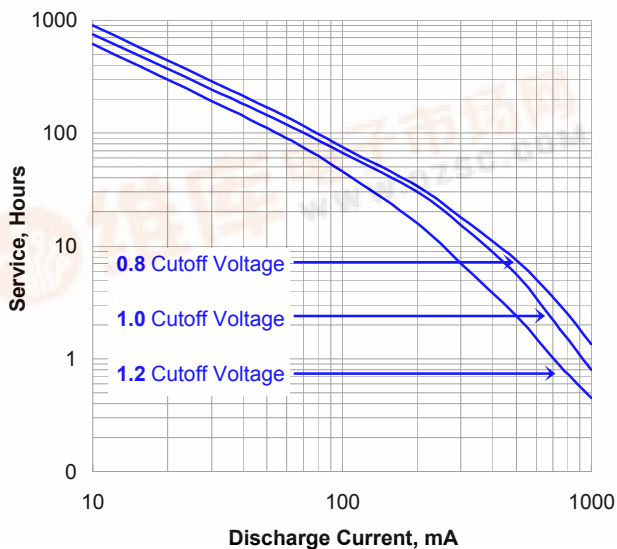

Important Notice

This data sheet contains information specific to batteries manufactured at the time of its publication.

Contents herein do not constitute a warranty.

Copyright © Eveready Battery Co. - All rights reserved



ENERGIZER NO. EN93

NEGATIVE COVER VIEW

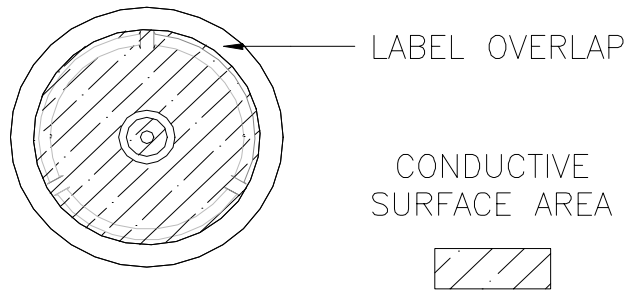

Industry Standard Tests @ 20° C

TOY
3.9 ohm - 1 hr/day



PORTABLE LIGHTING
3.9 ohm - LIF

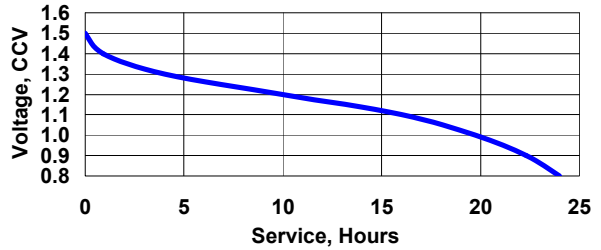

PORTABLE STEREO
400 mA - 2 hr/day

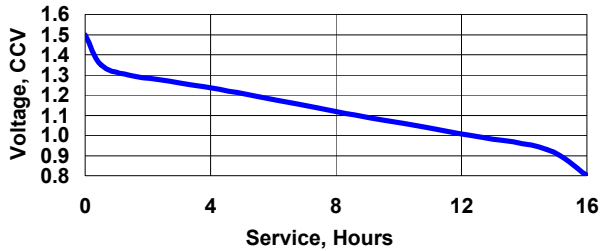

RADIO
20 ohm - 4 hr/day

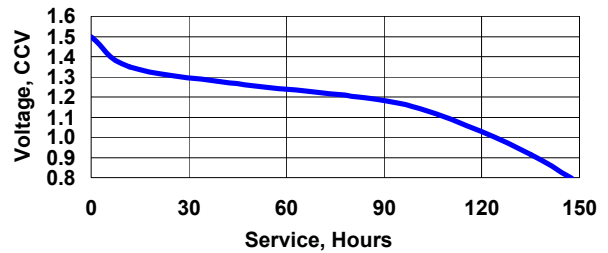

Important Notice

This data sheet contains information specific to batteries manufactured at the time of its publication.

Contents herein do not constitute a warranty.

Copyright © Eveready Battery Co. - All rights reserved