

B GALAXY ELECTRICAL

ERC38-04 --- ERC38-06

HIGH EFFICIENCY RECTIFIER

VOLTAGE RANGE: 400 --- 600 V
CURRENT: 1.0 A

FEATURES

- ◇ Low cost
- ◇ Diffused junction
- ◇ Low leakage
- ◇ Low forward voltage drop
- ◇ High current capability
- ◇ Easily cleaned with alcohol, Isopropanol and similar solvents
- ◇ The plastic material carries U/L recognition 94V-0

MECHANICAL DATA

- ◇ Case: JEDEC DO--41, molded plastic
- ◇ Terminals: Axial lead, solderable per MIL- STD-202, Method 208
- ◇ Polarity: Color band denotes cathode
- ◇ Weight: 0.012 ounces, 0.34 grams
- ◇ Mounting position: Any

DO - 41

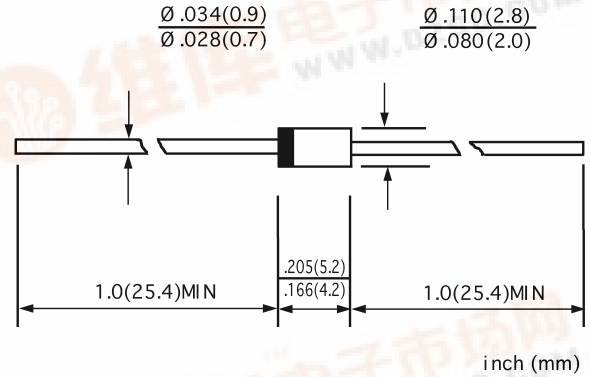

MAXIMUM RATINGS AND ELECTRICAL CHARACTERISTICS

Ratings at 25°C ambient temperature unless otherwise specified.

Single phase, half wave, 60 Hz, resistive or inductive load. For capacitive load, derate by 20%.

		ERC38 - 04	ERC38 - 05	ERC38 - 06	UNITS
Maximum recurrent peak reverse voltage	V_{RRM}	400	500	600	V
Maximum RMS voltage	V_{RMS}	280	350	420	V
Maximum DC blocking voltage	V_{DC}	400	500	600	V
Maximum average forward rectified current 9.5mm lead length, @ $T_A=75^\circ C$	$I_{F(AV)}$	1.0			A
Peak forward surge current 8.3ms single half-sine-wave superimposed on rated load @ $T_J=125^\circ C$	I_{FSM}	40.0			A
Maximum instantaneous forward voltage @ 1.0A	V_F	2.5			V
Maximum reverse current @ $T_A=25^\circ C$ at rated DC blocking voltage @ $T_A=100^\circ C$	I_R	5.0 50.0			μA
Maximum reverse recovery time (Note1)	t_{rr}	50			ns
Typical junction capacitance (Note2)	C_J	20	15		pF
Typical thermal resistance (Note3)	$R_{\theta JA}$	60			$^\circ C/W$
Operating junction temperature range	T_J	- 55 ----- + 150			$^\circ C$
Storage temperature range	T_{STG}	- 55 ----- + 150			$^\circ C$

NOTE: 1. Measured with $I_F=0.5A$, $I_R=1A$, $I_{rr}=0.25A$.

2. Measured at 1.0MHz and applied reverse voltage of 4.0V DC.

3. Thermal resistance from junction to ambient.

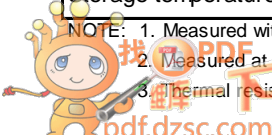
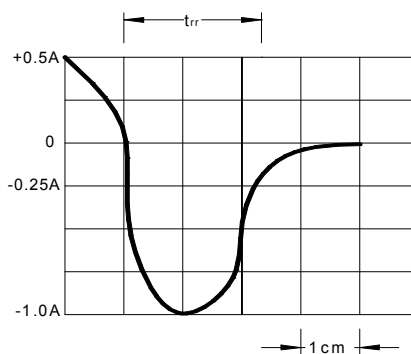
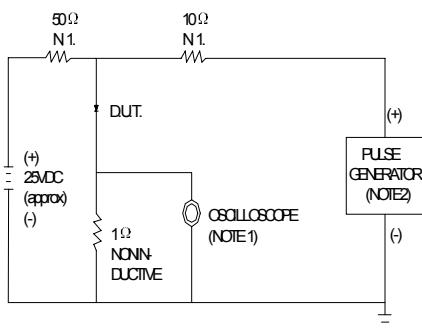

FIG.1-TEST CIRCUIT DIAGRAM AND REVERSE RECOVERY TIME CHARACTERISTIC



NOTES: 1. RISE TIME=7ns MAX. INPUT IMPEDANCE=1MΩ. 22pF
2. RISE TIME=10ns MAX. SOURCE IMPEDANCE=50Ω.

SET TIME BASE FOR 20/30 ns/cm

FIG.2 -FORWARD DERATING CURVE

AVERAGE FORWARD RECTIFIED CURRENT.
AMPERES

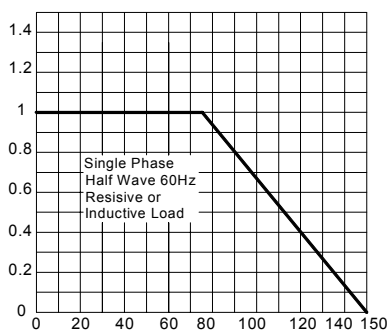

AMBIENT TEMPERATURE. °C

FIG.3-TYPICAL JUNCTION CAPACITANCE

JUNCTION CAPACITANCE, pF

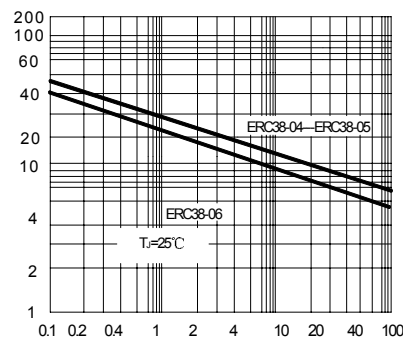

REVERSE VOLTAGE, VOLTS

FIG.4-PEAK FORWARD SURGE CURRENT

PEAK FORWARD SURGE CURRENT.
AMPERES

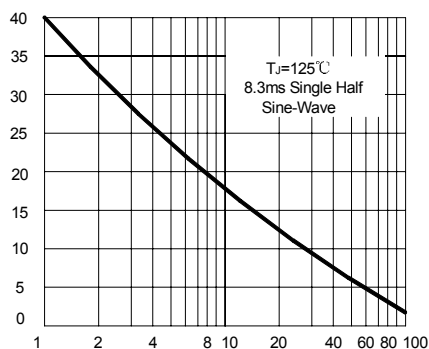

NUMBER OF CYCLES AT 60 Hz

FIG.5 - TYPICAL FORWARD CHARACTERISTIC

INSTANTANEOUS FORWARD CURRENT
AMPERES

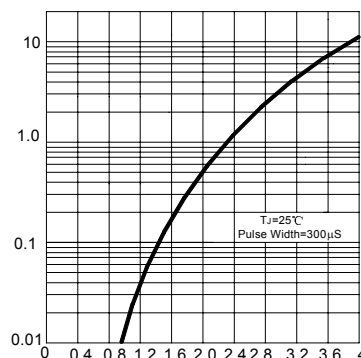

INSTANTANEOUS FORWARD VOLTAGE, VOLTS