

[查询ESLT-S245E供应商](#)

[捷多邦, 专业PCB打样工厂, 24小时加急出货](#)

2012 Size

2.4/2.5GHz Band  
Chip Multilayer RF Transformer

Impedance Ratio 50:50

ESLT-S245E



All the technical data and information contained herein are subject to change without notice.



LT-ESLT-S245E-0410A

# Shape & Size

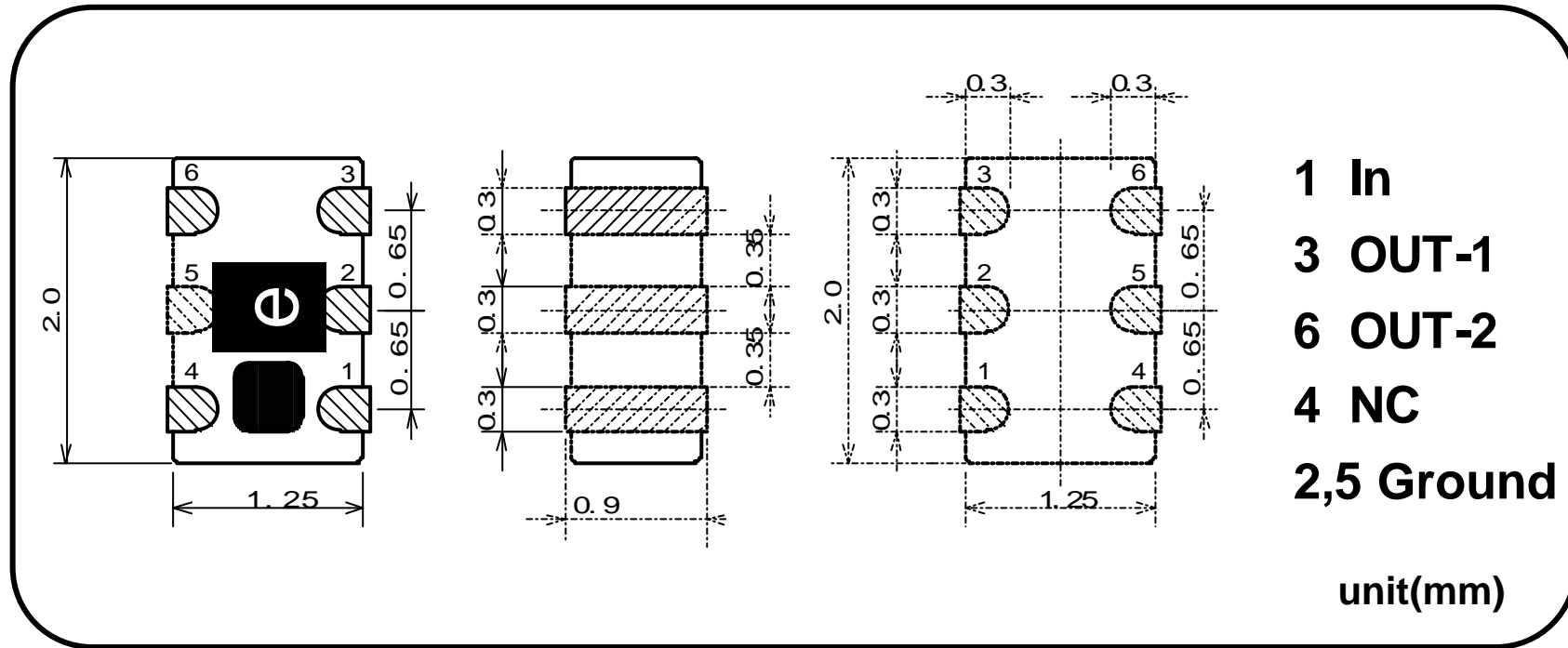

## Specifications

P/N	Frequency Range(GHz)	Impedance ratio	Insertion Loss*1	Return Loss (Unbalanced)	Phase Balance	Handling Power	Temperature Range
ESLT-S245E	2.4-2.5	50:50	1.2dB Max.	10dB Min.	180 +/-10deg.	0.5W Max.	-40 to +85 deg.C

\*1:Back to Back(/piece)

# ESLT-S245E Sample Data

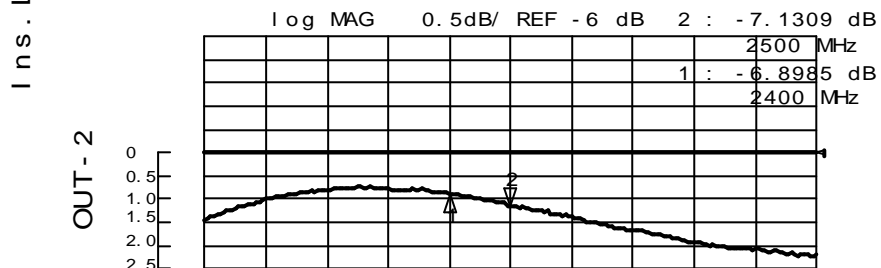
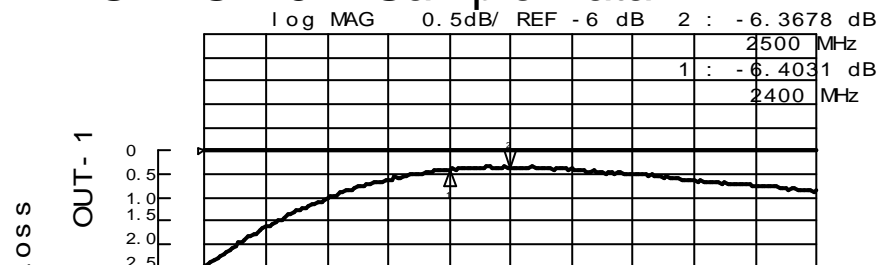

Insertion Loss(Out 1, Out 2):  
measurement-splitting loss-resistor loss

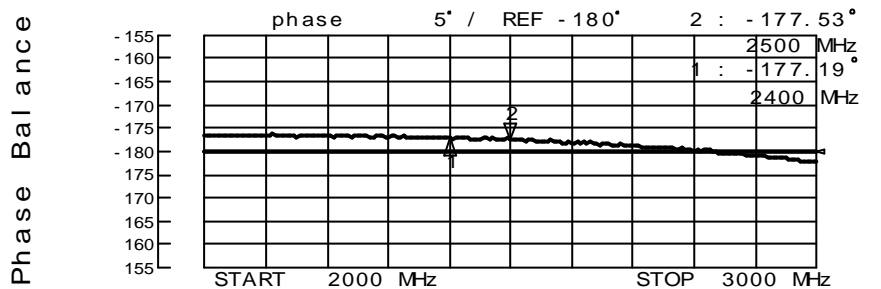
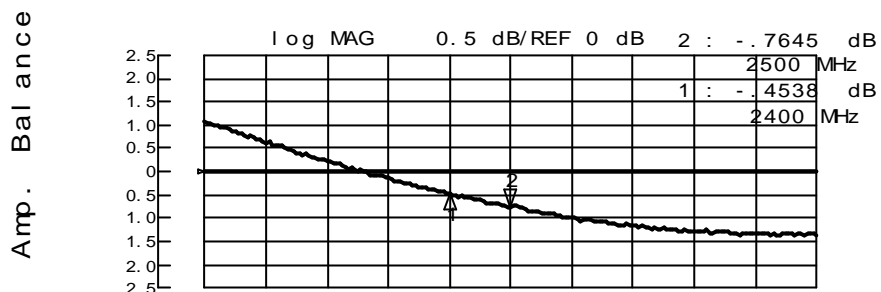

1 U FS 2 : 40.074ohm - 11.756ohm 5.448 pF  
2500 MHz

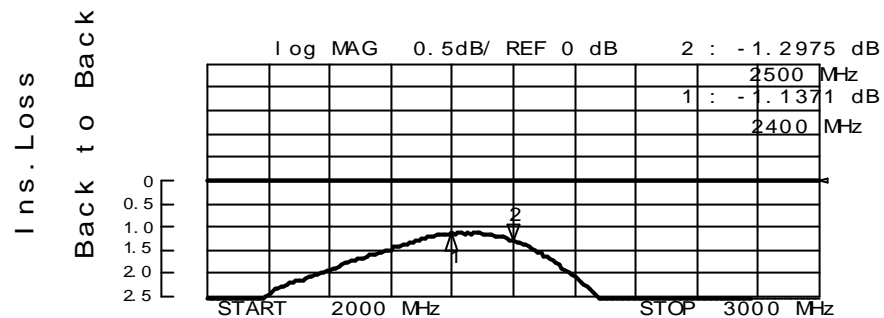
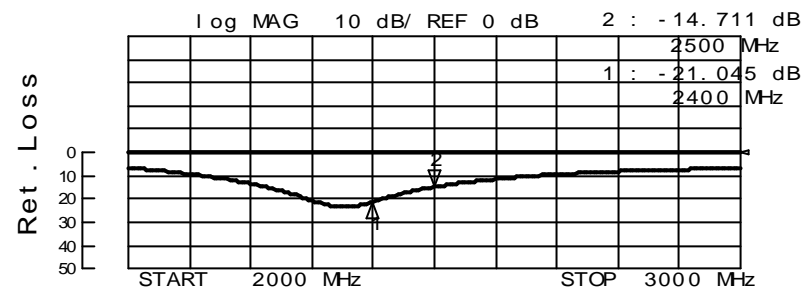
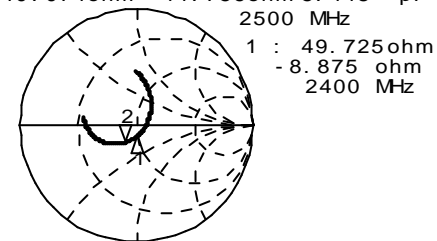

All the technical data and information contained herein are subject to change without notice.

# FOOT PATTERN

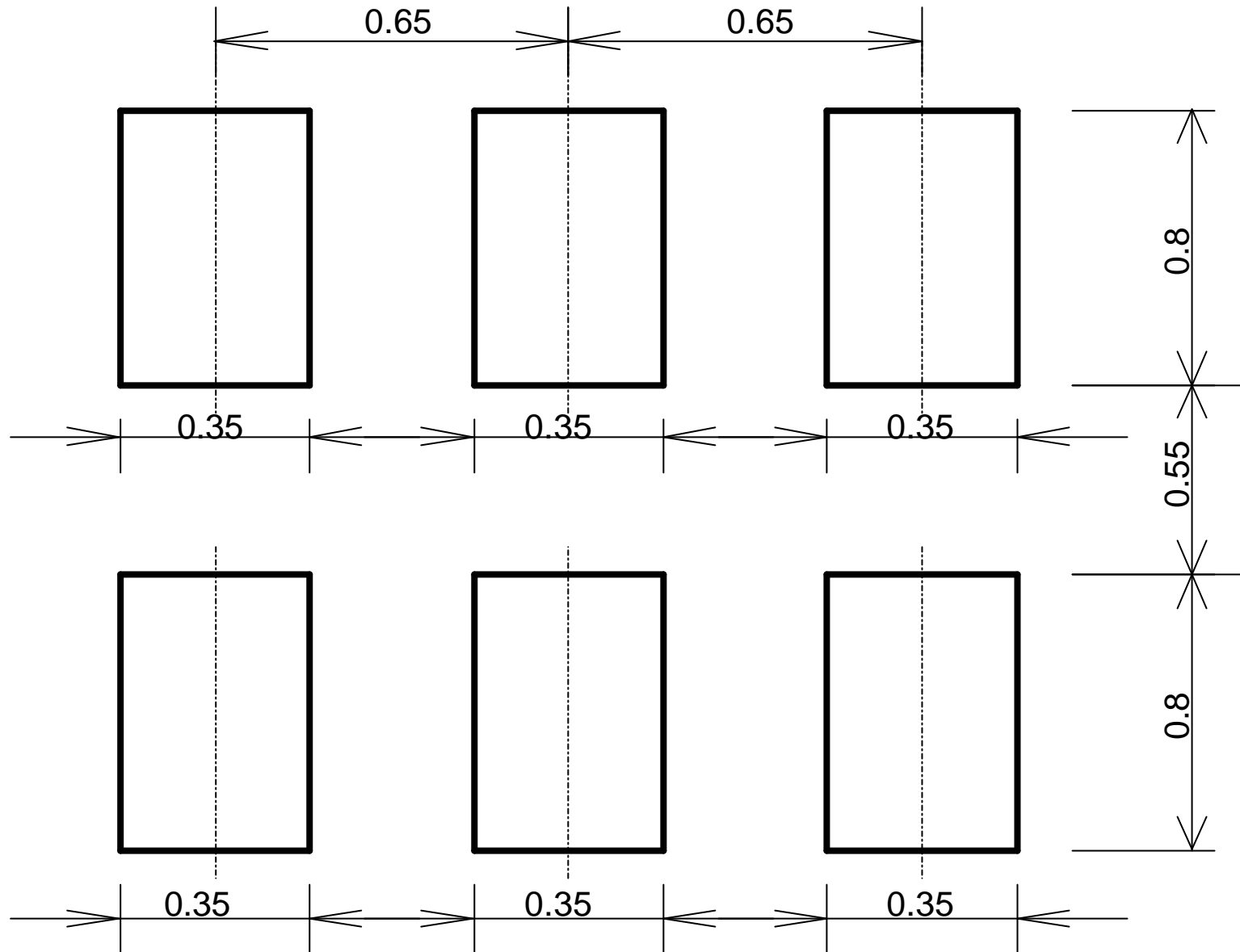

All the technical data and information contained herein are subject to change without notice.

**LT-ESLT-S245E-0410A**