

Oil-resistive, long-distance photoelectric sensor (metal case)

E3S-C

Achieves excellent water/oil-resistance and long-distance detection.



Features

Meets IP67 tough standard water/oil resistance

E3S-C meets the IP67 requirements of the IEC standards and 6P of the NEMA standards. E3S-C can be used worry-free in automotive assembly lines and other production lines where oil vapor exists. It can also be applied to food processing lines because it resists hydrogen peroxide, detergent and potassium hydroxide.

Sensing distance is six times longer than that of conventional OMRON photoelectric sensor

The sensing distance of the E3S-C is six times longer than that of the conventional, metal case type OMRON photoelectric sensor. The through-beam, retroreflective (with M.S.R. function) and diffuse reflective models have sensing distances of 30, 3 and 2 meters, respectively.

Through-beam Model	5m E3S-5E4	30m
Retroreflective Model	2 m (non-polarized) E3S-R2E4	3 m (polarized)
Diffuse Reflective Model	300mm E3S-DS30E4	2m

Excellent shock resistance of 1,000 m/s²

The industry's top-class photoelectric sensor features shock resistance of 1,000 m/s², which is as high as that of a proximity sensor at rated values, and vibration resistance of as high as 10 to 2,000 Hz. The E3S-C can be used worry-free in metal processing, conveyor and other lines.

Lineup of M12 metal connector joint type models

Lineup of water/oil/shock-resistant M12 metal connector joint type models are available. This series ensures ease of sensor replacement during maintenance.

NPN/PNP output selector

The operation panel has the NPN/PNP output selector. You need not prepare two NPN and PNP models for export. You need not worry about malfunctions due to noise, either.



Mutual interference prevention enhanced

(Retroreflective, diffuse reflective models)

Fuzzy inference is introduced into the mutual interference prevention for the first time in the industry. This prevents a malfunction due to mutual interference, enabling two sensors to be mounted closely side by side.

Easy optical axis alignment

OMRON's original "automatic position compensation system" minimizes misalignment of mechanical and optical axes to merely ±2°. The optical axis is aligned perfectly by only installing the sensor.

PAT Pending

First in the Industry

Application

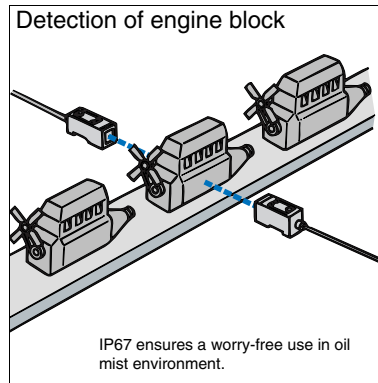
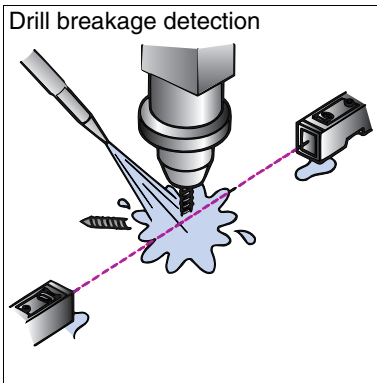

Ordering Information

Sensors

Red light Infrared light

Sensor type	Shape	Connection method	Sensing distance	Model
Through-beam	Horizontal Model 	Pre-wired	30m	E3S-CT11
		Junction connector		E3S-CT11-M1J
	Vertical Model 	Pre-wired		E3S-CT61
		Junction connector		E3S-CT61-M1J
Retroreflective Models	Horizontal Model 	Pre-wired	3m	E3S-CR11
		Junction connector		E3S-CR11-M1J
	Vertical Model 	Pre-wired		E3S-CR61
		Junction connector		E3S-CR61-M1J
Diffuse-reflective	Horizontal Model 	Pre-wired	700mm	E3S-CD11
			2m	E3S-CD12
		Junction connector	700mm	E3S-CD11-M1J
			2m	E3S-CD12-M1J
	Vertical Model 	Pre-wired	700mm	E3S-CD61
			2m	E3S-CD62
		Junction connector	700mm	E3S-CD61-M1J
			2m	E3S-CD62-M1J

Accessories (Order Separately)

Slits

Slit width	Sensing distance	Minimum sensing object (typical)	Model	Quantity	Remarks
Width 0.5 mmx11 mm	1.8 m	0.5 mm dia.	E39-S61	1 each for emitter and receiver (total of 8 pcs.)	(Plug-in type long slit) Can be used with through-beam E3S-CT□1 (-M1J).
Width 1 mmx11 mm	3.5 m	1 mm dia.			
Width 2 mmx11 mm	7 m	2 mm dia.			
Width 4 mmx11 mm	15 m	2.6 mm dia.			

Reflectors

Name	Sensing distance (typical)	Model	Quantity	Remarks
Reflectors	3 m (rated value)	E39-R1	1	Attached to the Retroreflective E3S-CR□1 (-M1J).
	4 m	E39-R2	1	---
Small reflector	1.5 m	E39-R3	1	---
	750 mm	E39-R4	1	---
Tape Reflector	700 mm (50 mm) *	E39-RS1	1 pc.	The M.S.R. function is available.
	1,100 mm (100 mm) *	E39-RS2	1 pc.	
	1,400 mm (100 mm) *	E39-RS3	1 pc.	

* Values in parentheses indicate the minimum required distance between the sensor and reflector.

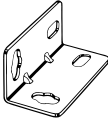
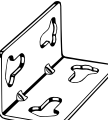
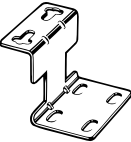
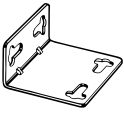
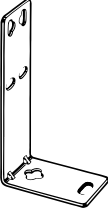

Note: 1. When the reflector used is other than the supplied one, set the sensing distance to about 0.7 times of the typical example as a guideline.

Mounting Brackets

Shape	Model	Quantity	Remarks
	E39-L102	1	Attached to the horizontal model.
	E39-L103	1	Attached to the vertical model.
	E39-L85	1	Mounting bracket designed to switch from E3S-□□□□42, 44 to the vertical model of E3S-C.
	E39-L86	1	Mounting bracket designed to switch from E3S-□□□□43 to the vertical model of E3S-C.
	E39-L87	1	---

Note: If a through-beam model is used, order two Mounting Brackets for the emitter and receiver respectively.

Sensor I/O Connectors

Cable	Shape	Cable length		Model
Standard cable	Straight 	2 m	3-wire type	XS2F-D421-DC0-A
		5 m		XS2F-D421-GC0-A
	L-shaped 	2 m		XS2F-D422-DC0-A
		5 m		XS2F-D422-GC0-A

Rating/performance

Sensor type		Through-beam	Retroreflective model (with M.S.R. function)	Diffuse-reflective	
Item	Model	Horizontal E3S-CT11 (-M1J)	Horizontal E3S-CR11 (-M1J)	Horizontal E3S-CD11 (-M1J)	Horizontal E3S-CD12 (-M1J)
		Vertical E3S-CT61 (-M1J)	Vertical E3S-CR61 (-M1J)	Vertical E3S-CD61 (-M1J)	Vertical E3S-CD62 (-M1J)
Sensing distance	30 m		3 m (When using the E39-R1)	700 mm (White paper 300 x 300 mm)	2 m (White paper 300 x 300 mm)
Standard sensing object	Opaque, 15dia. min.		Opaque: 75 mm dia. min.	---	
Differential distance	---			20% max. of sensing distance	
Directional angle	Both emitter and receiver: 3° to 15°		3° to 10°	---	
Light source (wave length)	Infrared LED (880 nm)		Red LED (700 nm)	Infrared LED (880 nm)	
Supply voltage	10 to 30 VDC [ripple (p-p) 10% included]				
Current consumption	Both emitter and receiver: 25 mA max.		40 mA max.		
Control output	Load supply voltage 30 VDC max., load current 100 mA max. (residual voltage NPN output: 1.2 V max., PNP output: 2.0 V max.) Open collector output type (NPN/PNP switch selectable) Light-ON/Dark-ON switch selectable				
Protective circuits	Reverse polarity protection, output short-circuit protection		Reverse polarity protection, output short-circuit protection, mutual interference prevention		
Response time	Operation or reset: 1 ms max.				Operation/reset: 2 ms max. each
Sensitivity adjustment	Single-turn adjustment			2-turn endless adjuster (with indicator)	
Ambient illuminance	(on Receiver lens) Incandescent lamp: 5,000 lux max. Sunlight: 10,000 lux max.				
Ambient temperature	Operating: -25°C to 55°C, Storage: -40°C to 70°C (with no icing or condensation)				
Ambient humidity	Operating: 35% to 85%RH, Storage: 35% to 95%RH (with no condensation)				
Insulation resistance	20 M Ω min. at 500 VDC				
Dielectric strength	1,000 VAC at 50/60 Hz 1 minute				
Vibration resistance	10 to 2,000 Hz double amplitude 1.5 mm or 300 m/s ² for 0.5 h in each of X, Y, Z directions				
Shock resistance	1000 m/s ² (approx. - 100G) 3 times each in X, Y, and Z directions				
Protective structure	IEC Standard IP67, NEMA 6P (limited to indoors use) *				
Connection method	Pre-wired (standard length: 2 m), Junction connector (standard length: 300 mm)				
Weight (Packed state)	About 270 g (pre-wired type) About 230 g (M12 connector joint type)		About 160 g (pre-wired type) About 130 g (M12 connector joint type)	About 150 g (pre-wired type) About 110 g (M12 connector joint type)	
Material	Case	Zinc diecast			
	Operation panel cover	Polyethyl sulfon			
	Lens	Acrylics			
	Mounting Brackets	Stainless steel (SUS304)			
Accessories	Mounting bracket (with screws), adjusting screwdriver, instruction manual, reflector (Retroreflective model only)				

* NEMA (National Electrical Manufacturers Association) Standards

Output Circuit Diagram

NPN output

Model	Operating status of output transistor	Timing chart	Mode selection switch	Output circuit
E3S-CT11(-M1J) E3S-CT61(-M1J) E3S-CR11(-M1J) E3S-CR61(-M1J) E3S-CD11(-M1J) E3S-CD12(-M1J) E3S-CD61(-M1J) E3S-CD62(-M1J)	Light ON		L•ON (LIGHT ON)	<p>Receiver (Through-beam Models) Retroreflective, Diffuse Reflective, and Limited Reflective Models</p> <p>* Note: Set the NPN and PNP output selector to NPN.</p> <p>Connector Pin Arrangement</p> <p>Note: Terminal 2 is not used.</p>
	Dark ON		D•ON (DARK ON)	<p>Emitter (Through-beam Models)</p> <p>Connector Pin Arrangement</p> <p>Note: Terminal 2 and 4 are not used.</p>

PNP output

Model	Operating status of output transistor	Timing chart	Mode selection switch	Output circuit
E3S-CT11(-M1J) E3S-CT61(-M1J) E3S-CR11(-M1J) E3S-CR61(-M1J) E3S-CD11(-M1J) E3S-CD12(-M1J) E3S-CD61(-M1J) E3S-CD62(-M1J)	Light ON		L•ON (LIGHT ON)	<p>Receiver (Through-beam Models) Retroreflective, Diffuse Reflective, and Limited Reflective Models</p> <p>* Note: Set the NPN and PNP output selector to PNP.</p> <p>Connector Pin Arrangement</p> <p>Note: Terminal 2 is not used.</p>
	Dark ON		D•ON (DARK ON)	<p>Emitter (Through-beam Models)</p> <p>Connector Pin Arrangement</p> <p>Note: Terminal 2 and 4 are not used.</p>

Connectors (Sensor I/O connectors)

Class	Wire, outer jacket color	Connector pin No.	Application
For DC	Brown	①	+V
	---	②	---
	Blue	③	0V
	Black	④	Output

Note: Pin 2 is open.

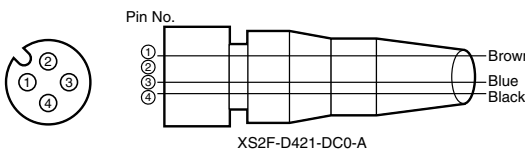

Characteristic data (typical)

Operating Range

Through-beam
E3S-CT□1(-M1J)

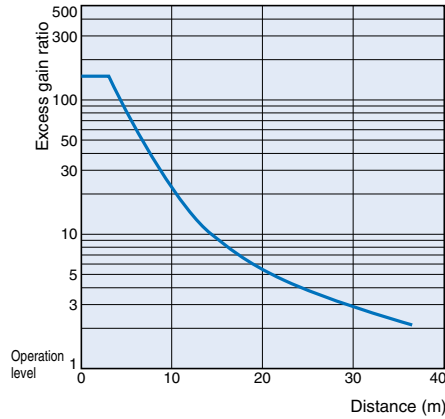

Retroreflective Models
E3S-CR□1 (-M1J) + E39-R1 (supplied reflector)

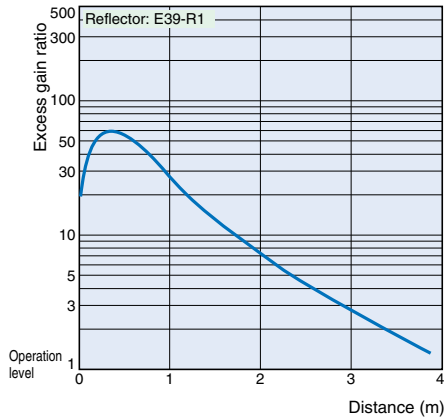

Diffuse-reflective
E3S-CD□□(-M1J)

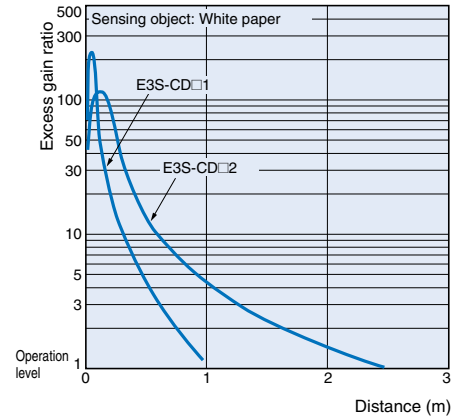

Nomenclature:

(Horizontal type)

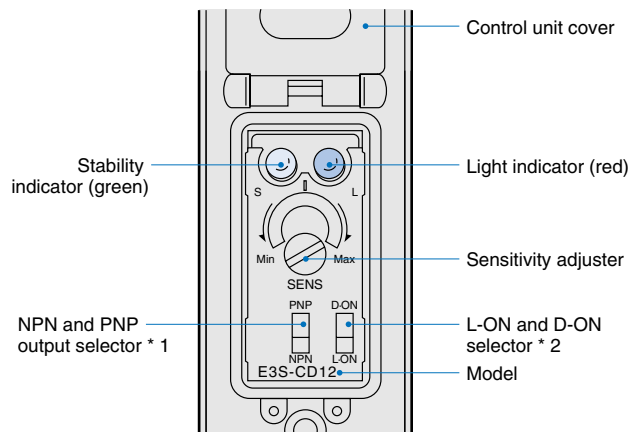

(Vertical type)

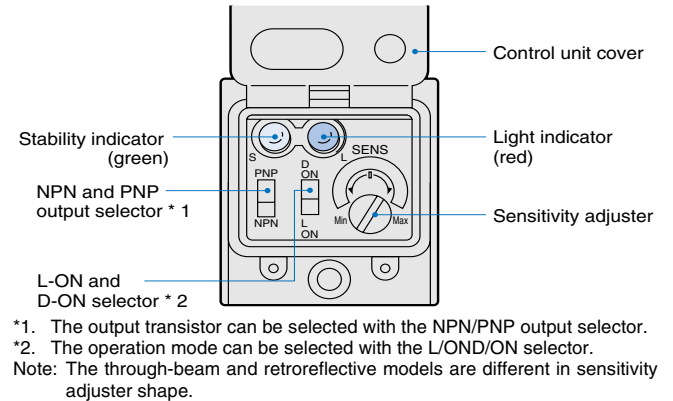

Operation

Sensitivity adjustment (diffuse reflective model, light-ON)

Sequence	Detection state	Sensitivity adjuster	Indicator state	Adjustment procedure
① Point A			ON→OFF OFF→ON Stability indicator (green) Light indicator (red)	Place a sensing object in the predetermined position, turn the sensitivity adjuster clockwise (increase sensitivity) until the incident indicator (red) is turned ON, and define this position as (A).
② Point B			ON→OFF ON→OFF Stability indicator (green) Light indicator (red)	Remove the sensing object, turn the sensitivity adjuster further clockwise until the incident indicator (red) is turned ON by a background object, and define this position as (B). Turn the sensitivity adjuster counterclockwise (decrease sensitivity) from (B) until the incident indicator (red) is turned OFF, and define this position as (C). When there is no background object, define the maximum adjuster position (Max) as (C).
③ Setting	---		ON ON↔OFF Stability indicator (green) Light indicator (red)	Set the adjuster in the middle of positions (A) and (C) (optimum sensitivity setting). Also make sure that the stability indicator (green) is turned ON when there is an object and when there is no object. When the indicator is not turned ON, recheck the detection method since there is a little allowance.

Unlike the conventional models, the E3S-C scarcely has sensitivity variations between products. Therefore, you need to make the above adjustment on only one diffuse reflective model of E3S-CD that will be used for detection under the same conditions, and match the indicator points of the other diffuse reflective models of E3S-CD with the above adjusted one. (You need not match the sensitivity of each sensor.)

Precautions

Correct Use

Design

Fuzzy mutual interference prevention

When reflective photoelectric sensors are installed side by side, one sensor may receive the light from the other sensor, which may disturb the incident signal, causing a malfunction. The fuzzy mutual interference prevention monitors interfering light for a predetermined period of time before light is emitted, and imports the interfering light level and incident frequencies as data. Using these values, fuzzy inference is made to find the risk of malfunction to control the light emitting timing, reducing the risk.

(When risk is low)

Light is emitted after interfering light is gone.

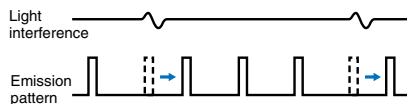

(When risk is high)

Light is emitted after shifting to a gap of interfering light.

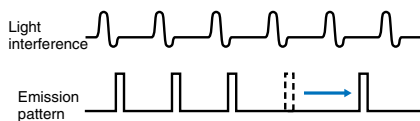

Wiring Considerations

Cable

- An oil-resistance cable is used to ensure oil resistance.
- The bending radius should be 25 mm or more.

Installation

Sensor installation

- Note that during the E35-C installation, hammering it will damage the water resistance function.
- Use an M4 screw, tightened to a torque of no more than 1.18 Nm.

(When using the mounting bracket)

- To set the sensor on the mechanical axis, use the optical axis locking holes.
- When the sensor cannot be set on the mechanical axis, move the E3S-C vertically and/or horizontally and set it in the center of the area where the incident indicator is turned ON. Make sure that the stability indicator is ON.

(Direct installation)

Install the E3S-C as shown below.

[M4 screwing]

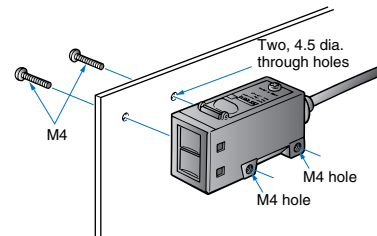

[M3 screwing]

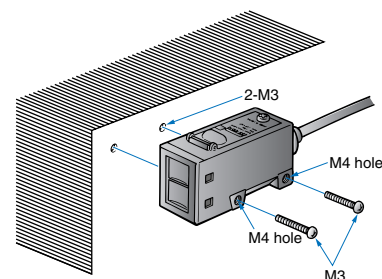

Optical axis adjustment

(Optical axis locking holes)

By fitting screws into the optical axis locking holes, the mounting bracket is set onto the mounting shaft of the mounting bracket.

For adjustment

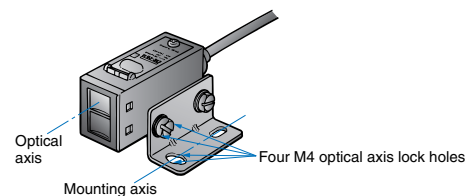

Optical axis position of through-beam model

Unlike the conventional product, the through-beam model has two lenses, but the one actually used is as shown below. When fitting the slit, use it after matching the slit hole with the used lens.

(Horizontal model) (Vertical model)

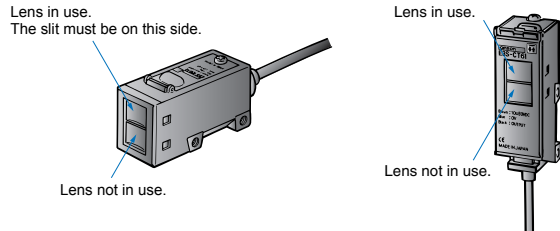

Water Resistance

To ensure water resistance, tighten the operation panel cover screws to 0.34 Nm to 0.54 Nm torque.

Miscellaneous

Oil resistance/chemical resistance

- Though E3S-C has a high oil resistance, it may not be able to exhibit its performance depending on the oil type. Use oil in compliance with the following table.
- Regarding the oil resistance of E3S-C, it has passed tests on the oils given in the following table. Refer to the table for examining the oil to be used.

Testing oil classification	JIS classification	Product name	Dynamic viscosity (mm ² /s) at 40°C	PH
Lubricant	---	Velocity No. 3	2.02	---
Water-insoluble coolant	Class 2 No. 5	Daphne Cut	Not less than 10 to less than 50	
	Class 2 No. 11	Yushiron Oil No. 2ac	Less than 10	
Water-soluble coolant	Class W1 No. 1	Yushiroken EC50T-3	---	7 to 9.5
		Yushiron Lubic HWC68		7 to 9.9
	Class W1 No. 2	Gryton 1700D		7 to 9.2
	Class W2 No. 1	Yushiroken S50N		7 to 9.8

Note: 1. The E3S-C was immersed in the oils in the above table at 50°C for 240 hours, and passed the test of 100-MΩ or more insulation resistance.
 2. For use in the environment where the E3S-C is exposed to the oil other than those in the above table, use the dynamic viscosity and PH in the above table. Pre-examine the oils since the sensor may be affected by additives and like in the oils.

Dimensions (Unit: mm)

Sensors

Through-beam model (horizontal model)

E3S-CT11(-M1J)

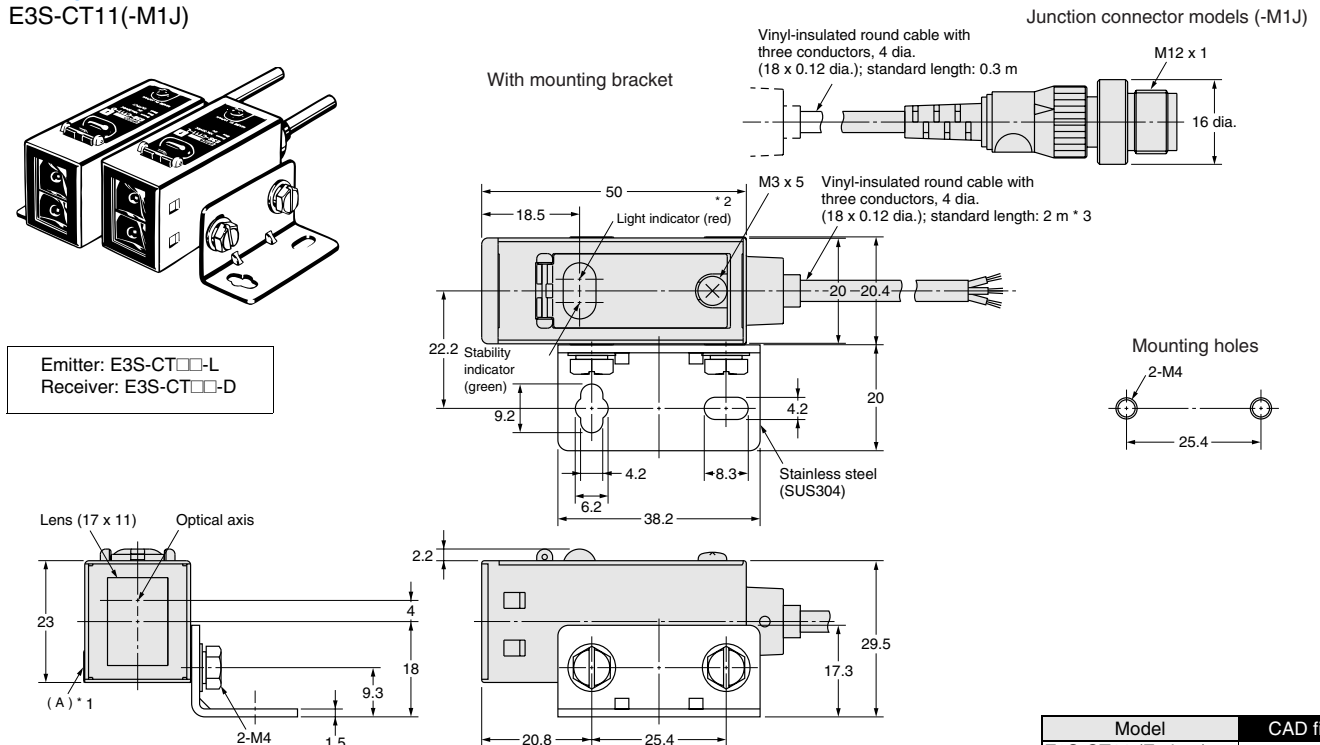

Model	CAD file
E3S-CT11 (Emitter)	E3S_08
E3S-CT11 (Receiver)	E3S_05
E3S-CT11-M1J	E3S_10

* Note: 1. Mounting bracket can be attached to side A.
 2. The emitter for through-beam sensors have only the power supply indicator.
 3. The cable for emitters for through-beam sensors is two-conductor, 4 dia. (27 x 12 dia.).

Through-beam model (vertical model)

E3S-CT61(-M1J)

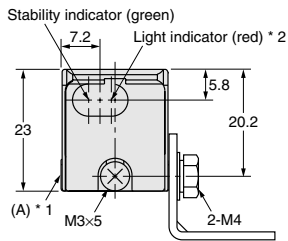
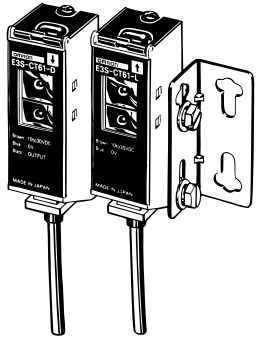

- * 1. Mounting bracket can be attached to side A.
- * 2. The emitter for through-beam sensors have only the power supply indicator.
- * 3. The cable for emitters for through-beam sensors is two-conductor, 4 dia. (27x12 dia.).

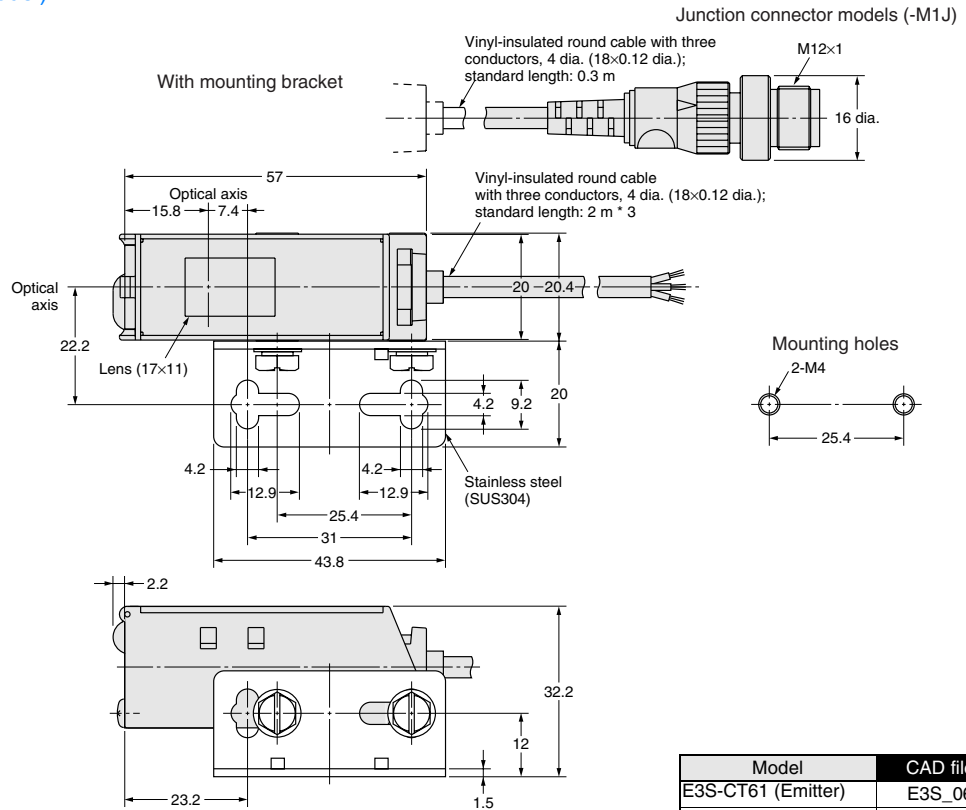

Model	CAD file
E3S-CT61 (Emitter)	E3S_06
E3S-CT61 (Receiver)	E3S_07
E3S-CT61-M1J	E3S_09

Retro/diffuse reflective model (horizontal model)

E3S-CR11(-M1J)

E3S-CD11(-M1J)

E3S-CD12(-M1J)

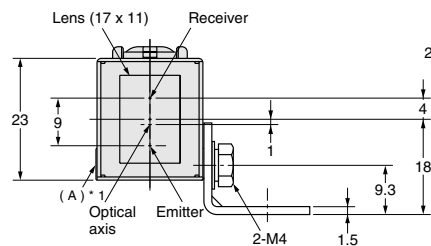
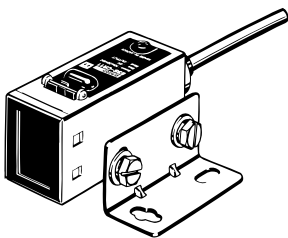

* Note: Mounting bracket can be attached to side A.

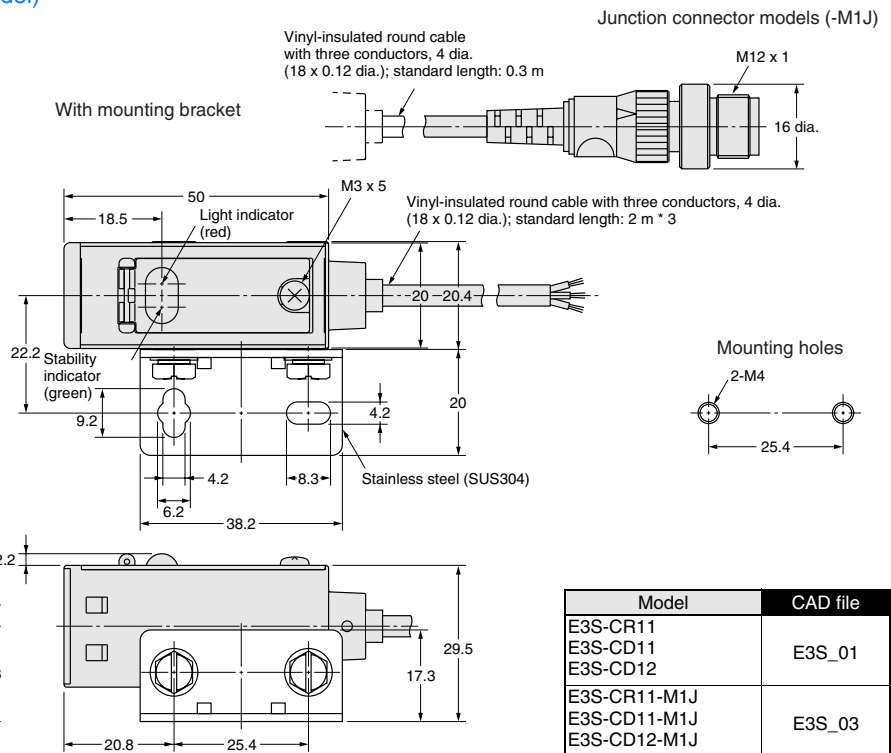

Model	CAD file
E3S-CR11	E3S_01
E3S-CD11	
E3S-CD12	
E3S-CR11-M1J	E3S_03
E3S-CD11-M1J	
E3S-CD12-M1J	

Retro/diffuse reflective model (vertical model)

E3S-CR61(-M1J)
E3S-CD61(-M1J)
E3S-CD62(-M1J)

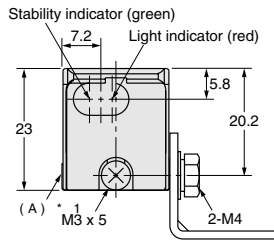
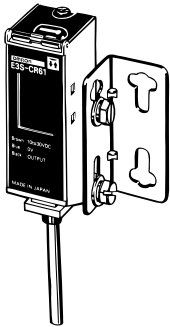

* Note: Mounting bracket can be attached to side A.

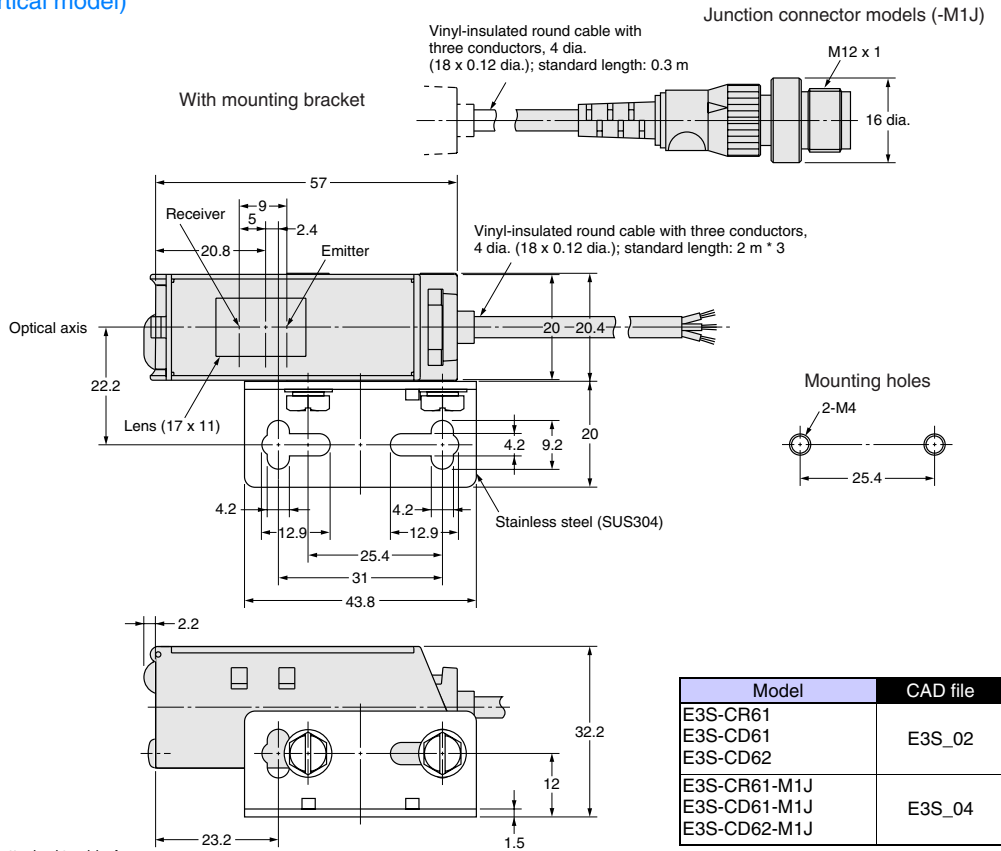

Model	CAD file
E3S-CR61	E3S_02
E3S-CD61	
E3S-CD62	
E3S-CR61-M1J	E3S_04
E3S-CD61-M1J	
E3S-CD62-M1J	

Accessories (Order Separately)

Plug-in type long slit (for through-beam model)

E39-S61

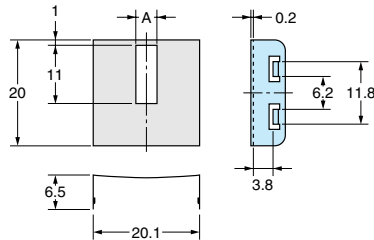
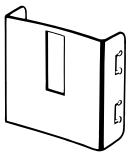

Dimension A (mm)	Material	Quantity
0.5	Stainless steel (SUS 304)	1 each for emitter and receiver (total of 8 pcs.)
1		
2		
4		