



Sensing distance	Supply voltage	Output
 (Optical fiber series)	12 to 24 VDC	 100 mA

# Optical Fiber Photoelectric Sensor

E3X

## Leading-edge Features and Long-distance Sensing in an Optical Fiber Photoelectric Sensor

### E3X-T□□ with Auto-tuning Function

Automatic Sensitivity Adjustment

### E3X-H11 High-sensitivity Model

Senses Distances Twice as Far as those of E3X-A□□ and Performs Detailed Sensing Operations Using the Variable Hysteresis Function

### E3X-A□□ Standard Model

A High-speed Response of 200 μs

### E3X-F□□ High-speed Model

Pulse Lighting Mechanism Enables a High-speed Response of 20 μs

### E3X-VG□□ Mark Sensor Model

Green Light Source Accurately Senses Subtle Differences in Color at a Speed of 200 μs



## Ordering Information

Model Number Legend:

E3X - □ □ □ □  
1 2 3 4

#### 1. Classification

- T: Auto-tuning
- H: High-sensitivity
- A: General-purpose
- F: Shorter response time
- V: For mark sensor

#### 2. Light Source

- None: Red (standard)
- G: Green

#### 3. Outputs

- 1: NPN (without self-diagnosis)
- 2: NPN (with self-diagnosis)
- 4: PNP (without self-diagnosis)
- 5: PNP (with self-diagnosis)

#### 4. Output Form

- 1: Cable

### ■ Accessories (Order Separately)

(Cannot be used with the E3X-T□□.)



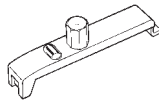
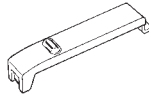



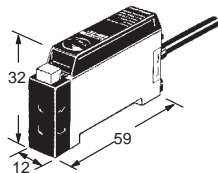
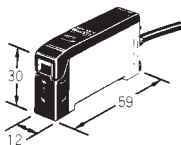

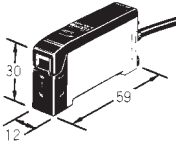
Item	Manual Sensitivity Adjustment Knob	Protective Cover
Application	Makes adjustment possible without screwdriver. Water-resistance lost when used (enclosure rating reduced to IP50).	Replacement part for cover supplied with Amplifier Unit.
Model	E39-G3	E39-G4
Appearance		

## ■ Amplifier Units

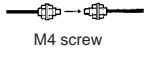
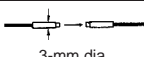

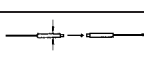
Item	Auto-tuning		High-sensitivity
Model	E3X-T11	E3X-T21	E3X-H11
Appearance			
Light source	Red LED (660 nm)		
Power supply voltage	12 to 24 VDC +10%, ripple (p-p) 10% max.		10 to 30 VDC +10%, ripple (p-p) 10% max.
Current consumption	50 mA max.		35 mA max.
Response time	500 ms max.		1 m sec max.
Control output	100 mA max. at 30 VDC, NPN open collector		
Timer function	---	OFF-delay timer (fixed to 40 ms), switch selectable	
Self-diagnosis alarm output	---	50 mA max. at 30 VDC, open collector	---
Variable hysteresis function	---		0% to 20%
Tuning monitor function	Indicator (red/green LED) and buzzer		---
Remote tuning function/ Remote bank function	---	When ON, short-circuit the blue and pink wires. (Short-circuit the blue and purple wires for remote bank selection.): Short-circuit voltage 3 V max., short-circuit current 5 mA min. When OFF, open the blue and pink wires: 9 V min. (input voltage: 24 V max.), response time 100 ms max. when OFF.	
Output method	Light ON and Dark ON selector		

Item		General-purpose		Shorter response time	For mark sensing	
Model	NPN	E3X-A11	E3X-A21	E3X-F21	E3X-VG11	E3X-VG21
	PNP	E3X-A41	E3X-A51	E3X-F51	---	---
Appearance						
Light source		Red (660 nm)			Green (565 nm)	
Power supply voltage		10 to 30 VDC ripple (p-p) 10% max.		12 to 24 VDC +10% ripple (p-p) 10% max.	10 to 30 VDC ripple (p-p) 10% max.	
Current consumption		35 mA max.		40 mA max.		
Response time		200 ms max.		ON: 20 ms max. OFF: 30 ms max.	200 ms max.	
Control output		100 mA, 30 VDC max., Open collector				
Timer function		---	OFF-delay timer (0.01 to 0.1 s; adjustable), Switch selectable		---	OFF-delay timer (0.01 to 0.1 s; adjustable), Switch selectable
Self-diagnosis alarm output		---	50 mA, 30 VDC max. Residual voltage: 1 VDC max.		---	50 mA, 30 VDC max. Residual voltage: 1 VDC max.
External diagnosis input	Input voltage	---	Light OFF: NPN: 1.5 V max; short current: 0.2 mA max. PNP: ±1.5 V max.; short current: 0.2 mA max. Light ON: NPN: Open; Light OFF: 3.5 V min. (max. input: 5 V) PNP: Open; ±3.5 VDC max. (max. input: 5 V)		---	Light OFF: 1.5 V max; short current: 0.2 mA max. Light ON: Open; 3.5 V min. (max. input: 5 V)
	Response delay		400 ms	200 ms		400 ms

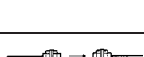
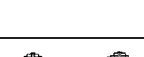
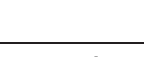
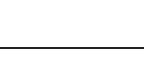
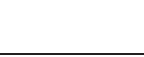
## ■ Fiber Unit Through-beam (Separate) Sensors

Model	Appearance	Sensing distance (standard object)* (T: E3X-T□□□; H: E3X-H11; A: E3X-A□□□; F: E3X-F□□□; V: E3X-VG□□□)	Min. sensing object (opaque objects)	Features
E32-T11L	 M4 screw	T: 500 mm (1,200 mm**) (1.4-mm dia. min.) H: 700 mm (2,000 mm**) (1.4-mm dia. min.) A: 350 mm (1,000 mm**) (1.4-mm dia. min.) F: 150 mm (1.4-mm dia. min.) V: 40 mm (120 mm**) (1.4-mm dia. min.)	T: 0.2-mm dia. H: 0.5-mm dia. A: 0.5-mm dia. F: 0.5-mm dia. V: 0.5-mm dia.	Long distance
E32-T12L	 3-mm dia.	T: 500 mm (1.4-mm dia. min.) H: 700 mm (1.4-mm dia. min.) A: 350 mm (1.4-mm dia. min.) F: 150 mm (1.4-mm dia. min.) V: 40 mm (1.4-mm dia. min.)	T: 0.2-mm dia. H: 0.5-mm dia. A: 0.5-mm dia. F: 0.5-mm dia. V: 0.5-mm dia.	Long distance
E32-T21L	 M3 screw	T: 150 mm (0.9-mm dia. min.) H: 200 mm (0.9-mm dia. min.) A: 100 mm (0.9-mm dia. min.) F: 50 mm (0.9-mm dia. min.) V: 10 mm (0.9-mm dia. min.)	0.2-mm dia.	Long distance with thin fiber
E32-T22L	 2-mm dia.	T: 150 mm (0.9-mm dia. min.) H: 200 mm (0.9-mm dia. min.) A: 100 mm (0.9-mm dia. min.) F: 50 mm (0.9-mm dia. min.) V: 10 mm (0.9-mm dia. min.)	0.2-mm dia.	Long distance with thin fiber
E32-TC200	 M4 screw	T: 270 mm (2,000 mm**) (1-mm dia. min.) H: 400 mm (3,000 mm**) (1-mm dia. min.) A: 200 mm (1,500 mm**) (1-mm dia. min.) F: 80 mm (1-mm dia. min.) V: 28 mm (190 mm**) (1-mm dia. min.)	0.2-mm dia.	General-purpose
E32-TC200B E32-TC200B4	 M4 screw	T: 270 mm (1-mm dia. min.) H: 400 mm (1-mm dia. min.) A: 180 mm (1-mm dia. min.) F: 80 mm (1-mm dia. min.) V: 28 mm (1-mm dia. min.)	0.2-mm dia.	General-purpose
E32-T22	 2-mm dia.	T: 70 mm (0.5-mm dia. min.) H: 100 mm (0.5-mm dia. min.) A: 50 mm (0.5-mm dia. min.) F: 26 mm (0.5-mm dia. min.) V: 7 mm (0.5-mm dia. min.)	0.2-mm dia.	General-purpose
E32-TC200E	 M3 screw	T: 70 mm (0.5-mm dia. min.) H: 100 mm (0.5-mm dia. min.) A: 50 mm (0.5-mm dia. min.) F: 26 mm (0.5-mm dia. min.) V: 8 mm (0.5-mm dia. min.)	0.2-mm dia.	General-purpose
E32-TC200F E32-TC200F4	 M3 screw	T: 70 mm (0.5-mm dia. min.) H: 100 mm (0.5-mm dia. min.) A: 50 mm (0.5-mm dia. min.) F: 26 mm (0.5-mm dia. min.) V: 8 mm (0.5-mm dia. min.)	0.2-mm dia.	General-purpose
E32-TC200A	 M3 screw	T: 250 mm (1-mm dia. min.) H: 360 mm (1-mm dia. min.) A: 180 mm (1-mm dia. min.) F: 80 mm (1-mm dia. min.) V: 28 mm (1-mm dia. min.)	T: 0.2-mm dia. H: 0.3-mm dia. A: 0.2-mm dia. F: 0.2-mm dia. V: 0.2-mm dia.	General-purpose
E32-T11	 M4 screw	T: 240 mm (1,300 mm**) (1-mm dia. min.) H: 360 mm (1-mm dia. min.) A: 180 mm (1,000 mm**) (1-mm dia. min.) F: 80 mm (1-mm dia. min.) V: 10 mm (120 mm**) (1-mm dia. min.)	T: 0.2-mm dia. H: 0.3-mm dia. A: 0.2-mm dia. F: 0.2-mm dia. V: 0.2-mm dia.	Flexible (resists breaking)
E32-T21	 M3 screw	T: 65 mm (0.5-mm dia. min.) H: 100 mm (0.5-mm dia. min.) A: 50 mm (0.5-mm dia. min.) F: 26 mm (0.5-mm dia. min.) V: 6 mm (0.5-mm dia. min.)	0.2-mm dia.	Flexible (resists breaking)

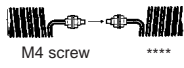
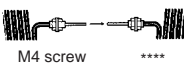
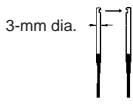
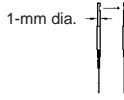
\*Standard object: opaque; \*\*For the E39-F1; \*\*\*Not trimmable

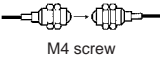
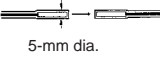
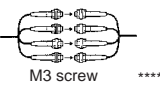
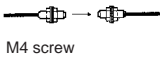
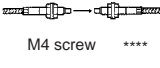
Model	Appearance	Sensing distance (standard object)* (T: E3X-T□□□; H: E3X-H11; A: E3X-A□□□; F: E3X-F□□□; V: E3X-VG□□□)	Min. sensing object (opaque objects)	Features
E32-TC200C	 M4 screw ****	T: 200 mm (800 mm**) (1-mm dia. min.) H: 300 mm (1,600 mm**) (1-mm dia. min.) A: 150 mm (800 mm**) (1-mm dia. min.) F: 60 mm (1-mm dia. min.) V: 18 mm (100 mm) (1-mm dia. min.)	0.2-mm dia.	Flexible spiral cord
E32-TC200D E32-TC200D4	 M4 screw ****	T: 200 mm (1-mm dia. min.) H: 300 mm (1-mm dia. min.) A: 150 mm (1-mm dia. min.) F: 60 mm (1-mm dia. min.) V: 18 mm (1-mm dia. min.)	0.2-mm dia.	Flexible spiral cord
E32-T14L	 3-mm dia.	T: 130 mm (1-mm dia. min.) H: 240 mm (1-mm dia. min.) A: 120 mm (1-mm dia. min.) F: 30 mm (1-mm dia. min.) V: 10 mm (1-mm dia. min.)	T: 0.3-mm dia. H: 0.2-mm dia. A: 0.1-mm dia. F: 0.2-mm dia. V: 0.1-mm dia.	Side-view; long distance
E32-T24	 1-mm dia.	T: 45 mm (0.5-mm dia. min.) H: 90 mm (0.5-mm dia. min.) A: 45 mm (0.5-mm dia. min.) F: 15 mm (0.5-mm dia. min.) V: 2 mm (0.5-mm dia. min.)	T: 0.2-mm dia. H: 0.1-mm dia. A: 0.1-mm dia. F: 0.3-mm dia. V: 0.2-mm dia.	Side-view; save space
E32-T14		T: 1,000 mm (4-mm dia. min.) H: 1,800 mm (4-mm dia. min.) A: 900 mm (4-mm dia. min.) F: 380 mm (4-mm dia. min.) V: 80 mm (4-mm dia. min.)	T: 0.2-mm dia. H: 1-mm dia. A: 1-mm dia. F: 0.2-mm dia. V: 2-mm dia.	Side-view
E32-T17L	 M4 screw	T: 7,000 mm (10-mm dia. min.) H: 14,000 mm (10-mm dia. min.) A: 7,000 mm (10-mm dia. min.) F: 3,000 mm (10-mm dia. min.) V: 800 mm (10-mm dia. min.)	T: 0.7-mm dia. H: 2.1-mm dia. A: 0.8-mm dia. F: 1.5-mm dia. V: 2.1-mm dia.	Long distance
E32-T12F	 5-mm dia.	T: 1,000 mm (4-mm dia. min.) H: 1,600 mm (4-mm dia. min.) A: 800 mm (4-mm dia. min.) F: 300 mm (4-mm dia. min.) V: 70 mm (4-mm dia. min.)	T: 0.3-mm dia. H: 0.7-mm dia. A: 0.9-mm dia. F: 0.7-mm dia. V: 0.6-mm dia.	Teflon-covered****; withstands chemicals and harsh environments
E32-M21	 M3 screw ****	T: 200 mm (2-mm dia. min.) H: 300 mm (2-mm dia. min.) A: 150 mm (2-mm dia. min.) F: 65 mm (2-mm dia. min.) V: 20 mm (2-mm dia. min.)	T: 0.2-mm dia. H: 0.4-mm dia. A: 0.3-mm dia. F: 0.3-mm dia. V: 0.3-mm dia.	4-head; 4-point sensing
E32-T51	 M4 screw	T: 300 mm (1.5-mm dia. min.) H: 400 mm (1.5-mm dia. min.) A: 200 mm (1.5-mm dia. min.) F: 80 mm (1.5-mm dia. min.) V: 20 mm (1.5-mm dia. min.)	T: 0.4-mm dia. H: 1.0-mm dia. A: 1.0-mm dia. F: 1.0-mm dia. V: 1.0-mm dia.	Heat-resistant; resists 150°C
E32-T61	 M4 screw ****	T: 180 mm (2,000 mm**) (1.0-mm dia. min.) H: 300 mm (3,000 mm**) (1.0-mm dia. min.) A: 150 mm (1,500 mm**) (1.0-mm dia. min.) F: 60 mm (450 mm) (1.0-mm dia. min.) V: 18 mm (130 mm**) (1.0-mm dia. min.)	T: 0.2-mm dia. H: 0.3-mm dia. A: 0.2-mm dia. F: 0.5-mm dia. V: 0.5-mm dia.	Heat-resistant; resists 300°C

\*Standard object: opaque; \*\*For the E39-F1.; \*\*\*Sensing distances for slit applications are in the following table.











\*\*\*\*Not trimmable









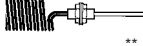

\*\*\*\*\*Teflon is a registered trademark of the Dupont Company and the Mitsui Dupont Chemical Company for their fluoride resin.

## E32-T16 with Slits

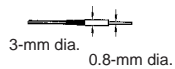
Slit width		0.5-mm	1.0-mm	Sensing method 
With E3X-T□□	Sensing distance	450 mm	800 mm	
	Min. sensing object	0.2-mm dia.	0.3-mm dia.	
With E3X-H11	Sensing distance	900 mm	1,200 mm	
	Min. sensing object	0.2-mm dia.	0.4-mm dia.	
With E3X-A□□	Sensing distance	450 mm	600 mm	
	Min. sensing object	0.25-mm dia.	0.35-mm dia.	
With E3X-F□□	Sensing distance	120 mm	250 mm	
	Min. sensing object	0.25-mm dia.	0.35-mm dia.	
With E3X-VG□□	Sensing distance	20 mm	60 mm	
	Min. sensing object	0.25-mm dia.	0.35-mm dia.	

## Reflective Sensors

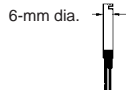
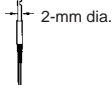





Model	Appearance 	Sensing distance (standard object) (T: E3X-T□□; H: E3X-H11; A: E3X-A□□; F: E3X-F□□; V: E3X-VG□□)		Min. sensing object (copper wire)	Features
		White paper	Black paper		
E32-D11L	 M6 screw	T: 150 mm (20 x 20 cm) H: 200 mm (20 x 20 cm) A: 100 mm (10 x 10 cm) F: 45 mm (5 x 5 cm) V: 10 mm (2.5 x 2.5 cm)	T: 40 mm (20 x 20 cm) H: 60 mm (20 x 20 cm) A: 30 mm (10 x 10 cm) F: 8 mm (5 x 5 cm) V: ---	T: 0.015-mm dia. H: 0.015-mm dia. A: 0.015-mm dia. F: 0.2-mm dia. V: 3.0-mm dia.	Long distance
E32-D12	 3 mm dia.	T: 80 mm (10 x 10 cm) H: 120 mm (20 x 20 cm) A: 60 mm (10 x 10 cm) F: 15 mm (2.5 x 2.5 cm) V: 2 mm (2.5 x 2.5 cm)	T: 20 mm (10 x 10 cm) H: 32 mm (20 x 20 cm) A: 16 mm (10 x 10 cm) F: 3 mm (2.5 x 2.5 cm) V: ---	T: 0.015-mm dia. H: 0.015-mm dia. A: 0.04-mm dia. F: 2.4-mm dia. V: 1.6-mm dia.	Long distance
E32-D21L	 M4 screw	T: 35 mm (5 x 5 cm) H: 50 mm (5 x 5 cm) A: 25 mm (2.5 x 2.5 cm) F: 11 mm (2.5 x 2.5 cm) V: 1 mm (2.5 x 2.5 cm)	T: 9 mm (5 x 5 cm) H: 14 mm (5 x 5 cm) A: 7 mm (2.5 x 2.5 cm) F: 2 mm (2.5 x 2.5 cm) V: ---	T: 0.015-mm dia. H: 0.015-mm dia. A: 0.03-mm dia. F: 0.26-mm dia. V: 1.0-mm dia.	Long distance
E32-D22L	 3 mm dia.	T: 35 mm (5 x 5 cm) H: 50 mm (5 x 5 cm) A: 25 mm (2.5 x 2.5 cm) F: 11 mm (2.5 x 2.5 cm) V: 1 mm (2.5 x 2.5 cm)	T: 9 mm (5 x 5 cm) H: 14 mm (5 x 5 cm) A: 7 mm (2.5 x 2.5 cm) F: 2 mm (2.5 x 2.5 cm) V: ---	T: 0.015-mm dia. H: 0.015-mm dia. A: 0.03-mm dia. F: 0.26-mm dia. V: 1.0-mm dia.	Long distance
E32-DC200	 M6 screw	T: 100 mm (10 x 10 cm) H: 150 mm (20 x 20 cm) A: 75 mm (10 x 10 cm) F: 33 mm (5 x 5 cm) V: 10 mm (2.5 x 2.5 cm)	T: 20 mm (10 x 10 cm) H: 30 mm (20 x 20 cm) A: 15 mm (10 x 10 cm) F: 5 mm (5 x 5 cm) V: ---	T: 0.015-mm dia. H: 0.015-mm dia. A: 0.015-mm dia. F: 0.015-mm dia. V: 0.2-mm dia.	General-purpose
E32-DC200B E32-DC200B4	 M6 screw	T: 100 mm (10 x 10 cm) H: 150 mm (20 x 20 cm) A: 75 mm (10 x 10 cm) F: 33 mm (5 x 5 cm) V: 10 mm (2.5 x 2.5 cm)	T: 20 mm (10 x 10 cm) H: 30 mm (20 x 20 cm) A: 15 mm (10 x 10 cm) F: 5 mm (5 x 5 cm) V: ---	T: 0.015-mm dia. H: 0.015-mm dia. A: 0.03-mm dia. F: 0.03-mm dia. V: 1.0-mm dia.	General-purpose
E32-DC200E	 M3 screw	T: 20 mm (2.5 x 2.5 cm) H: 36 mm (5 x 5 cm) A: 18 mm (2.5 x 2.5 cm) F: 8 mm (2.5 x 2.5 cm) V: 2 mm (2.5 x 2.5 cm)	T: 4.8 mm (2.5 x 2.5 cm) H: 7.2 mm (5 x 5 cm) A: 3.6 mm (2.5 x 2.5 cm) F: 1.5 mm (2.5 x 2.5 cm) V: ---	T: 0.015-mm dia. H: 0.015-mm dia. A: 0.03-mm dia. F: 0.03-mm dia. V: 1.0-mm dia.	General-purpose
E32-DC200F E32-DC200F4	 M3 screw	T: 20 mm (2.5 x 2.5 cm) H: 36 mm (5 x 5 cm) A: 18 mm (2.5 x 2.5 cm) F: 8 mm (2.5 x 2.5 cm) V: 2 mm (2.5 x 2.5 cm)	T: 4.8 mm (2.5 x 2.5 cm) H: 7.2 mm (5 x 5 cm) A: 3.6 mm (2.5 x 2.5 cm) F: 1.5 mm (2.5 x 2.5 cm) V: ---	T: 0.015-mm dia. H: 0.015-mm dia. A: 0.03-mm dia. F: 0.03-mm dia. V: 1.0-mm dia.	General-purpose
E32-D11	 M6 screw	T: 60 mm (10 x 10 cm) H: 90 mm (10 x 10 cm) A: 45 mm (5 x 5 cm) F: 20 mm (2.5 x 2.5 cm) V: 7 mm (2.5 x 2.5 cm)	T: 13 mm (10 x 10 cm) H: 20 mm (10 x 10 cm) A: 10 mm (5 x 5 cm) F: 5 mm (2.5 x 2.5 cm) V: ---	T: 0.015-mm dia. H: 0.015-mm dia. A: 0.03-mm dia. F: 0.03-mm dia. V: 0.5-mm dia.	Flexible (resists breaking)

Model	Appearance	Sensing distance (standard object) (T: E3X-T□□; H: E3X-H11; A: E3X-A□□; F: E3X-F□□; V: E3X-VG□□)		Min. sensing object (copper wire)	Features
		White paper	Black paper		
E32-D21	 M3 screw	T: 8 mm (2.5 x 2.5 cm) H: 14 mm (2.5 x 2.5 cm) A: 7 mm (2.5 x 2.5 cm) F: 3 mm (2.5 x 2.5 cm) V: 1 mm (2.5 x 2.5 cm)	T: 1.6 mm (2.5 x 2.5 cm) H: 3 mm (2.5 x 2.5 cm) A: 1.5 mm (2.5 x 2.5 cm) F: --- V: ---	T: 0.015-mm dia. H: 0.015-mm dia. A: 0.03-mm dia. F: 0.03-mm dia. V: 1.0-mm dia.	Flexible (resists breaking)
E32-DC200C	 M6 screw **	T: 30 mm (5 x 5 cm) H: 44 mm (5 x 5 cm) A: 22 mm (2.5 x 2.5 cm) F: 10 mm (2.5 x 2.5 cm) V: 2.5 mm (2.5 x 2.5 cm)	T: 6 mm (5 x 5 cm) H: 10 mm (5 x 5 cm) A: 4.5 mm (2.5 x 2.5 cm) F: --- V: ---	T: 0.015-mm dia. H: 0.015-mm dia. A: 0.03-mm dia. F: 0.03-mm dia. V: 1.0-mm dia.	Flexible spiral cord
E32-DC200D E32-DC200D4	 M6 screw **	T: 30 mm (5 x 5 cm) H: 44 mm (5 x 5 cm) A: 22 mm (2.5 x 2.5 cm) F: 10 mm (2.5 x 2.5 cm) V: 2.5 mm (2.5 x 2.5 cm)	T: 6 mm (5 x 5 cm) H: 10 mm (5 x 5 cm) A: 4.5 mm (2.5 x 2.5 cm) F: --- V: ---	T: 0.015-mm dia. H: 0.015-mm dia. A: 0.03-mm dia. F: 0.03-mm dia. V: 1.0-mm dia.	Flexible spiral cord
E32-DC9G E32-DC9G4	 1.2-mm dia. **	T: 35 mm (5 x 5 cm) H: 60 mm (10 x 10 cm) A: 30 mm (5 x 5 cm) F: 9 mm (2.5 x 2.5 cm) V: 2.5 mm (2.5 x 2.5 cm)	T: 7 mm (5 x 5 cm) H: 12 mm (10 x 10 cm) A: 6 mm (5 x 5 cm) F: 1.5 mm (2.5 x 2.5 cm) V: ---	T: 0.015-mm dia. H: 0.015-mm dia. A: 0.03-mm dia. F: 0.03-mm dia. V: 1.0-mm dia.	Stainless steel sleeve
E32-D33	 3-mm dia. 0.8-mm dia.	T: 6 mm (2.5 x 2.5 cm) H: 10 mm (2.5 x 2.5 cm) A: 5 mm (2.5 x 2.5 cm) F: 1.8 mm (2.5 x 2.5 cm) V: ---	T: 1.3 mm (2.5 x 2.5 cm) H: 2 mm (2.5 x 2.5 cm) A: --- F: --- V: ---	T: 0.015-mm dia. H: 0.015-mm dia. A: 0.015-mm dia. F: 0.03-mm dia. V: ---	Super-thin; detail sensing
E32-CC200	 M6 screw	T: 100 mm (10 x 10 cm) H: 150 mm (20 x 20 cm) A: 75 mm (10 x 10 cm) F: 33 mm (5 x 5 cm) V: 10 mm (2.5 x 2.5 cm)	T: 20 mm (10 x 10 cm) H: 30 mm (20 x 20 cm) A: 15 mm (10 x 10 cm) F: 6 mm (5 x 5 cm) V: 2 mm (2.5 x 2.5 cm)	T: 0.015-mm dia. H: 0.015-mm dia. A: 0.03-mm dia. F: 0.03-mm dia. V: 0.5-mm dia.	Coaxial; positioning accuracy
E32-D32	 2-mm dia.	T: 30 mm (2.5 x 2.5 cm) H: 40 mm (5 x 5 cm) A: 20 mm (2.5 x 2.5 cm) F: 9 mm (2.5 x 2.5 cm) V: 2.5 mm (2.5 x 2.5 cm)	T: 5.3 mm (2.5 x 2.5 cm) H: 8 mm (5 x 5 cm) A: 4 mm (2.5 x 2.5 cm) F: 1.5 mm (2.5 x 2.5 cm) V: ---	T: 0.015-mm dia. H: 0.015-mm dia. A: 0.03-mm dia. F: 0.03-mm dia. V: 0.5-mm dia.	General-purpose
E32-D32L	 3-mm dia.	T: 60 mm (10 x 10 cm) H: 80 mm (10 x 10 cm) A: 40 mm (5 x 5 cm) F: 11 mm (2.5 x 2.5 cm) V: 4 mm (2.5 x 2.5 cm)	T: 10 mm (10 x 10 cm) H: 16 mm (10 x 10 cm) A: 8 mm (5 x 5 cm) F: 4 mm (2.5 x 2.5 cm) V: ---	T: 0.015-mm dia. H: 0.015-mm dia. A: 0.04-mm dia. F: 1.1-mm dia. V: 1-mm dia.	General-purpose
E32-D14L	 6-mm dia.	T: 40 mm (5 x 5 cm) H: 40 mm (5 x 5 cm) A: 40 mm (5 x 5 cm) F: 12 mm (2.5 x 2.5 cm) V: 1.5 mm (2.5 x 2.5 cm)	T: 8 mm (5 x 5 cm) H: 8 mm (5 x 5 cm) A: 8 mm (5 x 5 cm) F: 2 mm (2.5 x 2.5 cm) V: ---	T: 0.03-mm dia. H: 0.03-mm dia. A: 0.03-mm dia. F: 0.5-mm dia. V: 1.0-mm dia.	Side-view; long distance
E32-D24	 2-mm dia.	T: 15 mm (2.5 x 2.5 cm) H: 15 mm (2.5 x 2.5 cm) A: 15 mm (2.5 x 2.5 cm) F: 4 mm (2.5 x 2.5 cm) V: 1.6 mm (2.5 x 2.5 cm)	T: 2.5 mm (2.5 x 2.5 cm) H: 2.5 mm (2.5 x 2.5 cm) A: 2.5 mm (2.5 x 2.5 cm) F: --- V: ---	T: 0.03-mm dia. H: 0.03-mm dia. A: 0.03-mm dia. F: 0.03-mm dia. V: 1.0-mm dia.	Side-view; save space
E32-D12F	 6-mm dia.	T: 50 mm (5 x 5 cm) H: 50 mm (5 x 5 cm) A: 50 mm (5 x 5 cm) F: 20 mm (2.5 x 2.5 cm) V: 4 mm (2.5 x 2.5 cm)	T: 15 mm (5 x 5 cm) H: 15 mm (5 x 5 cm) A: 15 mm (5 x 5 cm) F: 6 mm (2.5 x 2.5 cm) V: ---	T: 0.03-mm dia. H: 0.03-mm dia. A: 0.03-mm dia. F: 0.5-mm dia. V: 0.5-mm dia.	Teflon-covered***; withstands chemicals and harsh environments

\*Standard object: opaque

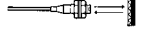
\*\*Not trimmable

\*\*\*Teflon is a registered trademark of the Dupont Company and the Mitsui Dupont Chemical Company for their fluoride resin.

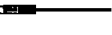
Model	Appearance	Sensing distance (standard object) (T: E3X-T□□; H: E3X-H11; A: E3X-A□□; F: E3X-F□□; V: E3X-VG□□)		Min. sensing object (copper wire)	Features
		White paper	Black paper		
E32-D51	 M6 screw	T: 60 mm (10 x 10 cm) H: 120 mm (20 x 20 cm) A: 60 mm (10 x 10 cm) F: 26 mm (5 x 5 cm) V: 5 mm (2.5 x 2.5 cm)	T: 12 mm (10 x 10 cm) H: 24 mm (20 x 20 cm) A: 12 mm (10 x 10 cm) F: 5 mm (5 x 5 cm) V: ---	T: 0.03-mm dia. H: 0.03-mm dia. A: 0.03-mm dia. F: 0.03-mm dia. V: 1.0-mm dia.	Heat-resistive; resists 150°C
E32-D61	 M6 screw **	T: 45 mm (5 x 5 cm) H: 45 mm (5 x 5 cm) A: 45 mm (5 x 5 cm) F: 20 mm (2.5 x 2.5 cm) V: 5 mm (2.5 x 2.5 cm)	T: 9 mm (5 x 5 cm) H: 9 mm (5 x 5 cm) A: 9 mm (5 x 5 cm) F: 4 mm (2.5 x 2.5 cm) V: ---	T: 0.03-mm dia. H: 0.03-mm dia. A: 0.03-mm dia. F: 0.03-mm dia. V: 1.0-mm dia.	Heat-resistive; resists 300°C
E32-D73	 M4 screw 1.25-mm dia. **	T: 30 mm (5 x 5 cm) H: 30 mm (5 x 5 cm) A: 30 mm (5 x 5 cm) F: 17 mm (2.5 x 2.5 cm) V: 3 mm (2.5 x 2.5 cm)	T: 6 mm (5 x 5 cm) H: 6 mm (5 x 5 cm) A: 6 mm (5 x 5 cm) F: 3 mm (2.5 x 2.5 cm) V: ---	T: 0.03-mm dia. H: 0.03-mm dia. A: 0.03-mm dia. F: 0.2-mm dia. V: 1.0-mm dia.	Heat-resistive; resists 400°C
E32-R21 /E39-R3	 M6 screw Reflector E39-R3	T: 25 to 250 mm (35-mm dia. min.) H: 10 to 250 mm (35-mm dia. min.) A: 10 to 250 mm (35-mm dia. min.) F: 20 to 230 mm (35-mm dia. min.) V: ---	---	T: 0.6-mm dia. H: 0.3-mm dia. A: 0.3-mm dia. F: 0.5-mm dia. V: ---	Transparent objects sensing
E32-R16 /E39-R1	 Reflector E39-R1	T: 150 to 1,500 mm (35-mm dia. min.) H: 150 to 1,500 mm (35-mm dia. min.) A: 150 to 1,500 mm (35-mm dia. min.) F: 50 to 700 mm (35-mm dia. min.) V: ---	---	T: 1.9-mm dia. H: 0.6-mm dia. A: 0.6-mm dia. F: 0.6-mm dia. V: ---	Transparent objects sensing
E32-L25		T: 3.3 mm (2.5 x 2.5 cm) H: 3.3 mm (2.5 x 2.5 cm) A: 3.3 mm (2.5 x 2.5 cm) F: 3.3 mm (2.5 x 2.5 cm) V: ---	---	T: 0.015-mm dia. H: 0.015-mm dia. A: 0.03-mm dia. F: 0.5-mm dia. V: ---	Limited reflective; senses wafers and small difference in height
E32-L25A		T: 3.3 mm (2.5 x 2.5 cm) H: 3.3 mm (2.5 x 2.5 cm) A: 3.3 mm (2.5 x 2.5 cm) F: 3.3 mm (2.5 x 2.5 cm) V: ---	---	T: 0.015-mm dia. H: 0.015-mm dia. A: 0.03-mm dia. F: 0.5-mm dia. V: ---	Limited reflective; senses wafers and small difference in height
E32-L25L		H: 7.2±1.8 mm (2.5 x 2.5 cm) A: 7.2±1.8 mm (2.5 x 2.5 cm) F: 7.2±1.0 mm (2.5 x 2.5 cm)	---	H: 0.015-mm dia. A: 0.015-mm dia. F: 0.015-mm dia.	Limited reflective, long distance; senses wafers and small difference in height
E32-L24L		H: 4±2 mm (2.5 x 2.5 cm) A: 4±2 mm (2.5 x 2.5 cm) F: 4±2 mm (2.5 x 2.5 cm)	---	H: 0.015-mm dia. A: 0.015-mm dia. F: 0.015-mm dia.	Limited reflective, long distance, side-view; senses wafers and small difference in height

\*Standard object: opaque

\*\*Not trimmable

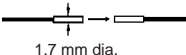
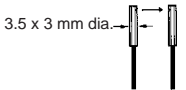
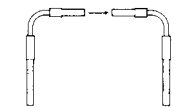

## Fine Through-beam

Model	Appearance	Sensing distance (standard object)*	Min. sensing object (opaque objects)	Features
E32-T22S		H: 1,000 mm (1.7-mm dia. min.) T: 650 mm (1.7-mm dia. min.)	H: 0.5-mm dia. T: 0.4-mm dia.	General purpose
E32-T24S		H: 700 mm (1.7-mm dia. min.) T: 450 mm (1.7-mm dia. min.)	H: 0.5-mm dia. T: 0.4-mm dia.	Side-view
E32-T84S		H: 700 mm (1.7-mm dia. min.)	H: 0.4-mm dia.	Sensing the wafers in cassettes (Fine, long beam sensor resisting 200°C)

\*Use the E32-T22S and E32-T24S in combination with the E3X-H11, E3X-T11, or E3X-T21 Amplifier for stable wafer sensing.

## Slot Sensors

Model	Appearance	Sensing distance (standard object)*	Min. sensing object (opaque objects)	Features
E32-G14		10 mm (slot width) (4-mm dia. min.)	T: 0.7-mm dia. H: 1.0-mm dia. A: 0.5-mm dia. F: 0.6-mm dia. V: 0.6-mm dia.	Slot through-beam; no optical axis adjustment required

\*Standard object: opaque

## Liquid Level Fiber Unit

## Liquid Contact Model

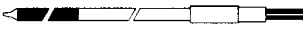
Model	Appearance	Standard sensing object	Sensing object angle range	Repeat frequency	Applicable Amplifier Unit (see note)
E32-D82F1		Pure water at a temperature of 25°C.	±10° max.	0.5 mm max.	E3X-NT/NM E3X-NV E3X-H
E32-D82F2					

**Note:** When using the E32-D82F1 or E32-D82F2 with the E3X-A, cut the plastic fiber part to 0.5 m, otherwise the energy of the light received by the E3X-A will be insufficient.

## Pipe Mounting Model

Model	Appearance	Standard sensing object	Repeat frequency	Applicable Amplifier Unit
E32-L25T		Liquid (Non-transparent liquids may not be sensed)	1 mm max.	E3X-NT/NM E3X-A/H

## High-precision Screen Sensors

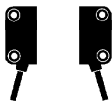
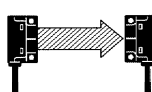
Model	Appearance	Slit width	Sensing distance (H: E3X-H11; A: E3X-A□□; F: E3X-F□□; V: E3X-VG□□)	Min. sensing object* (horizontal beam)
E32-T16P		Not used	H: 600 mm A: 300 mm	H: 1.3-mm dia. (1.1-mm dia.) A: 2.0-mm dia. (0.9-mm dia.)
		0.5 mm wide	H: 100 mm A: 50 mm	H: 1.3-mm dia. (0.4-mm dia.) A: 2.0-mm dia. (0.7-mm dia.)
		1.0 mm wide	H: 200 mm A: 100 mm	H: 1.3-mm dia. (0.6-mm dia.) A: 2.0-mm dia. (0.8-mm dia.)
E32-T16		Not used	H: 1,500 mm A: 750 mm F: 330 mm V: 150 mm	H: 6.0-mm dia. A: 6.0-mm dia. F: 7.0-mm dia. V: 7.0 mm dia.
		0.5 mm wide	H: 900 mm A: 450 mm F: 120 mm V: 20 mm	H: 5.0-mm dia. A: 5.0-mm dia. F: 7.0-mm dia. V: 7.0-mm dia.
		1.0 mm wide	H: 1,200 mm A: 600 mm F: 250 mm V: 60 mm	H: 6.0-mm dia. A: 6.0-mm dia. F: 7.0-mm dia. V: 7.0-mm dia.

\* Values not in parentheses represent sensing objects within the 11-mm sensing area and values in parentheses represent sensing objects in the center of the E32-T16P sensing area. The diameters of sensing objects in the above table represent sensing object sizes, on condition that the objects are not moving.

## Sensing Direction

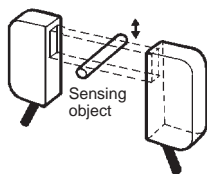

## Specifications

## Amplifier Units

Indicator	Light indicator (red), Stability indicator (green)
Sensitivity adjuster	8 turns with indicator (except E3X-T□□)
Circuit protection	Reverse polarity, Output short-circuit
Ambient temperature	Operating: -25°C to 55°C (with no icing) Storage: -40°C to 70°C
Ambient humidity	35% to 85% (with no condensation)
Ambient illumination	Sunlight: 10,000 lx max.; Incandescent lamp: 3,000 lx max.
Insulation resistance	20 MW min. (at 500 VDC)
Dielectric strength	1,000 VAC, 50/60 Hz for 1 min
Enclosure rating	IEC IP66 (with protective cover in place) (see note)
Material	Case: Heat-resistive ABS; Cover: Polycarbonate
Connection method	Cord-drawing method
Weight (with 2-m cord)	Approx. 100 g

**Note:** The enclosure rating is IP50 without the protection cover.

## Fiber Unit

## Through-beam (Separate) Sensors

Model	Ambient temperature	Ambient humidity	Permissible bending radius	Material	Enclosure rating
E32-T11L	Operating: -40°C to 70°C (with no icing)	Operating: 35% to 85%	25 mm min.	Black polyethylene	IEC IP67
E32-T12L					
E32-T21L					
E32-T22L					
E32-TC200					
E32-TC200B					
E32-TC200B4					
E32-T22					
E32-TC200E					
E32-TC200F					
E32-TC200F4					
E32-TC200A					
E32-T11			4 mm min.	Vinyl chloride	
E32-T21			25 mm min.	Black polyethylene	
E32-TC200C					
E32-TC200D					
E32-TC200D4					
E32-T14L					
E32-T24					
E32-T14					
E32-T17L					
E32-T12F	Operating: -30°C to 70°C (with no icing)		40 mm min.	Teflon-covered black polyethylene	
E32-M21	Operating: -40°C to 70°C (with no icing)		25 mm min.	Black polyethylene	
E32-T51	Operating: -40°C to 150°C* (with no icing)		35 mm min.	Fluoride resin	
E32-T61	Operating: -40°C to 300°C (with no icing)		25 mm min.	SUS	

\*When used continuously between -40°C and 130°C.

## Reflective Sensors

Model	Differential travel	Ambient temperature	Ambient humidity	Permissible bending radius	Material	Enclosure rating
E32-D11L	20% of max. of sensing distance (Adjustable in a range of 0% to 20% when the E3X-H11 is used.)	Operating: -40°C to 70°C (with no icing)	Operating: 35% to 85%	25 mm min.	Black polyethylene	IEC IP67
E32-D12						
E32-D21L						
E32-D22L						
E32-DC200						
E32-DC200B						
E32-DC200B4						
E32-DC200E						
E32-DC200F						
E32-DC200F4						
E32-D11				4 mm min.	Vinyl chloride	
E32-D21				25 mm min.	Black polyethylene	
E32-DC200C						
E32-DC200D						
E32-DC200D4						
E32-DC9G						
E32-DC9G4						
E32-D33						
E32-CC200						
E32-D32	40 mm min.	Teflon-covered black polyethylene*				
E32-D32L						
E32-D14L	35 mm min.	Fluoride resin				
E32-D24						
E32-D12F	Operating: -30°C to 70°C (with no icing)	25 mm min.	SUS			
E32-D51	Operating: -40°C to 150°C (with no icing)**					
E32-D61	Operating: -40°C to 300°C (with no icing)	Black polyethylene	IEC IP66			
E32-D73	Operating: -40°C to 400°C (with no icing)					
E32-R21	Operating: -40°C to 70°C (with no icing)	Reinforced polyethylene	IEC IP50			
E32-R3						
E32-R16	Operating: -25°C to 55°C (with no icing)	10 mm min. (average at 10% decrease of sensing distance)	Reinforced polyethylene			
E32-L25	Operating: -40°C to 70°C (with no icing)					
E32-L25A	Operating: -40°C to 105°C (with no icing)					
E32-L25L***						
E32-L24L***						

\*Teflon is a registered trademark of the Dupont Company and the Mitsui Dupont Chemical Company for their fluoride resin.

\*\*When used continuously between -40°C and 130°C.

\*\*\*Beam size: 2 mm dia.

## Fine Through-beam Sensors

Model	Beam size	Differential travel	Horizontal positioning accuracy	Ambient temperature	Ambient humidity	Permissible bending radius*	Material	Enclosure rating
E32-T22S	13 mm dia. (at a distance of 200 mm)	---	---	Operating: -40°C to 70°C (with no icing)	Operating: 35% to 85%	10 mm min.	Reinforced laminated vinyl chloride	IEC IP67
E32-T24S				Operating: -40°C to 200°C (with no icing)		25 mm min.	SUS	
E32-T84S								

\*Average at 30% of sensing distance

## Slot Sensors

Model	Ambient temperature	Ambient humidity	Permissible bending radius	Material	Enclosure rating
E32-G14	Operating: -40°C to 70°C (with no icing)	Operating: 35% to 85%	25 mm min.	Black polyethylene	IEC IP67

## Liquid Contact Model

Model	Differential travel	Ambient temperature	Ambient humidity	Ambient pressure	Permissible bending radius* (average at 10% of sensing distance)	Material	Enclosure rating
E32-D82F1	3.0 mm max.	Teflon part within 1.5 m of fiber tip: -40°C to 200°C (with no icing)	Operating: 35% to 85%	-50 kpa (-0.49 kgf/cm <sup>2</sup> ) to 500 kpa (4.9 kgf/cm <sup>2</sup> )	40 mm min. (plastic fiber: 25 mm min.) Bending-prohibited part: E32-D82F1: Within 150 mm of fiber tip E32-D82F2: Within 350 mm of fiber tip	Sensing head: Teflon* (PFA) Fiber sheath: Black polyethylene Connector: Nickel-coated brass	IEC IP68**
E32-D82F2		Parts other than above: -40°C to 85°C (with no icing)					

\*The teflon part located 10 cm underwater must not generate air bubbles when air is injected into the teflon part with a pressure of 98 kpa (1 kgf/cm<sup>2</sup>).

\*\*Teflon is a registered trademark of the Dupont Company and the Mitsui Dupont Chemical Company for their fluoride resin.



## Pipe Mounting Model

Model	Suitable pipe	Pipe material	Ambient temperature	Ambient humidity	Permissible bending radius	Material	Enclosure rating
E32-L25T	Transparent pipes with an outer diameter of 8 to 10 mm and an inner diameter of 6 to 8 mm	FEP transparent pipes or equivalent	Operating: -40°C to 70°C (with no icing)	Operating: 35% to 85%	10 mm min.	Sensing head: Polycarbonate Fiber: Polyethylene-covered plastic	IEC IP50

## High-precision Screen Sensors

Model	Ambient temperature	Ambient humidity	Permissible bending radius	Material	Enclosure rating
E32-T16P	Operating: -40°C to 70°C (with no icing)	Operating: 35% to 85%	R10 mm min.	Sensing head: Heat-resistant ABS Fiber sheath: Vinyl chloride	IEC IP50
E32-T16			25 mm min.	Sensing head: Heat-resistant ABS Sensing surface: PMMA Fiber sheath: Black polyethylene	IEC IP67

## Attachments

Name		Small Spot Lens Unit	Long Distance Lens Unit			
Applications		Sensing over 0.5-mm-dia. spots	Increasing sensing distance			
Model		E39-F3A	E39-F1			
Appearance		Reflective 	Through-beam (separate) 			
Applicable fibers		E32-D32	E32-T11L	E32-TC200 E32-T61	E32-T11	E32-TC200C
With E3X-T□□	Sensing distance	20 mm	1,200 mm	2,000 mm	1,300 mm	800 mm
	Standard object	White paper 2.5 x 2.5 cm	Opaque objects: 4-mm dia. min.			
With E3X-H11	Sensing distance	20 mm	2,000 mm	3,000 mm	2,000 mm	1,600 mm
	Standard object	White paper 2.5 x 2.5 cm	Opaque objects: 4-mm dia. min.			
With E3X-A□□	Sensing distance	20 mm	1,000 mm	1,500 mm	1,000 mm	800 mm
	Standard object	White paper 2.5 x 2.5 cm	Opaque objects: 4-mm dia. min.			
With E3X-F□□	Sensing distance	16 mm	550 mm	670 mm*	400 mm	350 mm
	Standard object	White paper 2.5 x 2.5 cm	Opaque objects: 4-mm dia. min.			
With E3X-VG□□	Sensing distance	---	120 mm	190 mm**	120 mm	100 mm
	Standard object	---	Opaque objects: 4-mm dia. min.			
Directivity		---	5° to 40°			
Differential travel		20% of sensing distance	---			
Ambient temperature		Operating: -40°C to 70°C	Operating: -40°C to 200°C (Do not exceed the operating temperature of the fiber.)			
Material	Shaft	Aluminum	Brass			
	Lens	Optical glass				
	Base	---				
	Reflector	---				

\*E32-T6: 450 mm.



\*\*E32-T6: 130 mm.

Name		Side-view Unit			
Applications		Changing the sensing direction at 90°			
Model		E39-F2			
Appearance		Through-beam (separate) 			
Applicable fibers		E32-T11L	E32-TC200	E32-T61/11	E32-TC200C
With E3X-T□□	Sensing distance	250 mm	250 mm	200 mm	100 mm
	Standard object	Opaque objects: 3-mm dia. min.			
With E3X-H11	Sensing distance	400 mm	500 mm	400 mm	200 mm
	Standard object	Opaque objects: 3-mm dia. min.			
With E3X-A□□	Sensing distance	200 mm	250 mm	200 mm	100 mm
	Standard object	Opaque objects: 3-mm dia. min.			
With E3X-F□□	Sensing distance	60 mm	100 mm	60 mm	30 mm
	Standard object	Opaque objects: 3-mm dia. min.			
With E3X-VG□□	Sensing distance	10 mm	19 mm	10 mm	6 mm
	Standard object	Opaque objects: 4-mm dia. min.	Opaque objects: 3-mm dia. min.		
Directivity		20° to 60°			
Differential travel		---			
Ambient temperature		Operating: -40°C to 200°C (Do not exceed the operating temperature of the fiber.)			
Material	Shaft	Brass			
	Lens	Optical glass			
	Base	---			
	Reflector	---			

Name			Lens-equipped Reflective Unit		
Applications			Converting through-beam sensors to reflective sensors		
Model			E39-F3		
Appearance			Reflective 		
Applicable fibers			E32-T11L	E32-TC200	E32-T61
With E3X-T□□	Sensing distance (standard object)	White paper	55 to 150* mm (20 x 20 cm)	85 to 100 mm (20 x 20* cm)	
		Black paper	---	15 to 17*mm (20 x 20 cm)	16 to 18*mm (20 x 20 cm)
With E3X-H11	Sensing distance (standard object)	White paper	10 to 300 mm (20 x 20 cm)	35 to 180 mm (20 x 20 cm)	
		Black paper	---	5 to 120 mm (20 x 20 cm)	5 to 80 mm (20 x 20 cm)
With E3X-A□□	Sensing distance (standard object)	White paper	10 to 150 mm (20 x 20 cm)	35 to 90 mm (10 x 10 cm)	
		Black paper	---	5 to 60 mm (10 x 10 cm)	5 to 40 mm (10 x 10 cm)
With E3X-F□□	Sensing distance (standard object)	White paper	10 to 65 mm (10 x 10 cm)	20 to 40 mm (5 x 5 cm)	20 to 35 mm (5 x 5 cm)
		Black paper	---	10 to 20 mm (5 x 5 cm)	---
With E3X-VG□□	Sensing distance (standard object)	White paper	---	10 to 15 mm (2.5 x 2.5 cm)	---
		Black paper	---	---	---
Directivity			---		
Differential travel			20% of sensing distance		
Ambient temperature			Operating: -40°C to 200°C (Do not exceed the operating temperature of the fiber.)		
Material	Shaft		Brass		
	Lens		Optical glass		
	Base		Aluminum		
	Reflector		---		

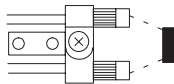
\*These values are possible when the angle of the E39-F3 is smallest (parallel).



Name		Lens-equipped Reflective Unit		Side-view Reflective Unit
Applications		Converting through-beam sensors to reflective sensors		Converting through-beam to reflective sensor
Model		E39-F3		E39-F5
Appearance		Reflective 		Reflective 
Applicable fibers		E32-T11	E32-TC200C	E32-TC200A
With E3X-T□□	Sensing distance (standard object)	White paper	90 to 100* mm (20 x 20 cm)	85 to 100* mm (20 x 20 cm)
		Black paper	---	
With E3X-H11	Sensing distance (standard object)	White paper	35 to 180 mm (20 x 20 cm)	
		Black paper	5 to 70 mm (20 x 20 cm)	10 to 60 mm (20 x 20 cm)
With E3X-A□□	Sensing distance (standard object)	White paper	35 to 90 mm (10 x 10 cm)	
		Black paper	5 to 35 mm (10 x 10 cm)	10 to 30 mm (10 x 10 cm)
With E3X-F□□	Sensing distance (standard object)	White paper	20 to 40 mm (5 x 5 cm)	20 to 35 mm (5 x 5 cm)
		Black paper	---	
With E3X-VG□□	Sensing distance (standard object)	White paper	---	
		Black paper	---	
Directivity		---		
Differential travel		20% of sensing distance		
Ambient temperature		Operating: -40°C to 200°C (Do not exceed the operating temperature of the fiber.)		Operating: -40°C to 70°C
Material	Shaft	Brass		---
	Lens	Optical glass		---
	Base	Aluminum		Brass
	Reflector	---		Stainless

\*These values are possible when the angle of the E39-F3 is smallest (parallel).

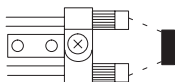

### Beam Spot Characteristics E39-F3A

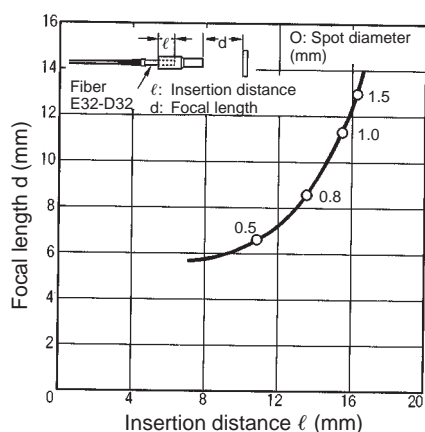





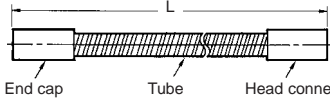

## Spiral Tubes

Model	E39-F32A5	E39-F32A	E39-F32B5	E39-F32B	E39-F32C5	E39-F32C	E39-F32D5	E39-F32D
Appearance								
Length (L)	500 mm	1,000 mm	500 mm	1,000 mm	500 mm	1,000 mm	500 mm	1,000 mm
Applicable fiber	E32-DC200E E32-DC200F(4) E32-D21		E32-TC200E E32-TC200F(4) E32-T21 E32-T21L		E32-TC200 E32-TC200B(4) E32-T11 E32-T51 E32-T11L		E32-DC200 E32-DC200B(4) E32-CC200 E32-D11 E32-D51 E32-D11L	
Ambient temperature	Operating: -40°C to 150°C (Do not exceed the operating temperature of the fiber)							
Ambient humidity	Operating: 35% to 85%							
Permissible bending radius	R: 30 mm min.							
Tensile strength	Between head connector and end cap with tube: 15 kgf \$ cm max. (1.5 N \$ m) Tube: 20 kgf \$ cm max. (2 N \$ m)							
Compression load	Tube: 3 kg max. (29.4 N)							

## Accessories

Name	Fiber Cutter	Fine-fiber Attachment	Fiber Connector	Sleeve Bender
Model	E39-F4	E39-F9	E39-F10	E39-F11
Appearance				
Features	Used to cut fibers to desired lengths	Used when inserting fine fibers into the amp	Used to connect fibers when broken	Used to bend fiber sleeves
Applicable fiber	All models equipped with trimmable fibers	E32-DC200E, -TC200E E32-DC200F(4), -TC200F(4) E32-D21, -D21L, -D22L E32-T21, -T21L, -T22L E32-D32, -T22 E32-D24, -T24 E32-D33 E32-R21	E32-DC200, -TC200 E32-DC200B(4), -TC200B(4) E32-TC200A E32-T14, -G14 E32-D11L, -T11L, -T12L E32-D14L, -T14L E32-T17L	E32-TC200B(4) E32-TC200D(4) E32-DC200F(4), -TC200F(4) E32-DC9G(4)

# Engineering Data

## ■ Excess Gain Ratio

E3X-T□□

**E32-TC200**

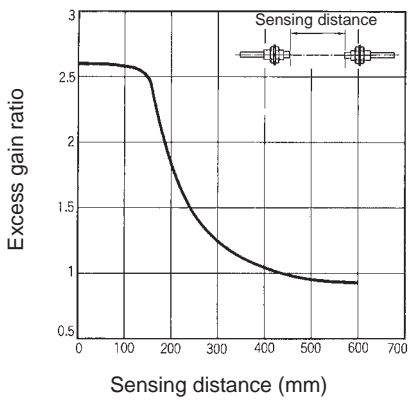

**E32-T11L**

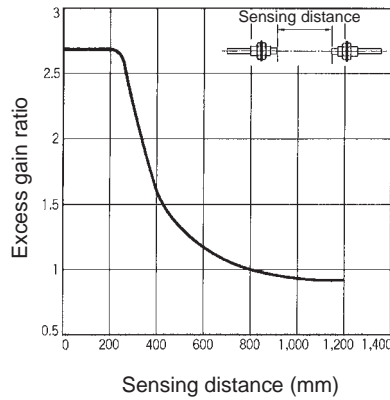

**E32-T11L + E39-F1**

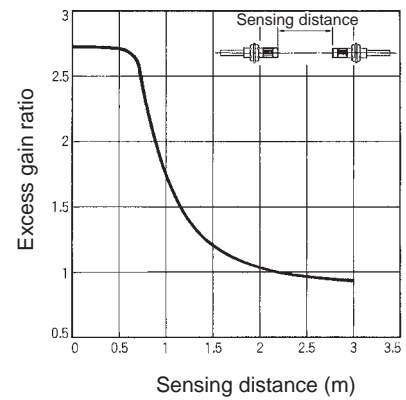

**E32-T11L + E39-F2**

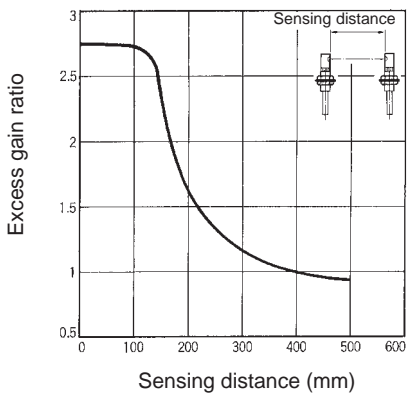

**E32-T11L + E39-F3**

(When the angle of the E39-F3 is at its minimum (parallel).)

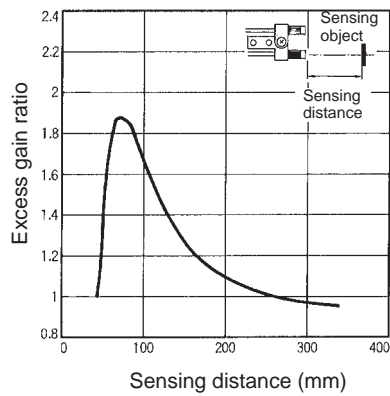

**E32-T21L**

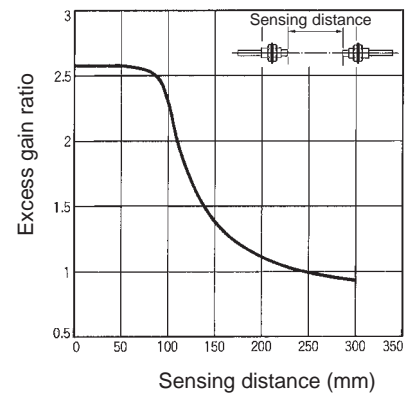

**E32-T14L**

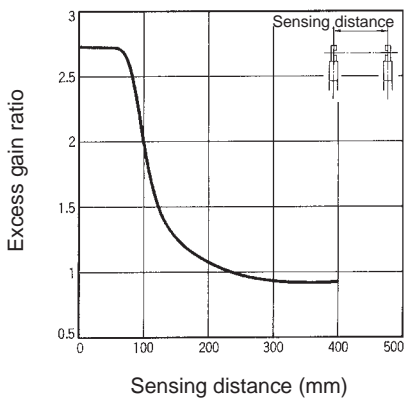

**E32-T17L**

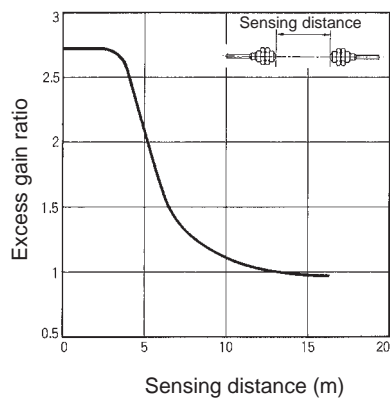

**E32-T16**

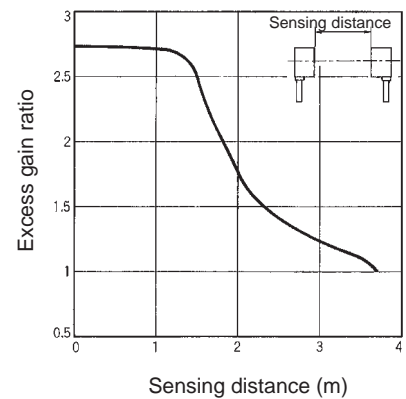

**E32-DC200**

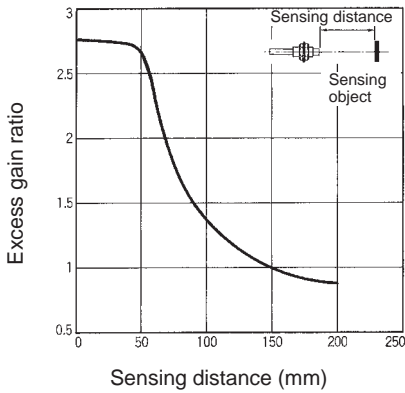

**E32-D11L**

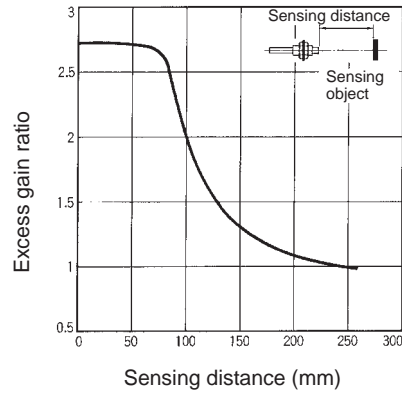

**E32-D21L**

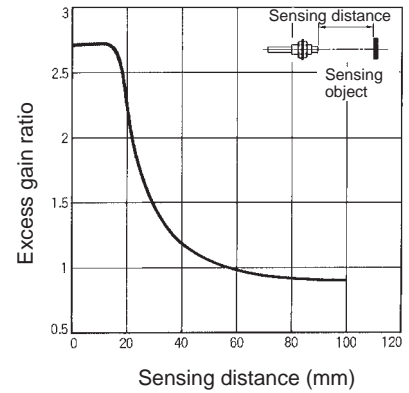

**E3X-H11**

**E32-TC200**

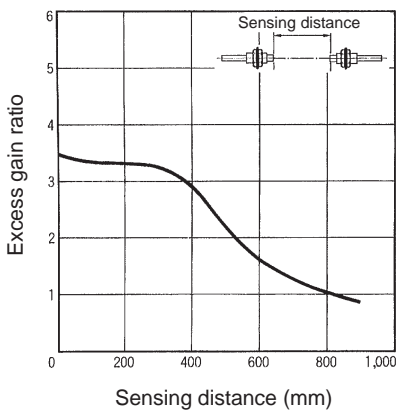

**E32-TC200 + E39-F1**

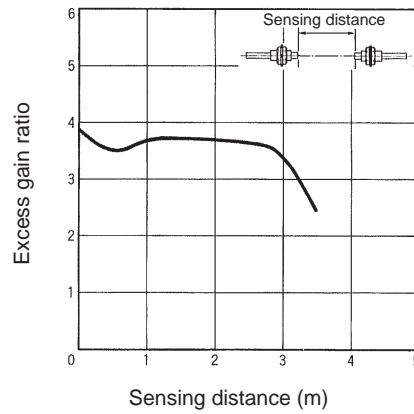

**E32-T11L**

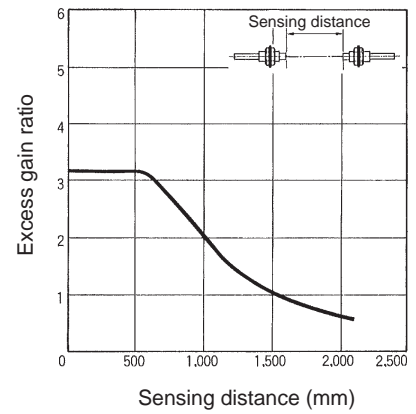

**E32-T11L + E39-F1**

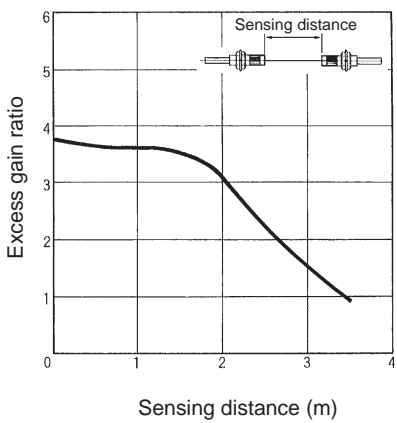

**E32-T11L + E39-F2**

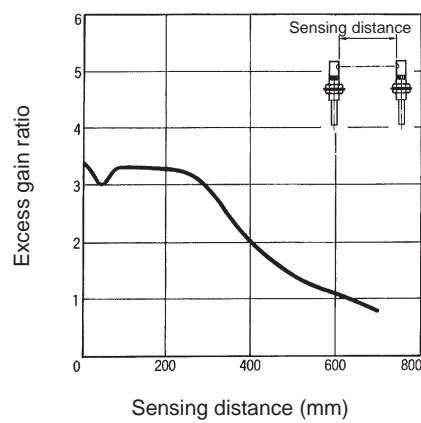

**E32-T11L + E39-F3**

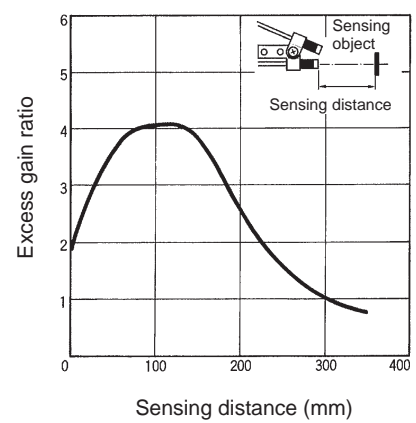

E32-T21L

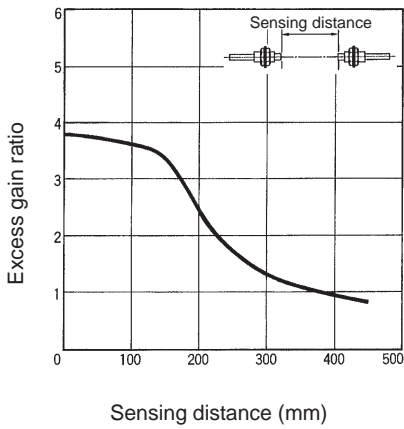

E32-T14L

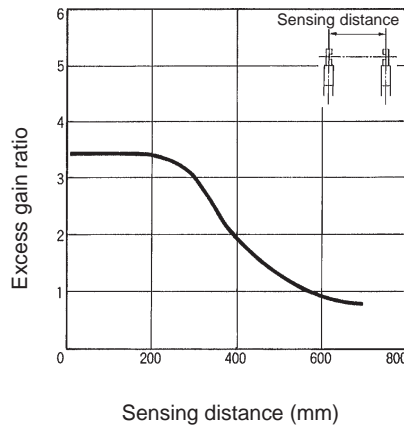

E32-T17L

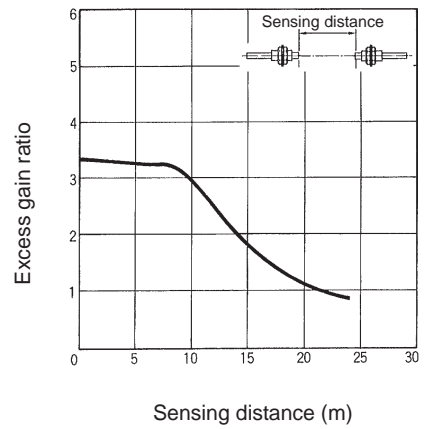

E32-T16

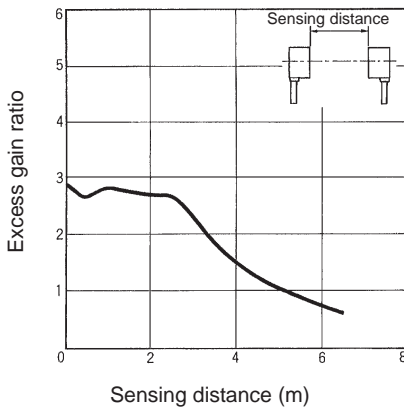

E32-T22S

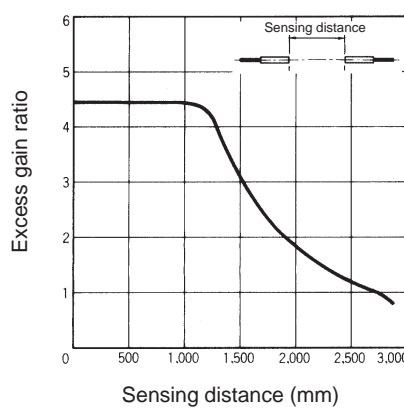

E32-T24S

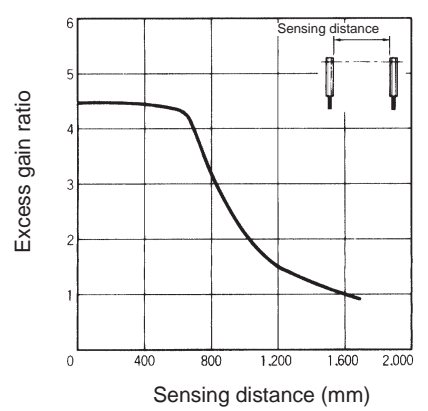

E32-DC200

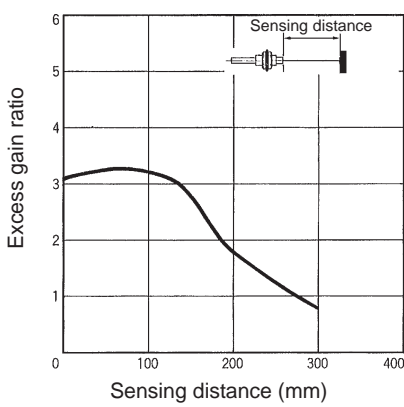

E32-D11L

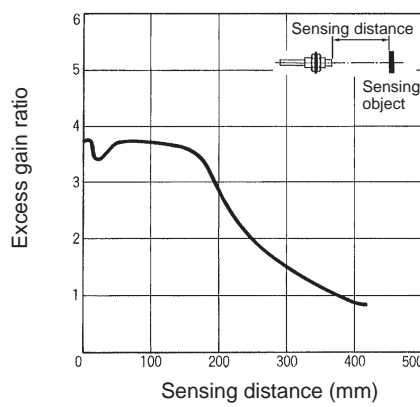

E32-D21L

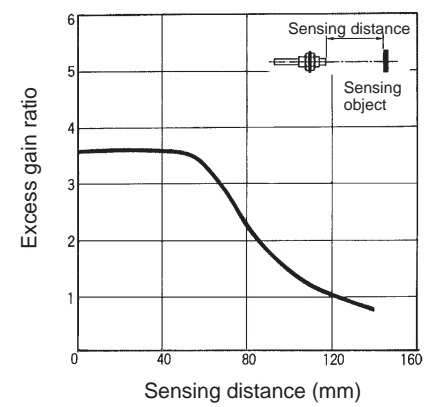

**E32-T84S**

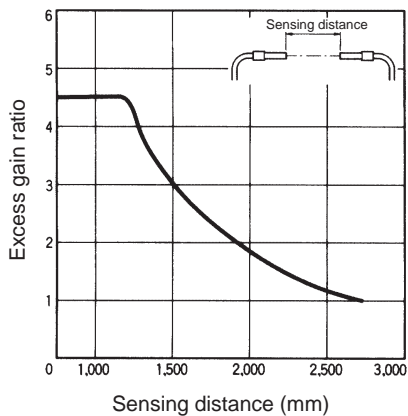

**E3X-A□□/-F□□/-VG□□**

**E32-T11L, E32-T12L**

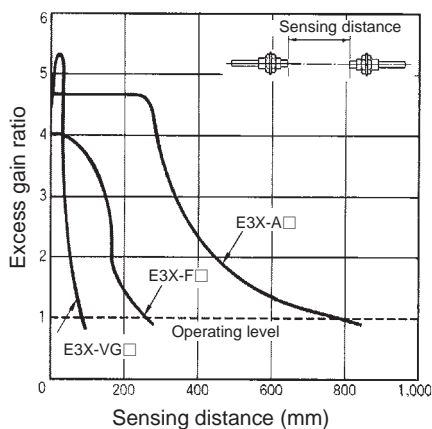

**E32-T11L + E39-F1**

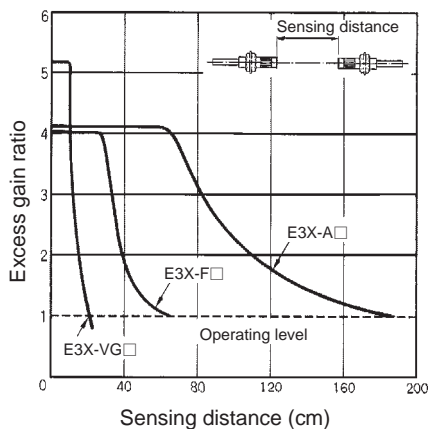

**E32-T11L + E39-F2**

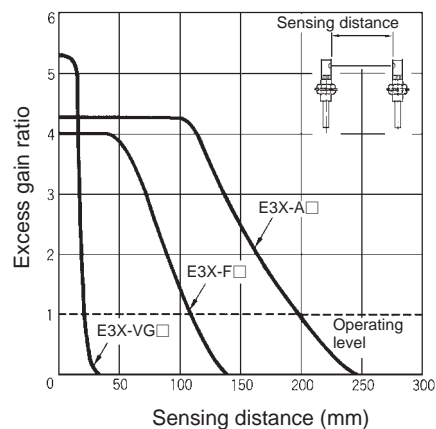

**E32-T11L + E39-F3**

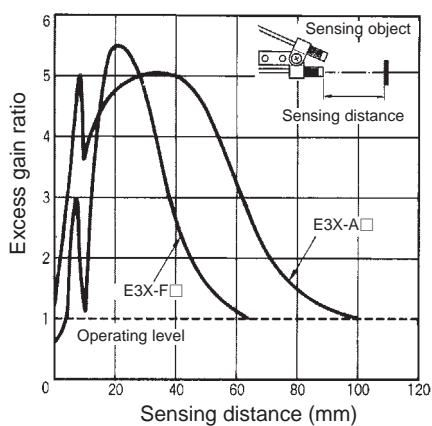

**E32-T21L, E32-T22L**

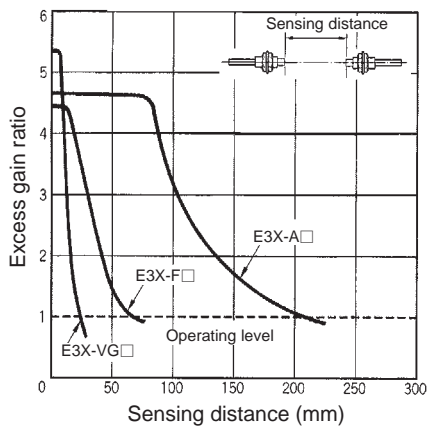

**E32-T14L**

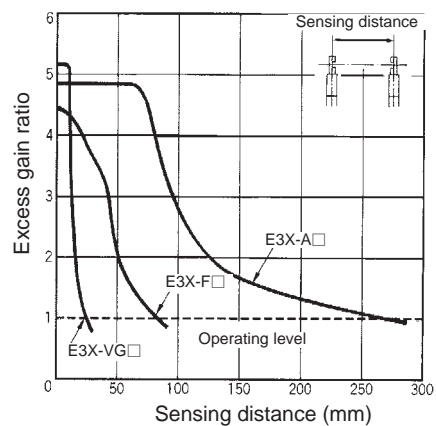

E32-T17L

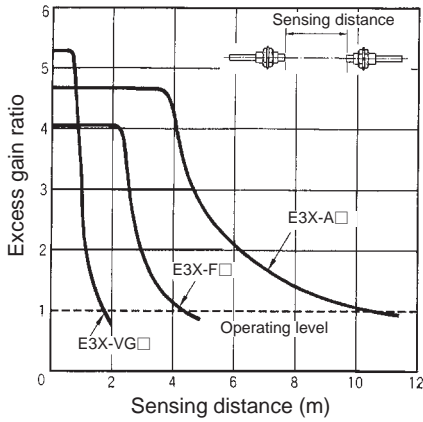

E32-T12F

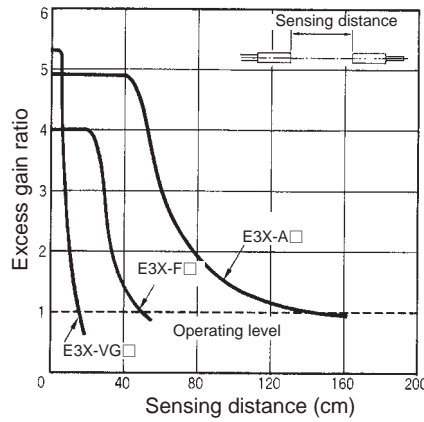

E32-D11L

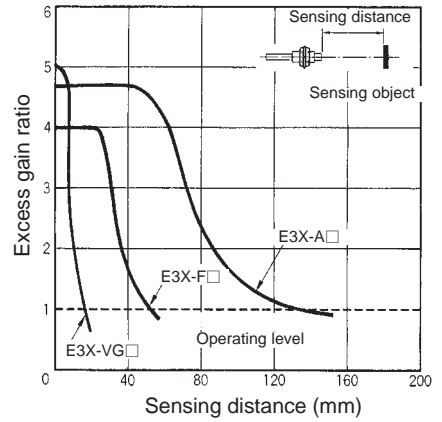

E32-D21L, E32-D22L

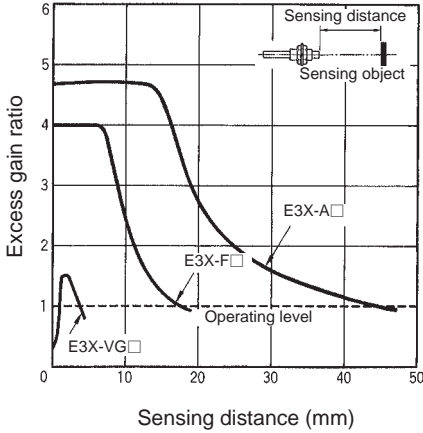

E32-D14L

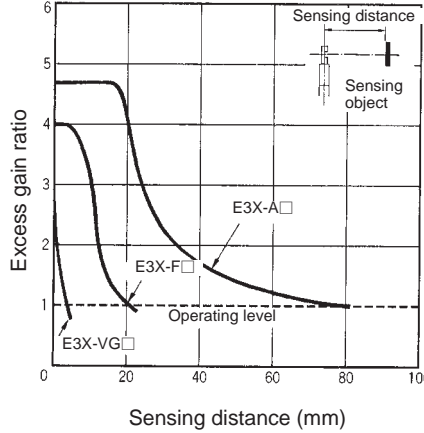

E32-D12F

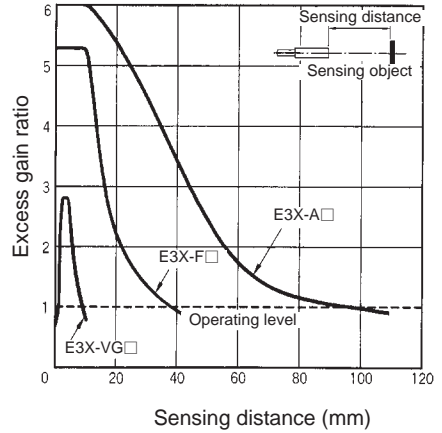

■ Operating Range

E3X-T□□

E32-DC200

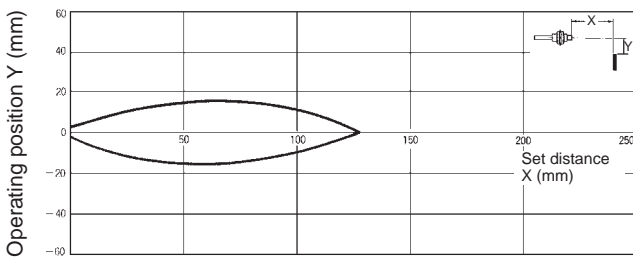

E32-D11L

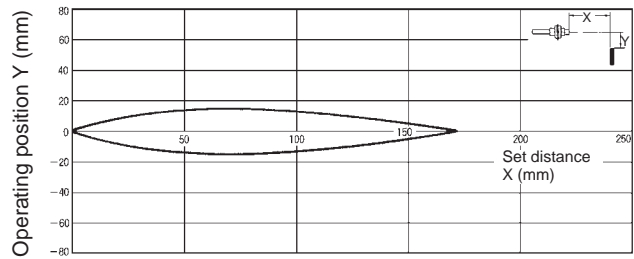

E32-D21L

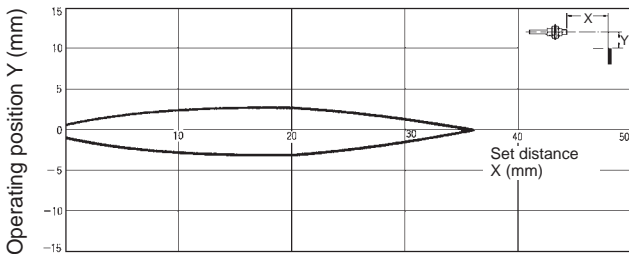

E3X-H11

E32-T11L + E39-F3

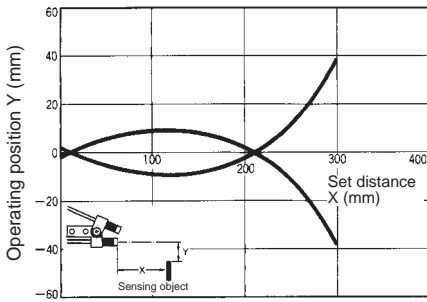

E32-DC200

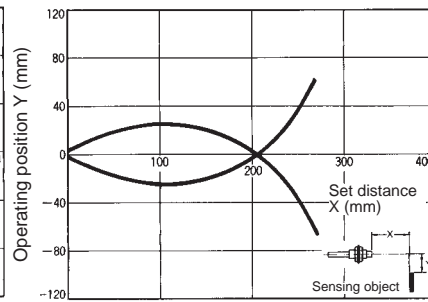

E32-D11L

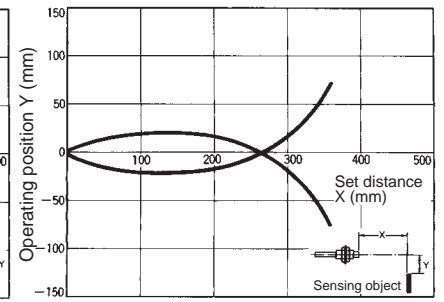

E32-D12

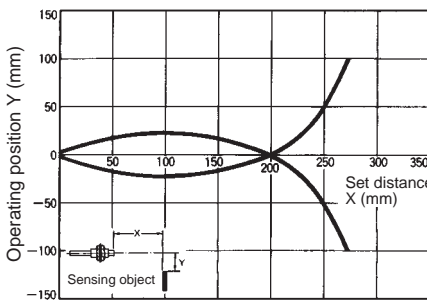

E32-D21L

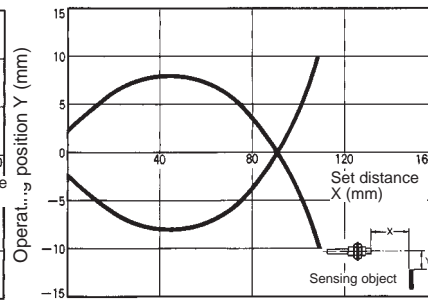

E32-DC200E

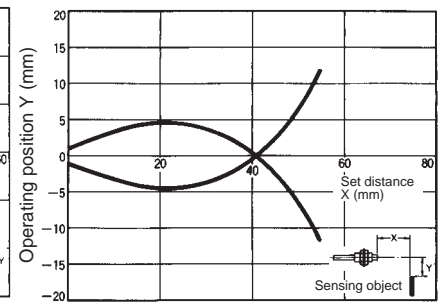

E32-D21

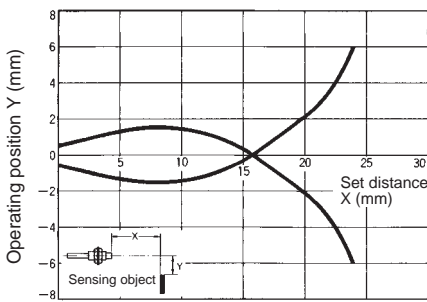

E32-D11

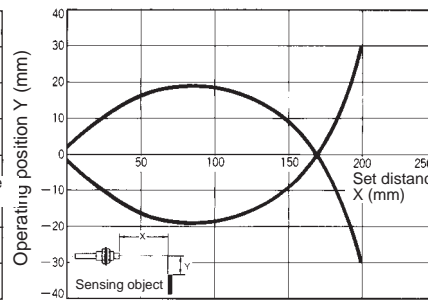

E32-CC200

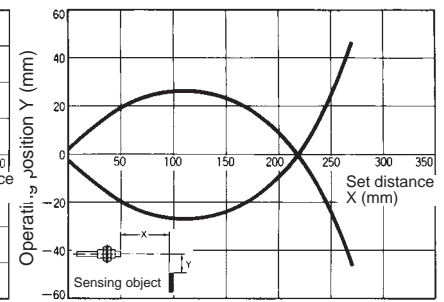

E32-D32

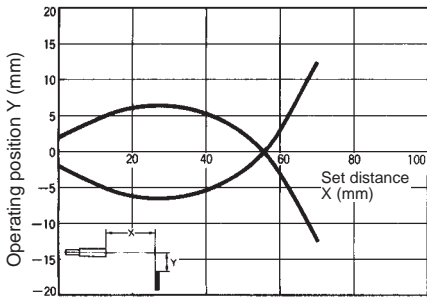

E32-D32L

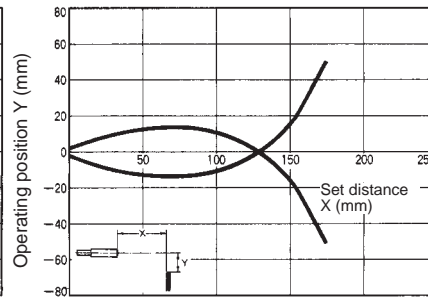

E32-D33

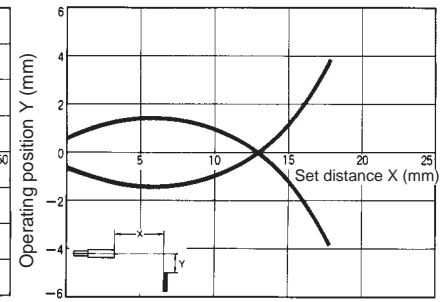

E32-D51

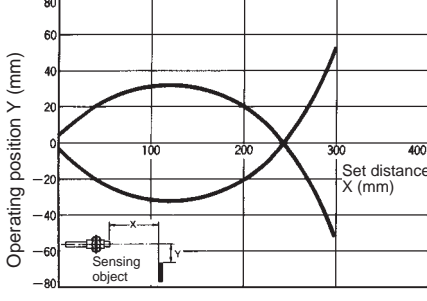

E32-L25L

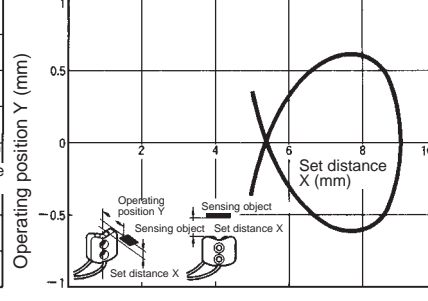

E32-T84S

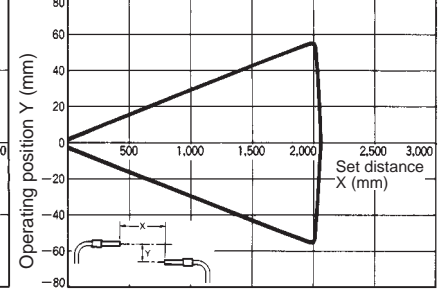

E3X-A□□/-F□□/-VG□□

E32-T11L + E39-F3

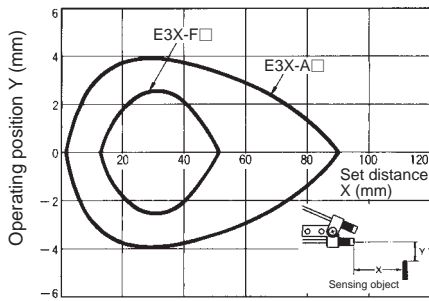

E32-DC200

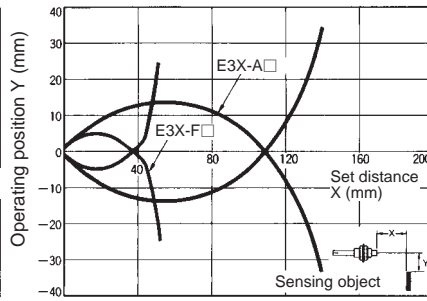

E32-D11L

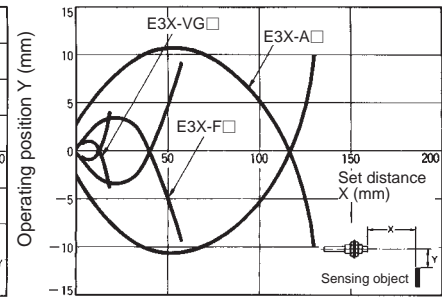

**Note:** With E3X-A: Adjust the angle of E39-F3 so that the sensor can sense an object at a distance of 90 mm. (For E3X-F: 50 mm)

E32-D12

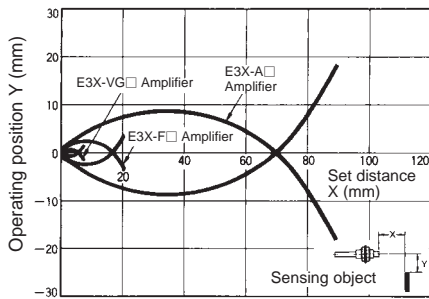

E32-D21L + E32-D22L

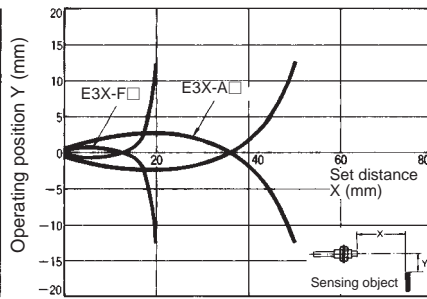

E32-DC200E

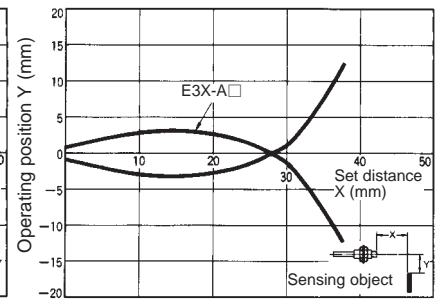

E32-D21

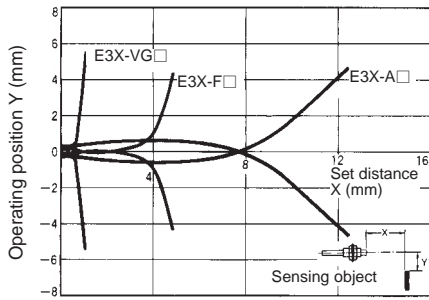

E32-D11

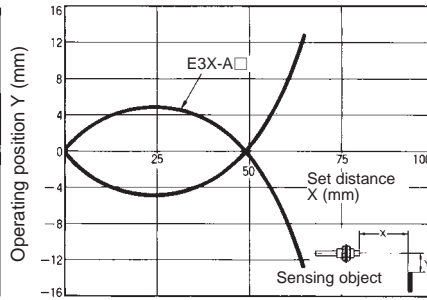

E32-D33

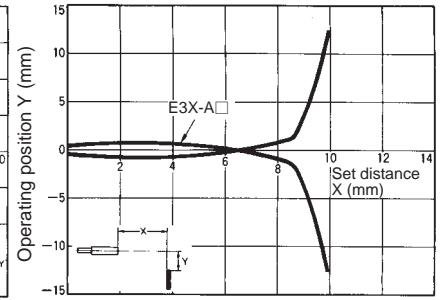

E32-CC200

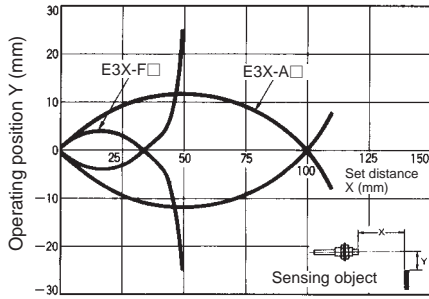

E32-D32L

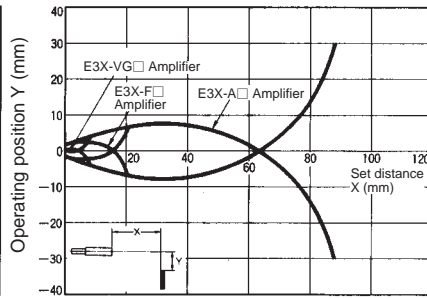

E32-D14L

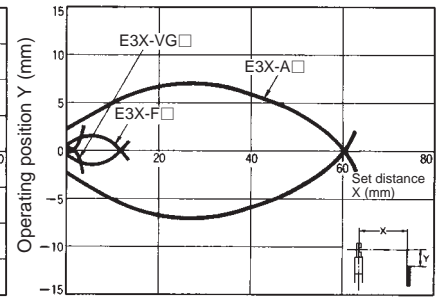



E32-D24

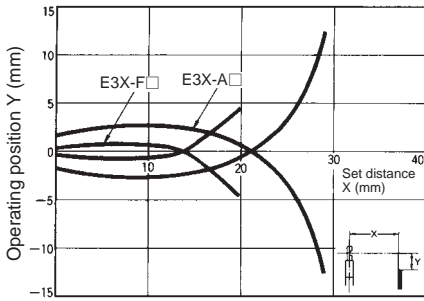

E32-D12F

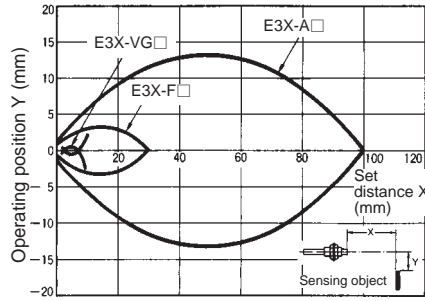

E32-D51

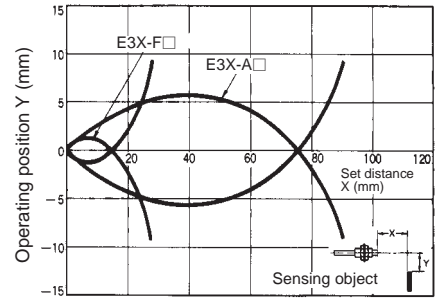

E32-D61

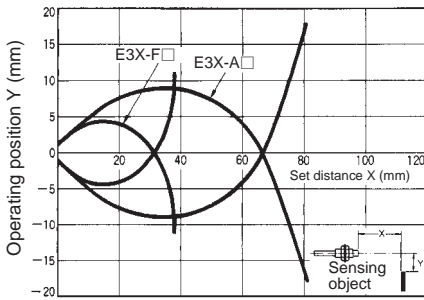

E32-D73

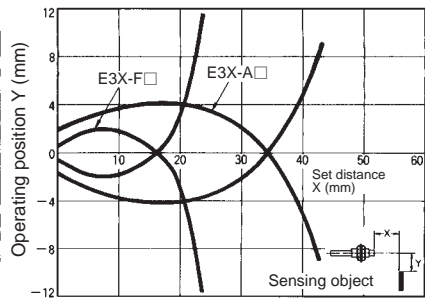

E32-R16

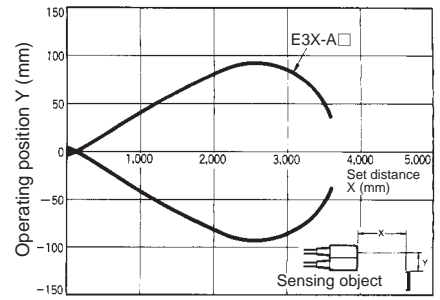

E32-L25L

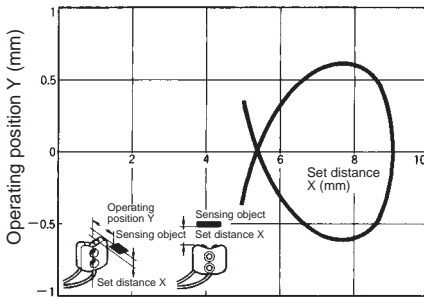

■ Parallel Operating Range (Typical)

E3X-T□□

E32-TC200

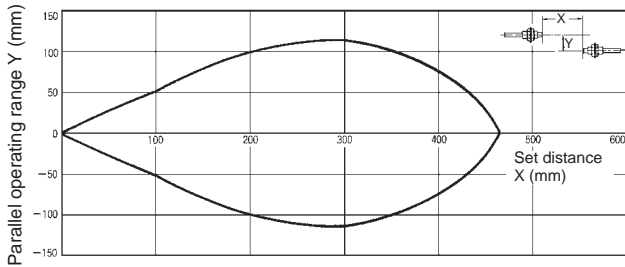

E32-T11L

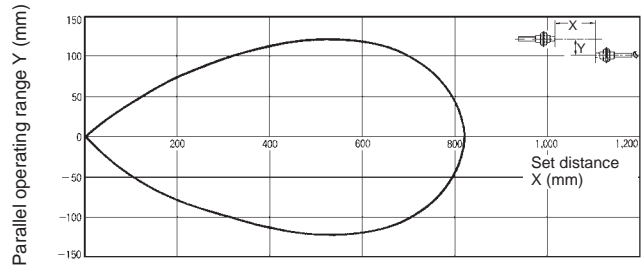

E32-T11L + E39-F1

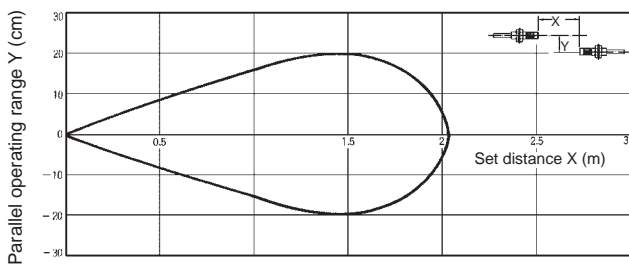

E32-T11L + E39-F2

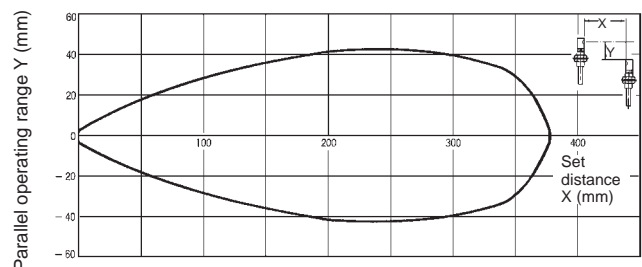

E32-T21L

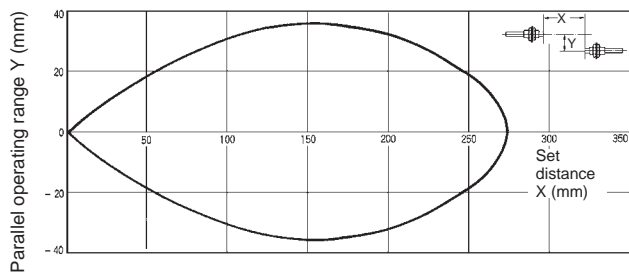

E32-T14L

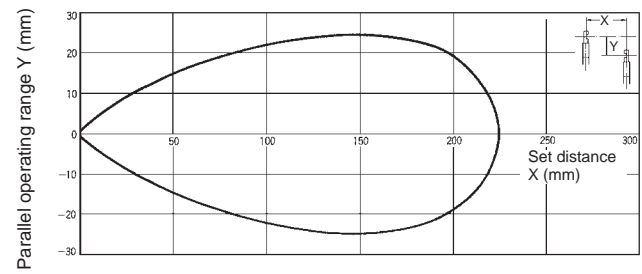

E32-T17L

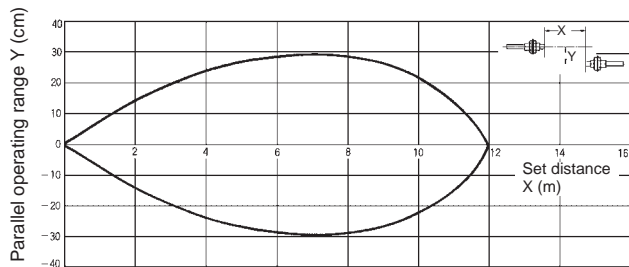

E32-T12F

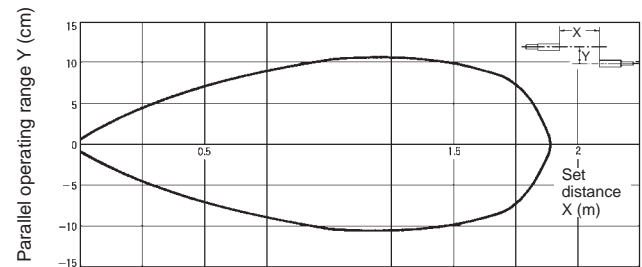

E3X-H11

E32-TC200

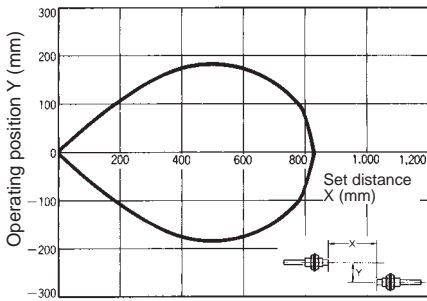

E32-TC200 + E39-F2

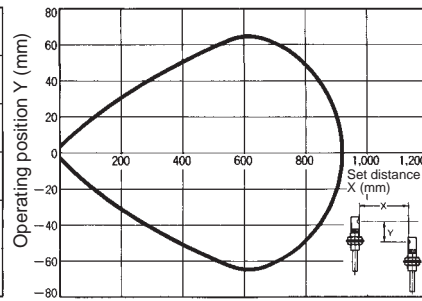

E32-T11L

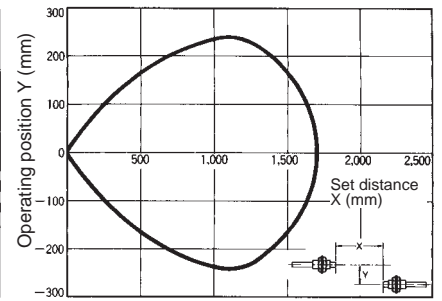

E32-T11L + E39-F1

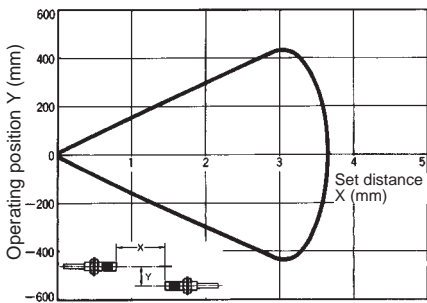

E32-T11L + E39-F2

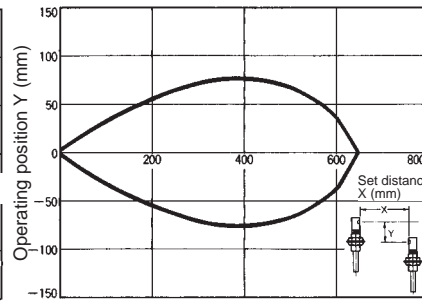

E32-T21L

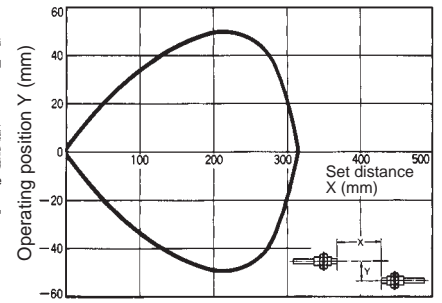

E32-T21L

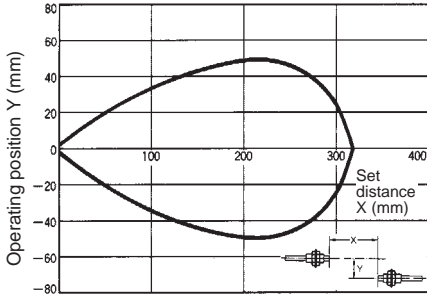

E32-T22

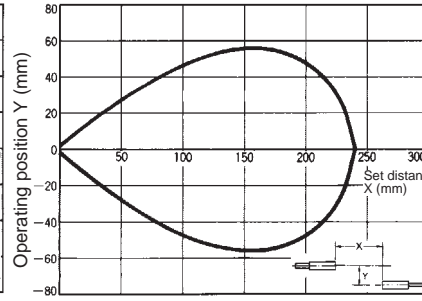

E32-T11

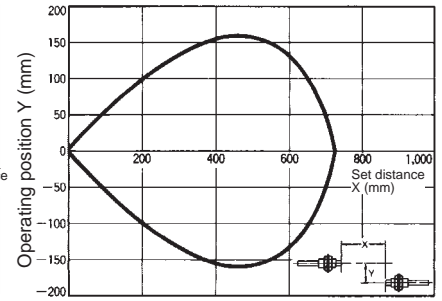

E32-T21

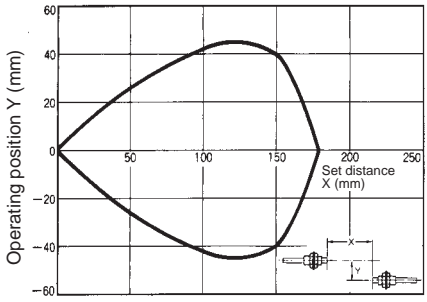

E32-T14L

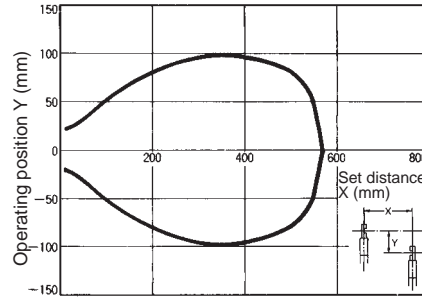

E32-T24

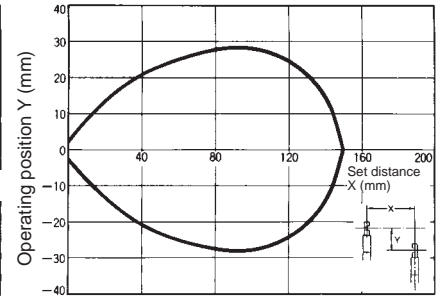

E32-T14

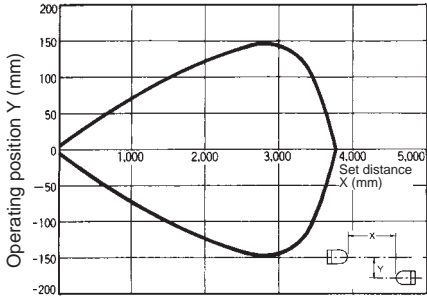

E32-T17L

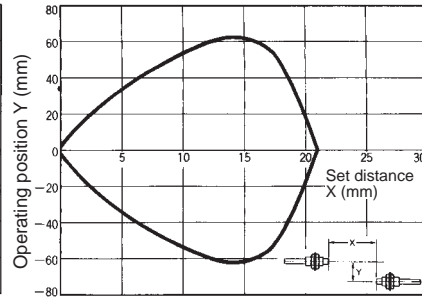

E32-T12F

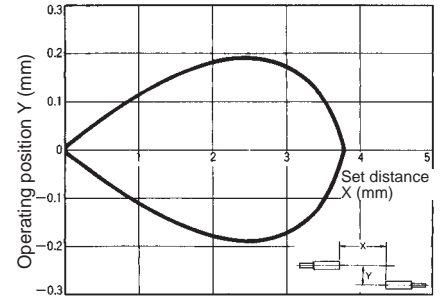

**E32-M21**

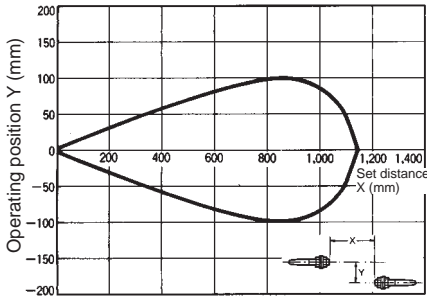

**E32-T51**

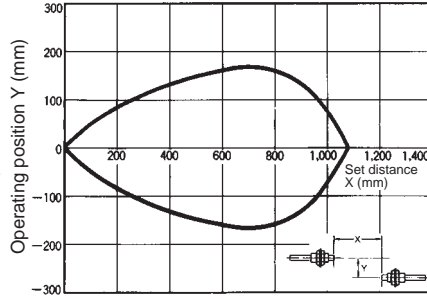

**E32-T61**

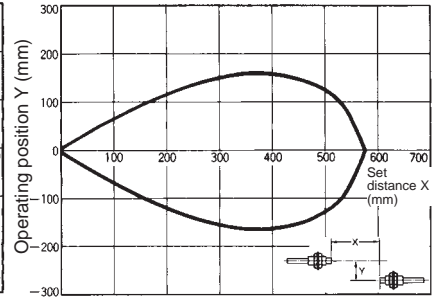

**E32-T22S**

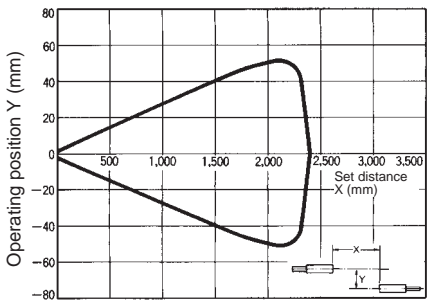

**E32-T24S**

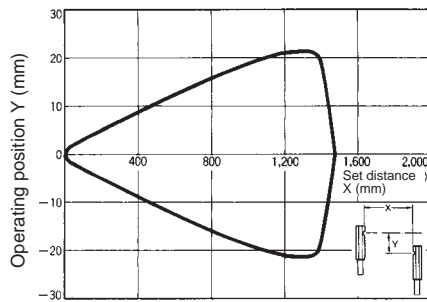

**E3X-A□□/-F□□/-VG□□**

**E32-TC200**

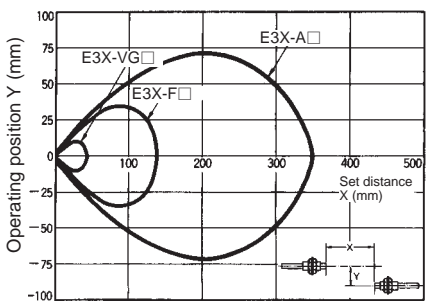

**E32-TC200 + E39-F2**

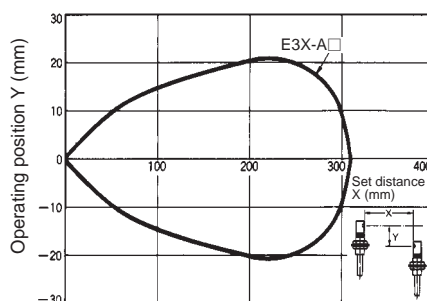

**E32-T11L/-T12L**

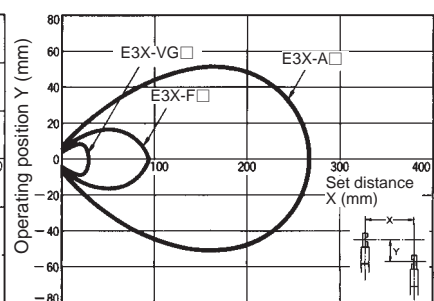

**E32-T11L + E39-F1**

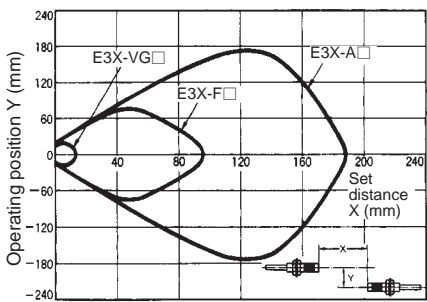

**E32-T11L + E39-F2**

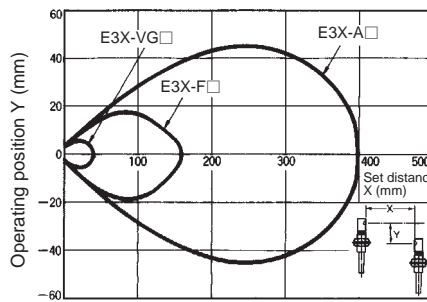

**E32-T21L/-T22L**

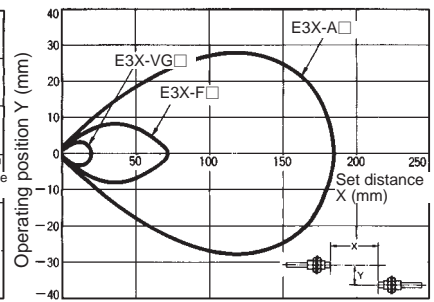

E32-TC200E

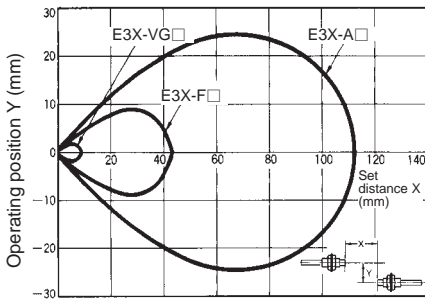

E32-T11

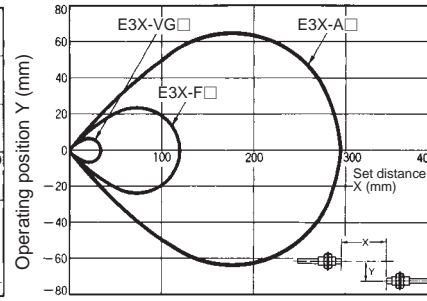

E32-T21

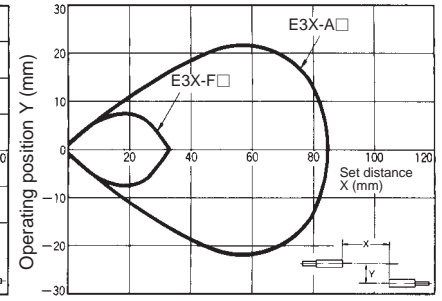

E32-T14L

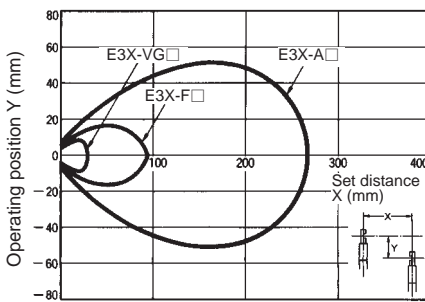

E32-T24

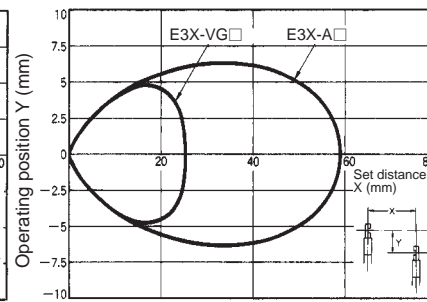

E32-T14

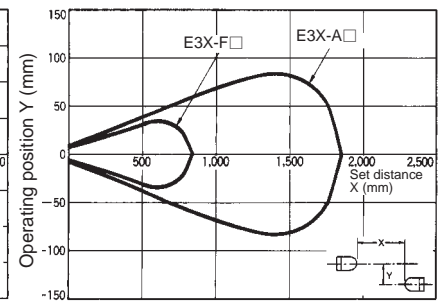

E32-T17L

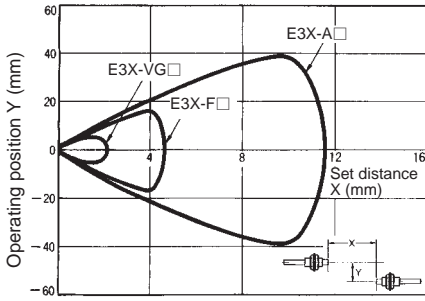

E32-T12F

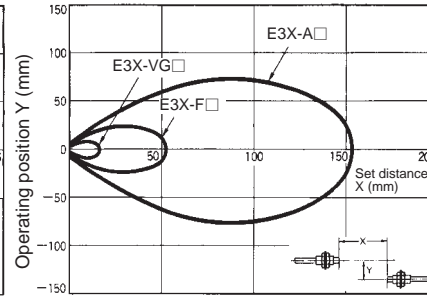

E32-M21

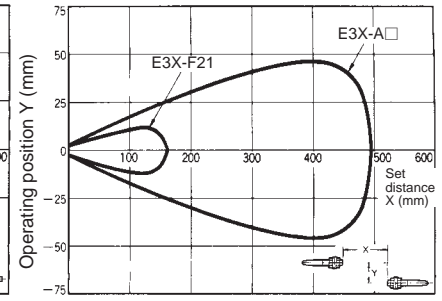

E32-T51

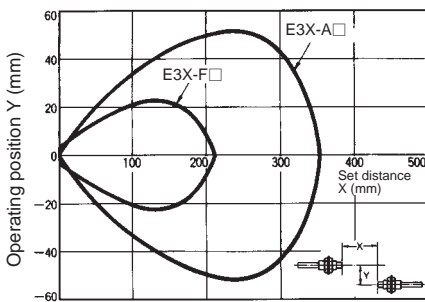

E32-T61

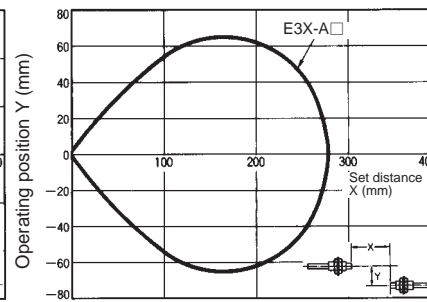

E32-T61 + E39-F1

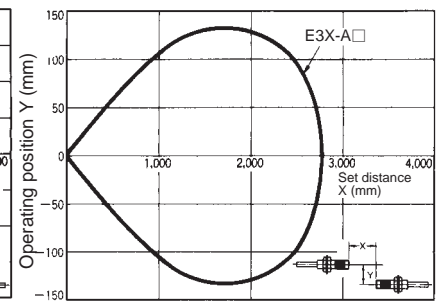

E32-T22S

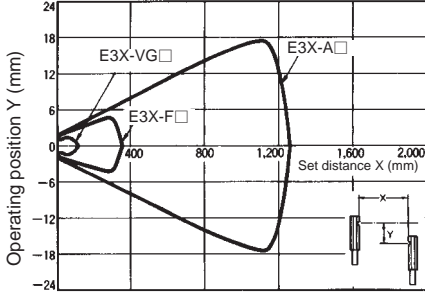

E32-T24S

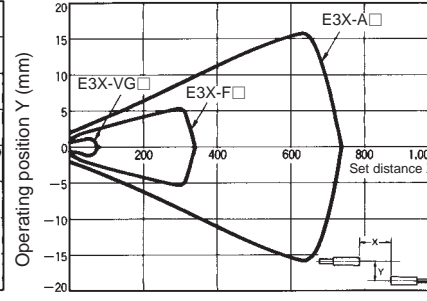

**Number of Turns of Sensitivity Adjuster and Sensing Distance (Typical)**  
**E3X-H/E32-D11L**

Sensing Object: White Paper of 5 x 5 cm

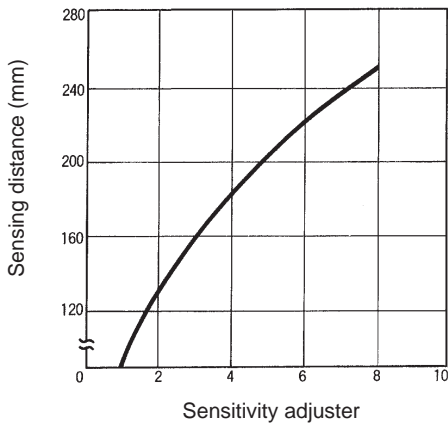

**E3X-A, -F/E32-D11L**

Sensing Object: White Paper of 10 x 10 cm with E3X-A and 5 x 5 cm with E3X-F

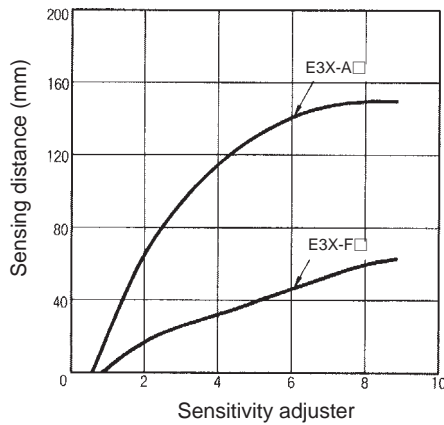

**Color Sensing (Typical)**  
**Green Light Source E3X-VG□ /E32-D11L**

The following graph shows the relationship between colors and the number of turns of the sensitivity adjuster when the E32-D11L is in operation with the sensing distance adjusted to 5 mm.

Munsell chroma (MC)

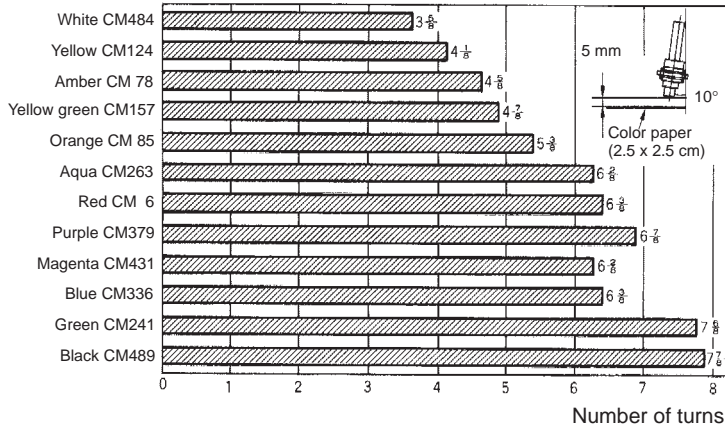

# Nomenclature

## E3X-T□□

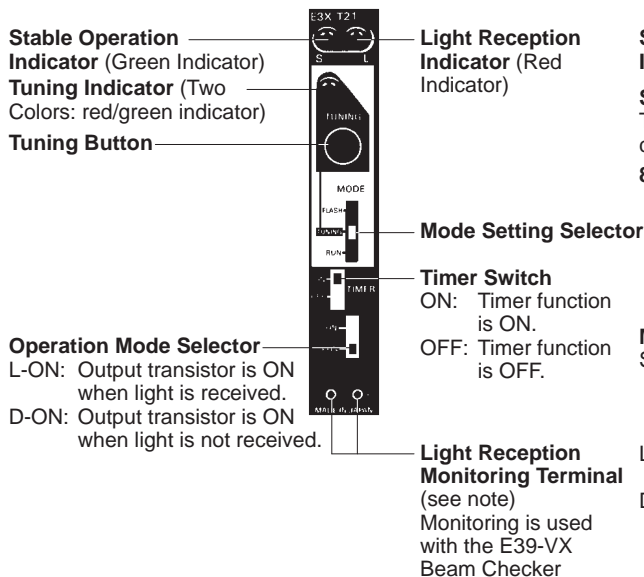

## E3X-H11

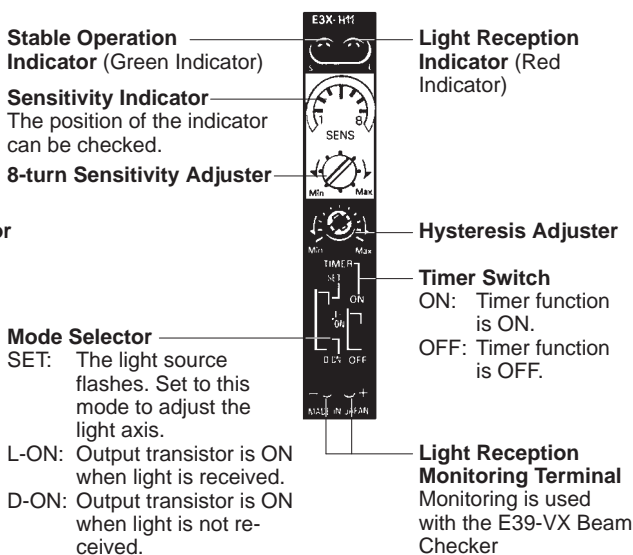

**Note:** The light reception monitoring terminal is not available with the E3X-T11.

## E3X-A11/A41 E3X-VG11

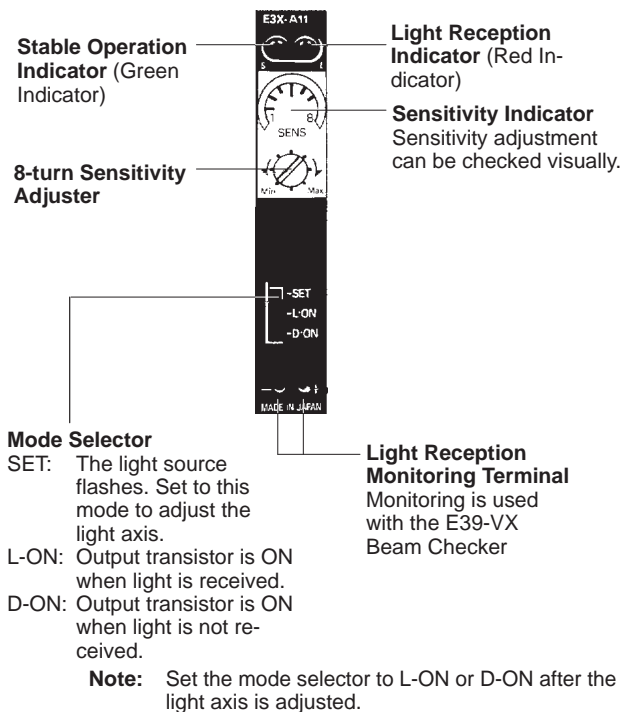

## E3X-A21/A51 E3X-F21/F51 E3X-VG21

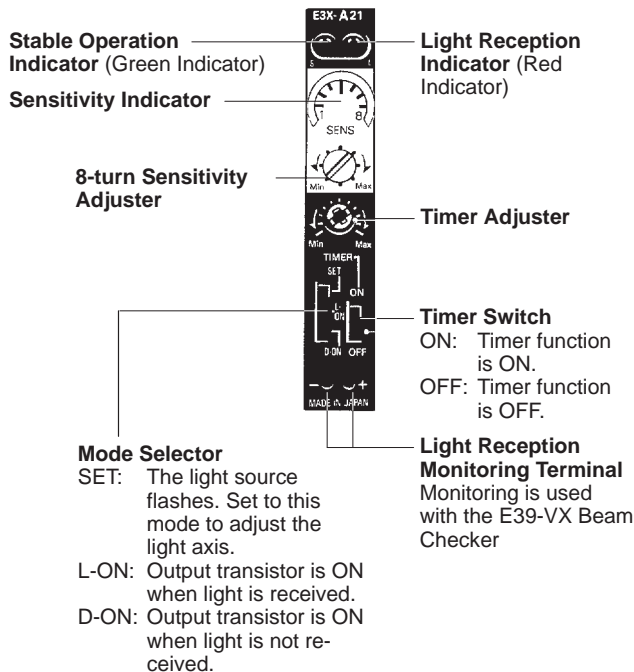

# Operation

















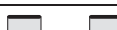











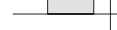



## ■ Output Circuits

Type	Model	Mode switch	Output transistor	Output circuit
NPN	E3X-T21	Light ON	ON when light is received.	
		Dark ON	ON when light is not received.	
E3X-T11 E3x-H11 E3X-A11 E3X-VG11		Light ON	ON when light is received.	
		Dark ON	ON when light is not received.	
E3X-A21 E3X-VG21 E3X-F21		Light ON	ON when light is received.	
		Dark ON	ON when light is not received.	
PNP	E3X-A41	Light ON	ON when light is received.	
		Dark ON	ON when light is not received.	
E3X-A51 E3X-F51		Light ON	ON when light is received.	
		Dark ON	ON when light is not received.	



■ Timing Charts

Type	Model	Mode switch	Output transistor	Timing chart
NPN	E3X-T21	Light ON	ON when light is received.	Light received Light not received Light indicator (Red) ON OFF Output transistor ON OFF Load (relay) Operate Release (Between brown and black)
		Dark ON	ON when light is not received.	Light received Light not received Light indicator (Red) ON OFF Output transistor ON OFF Load (relay) Operate Release (Between brown and black)
	E3X-T11 E3X-H11 E3X-A11 E3X-VG11	Light ON	ON when light is received.	Light received Light not received Light indicator (Red) ON OFF Output transistor ON OFF Load (relay) Operate Release (Between brown and black)
		Dark ON	ON when light is not received.	Light received Light not received Light indicator (Red) ON OFF Output transistor ON OFF Load (relay) Operate Release (Between brown and black)
	E3X-A21 E3X-VG21 E3X-F21	Light ON	ON when light is received.	Light received Light not received Light indicator (Red) ON OFF Output transistor ON OFF Load (relay) Operate Release (Between brown and black)
		Dark ON	ON when light is not received.	Light received Light not received Light indicator (Red) ON OFF Output transistor ON OFF Load (relay) Operate Release (Between brown and black)

Type	Model	Mode switch	Output transistor	Timing chart
PNP	E3X-A41	Light ON	ON when light is received.	Light received:  Light not received:  Light indicator (Red) ON:  Light indicator (Red) OFF:  Output transistor ON:  Output transistor OFF:  Load (relay) Operate:  Load (relay) Release:  (Between blue and black)
		Dark ON	ON when light is not received.	Light received:  Light not received:  Light indicator (Red) ON:  Light indicator (Red) OFF:  Output transistor ON:  Output transistor OFF:  Load (relay) Operate:  Load (relay) Release:  (Between blue and black)
	E3X-A51 E3X-F51	Light ON	ON when light is received.	Light received:  Light not received:  Light indicator (Red) ON:  Light indicator (Red) OFF:  Output transistor ON:  Output transistor OFF:  Load (relay) Operate:  Load (relay) Release:  (Between blue and black)
		Dark ON	ON when light is not received.	Light received:  Light not received:  Light indicator (Red) ON:  Light indicator (Red) OFF:  Output transistor ON:  Output transistor OFF:  Load (relay) Operate:  Load (relay) Release:  (Between blue and black)

## ■ Sensitivity Adjustment

### E3X-T□□

1. Locate the sensor head in the sensing range of the E3X.
2. Set the mode selector to TUNING.
3. Locate the object at the sensing position and press the tuning button.

**Through-beam Model**

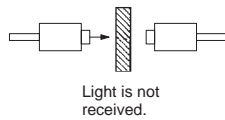

**Reflective Model**

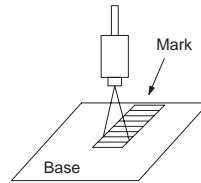

**Reflective Model**

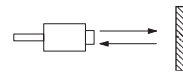

The tuning indicator (red) is lit.  
The built-in buzzer beeps once.

4. Move the object and press the tuning button.

**Through-beam Model**

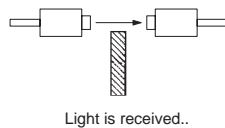

**Reflective Model**

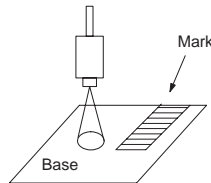

**Reflective Model**

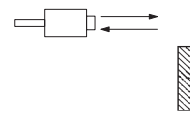

If tuning is OK: The tuning indicator turns green.  
The built-in buzzer beeps once.  
If tuning is NG: The tuning indicator (red) is still lit.  
The built-in buzzer beeps 3 times.

Change the position of the object and the sensing distance that have been set and repeat from the beginning.

5. Set the mode setting selector to RUN to complete the sensitivity setting on the E3X.  
The tuning indicator (green) is OFF.
6. Select the logical output required with the operation mode selector.











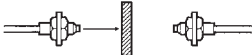



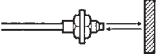

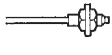
### Maximum Sensitivity Setting

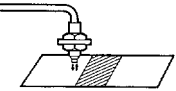
1. Set the mode setting selector to TUNING.
2. Press the tuning button, at which time the object may or may not be located at the sensing position.  
The tuning indicator (red) is lit.  
The built-in buzzer beeps once.
3. Set the mode setting selector to RUN to complete the maximum sensitivity setting on the E3X. It will take approximately three seconds for the stable operation indicator or light reception indicator to be lit. After the maximum sensitivity setting is completed, the tuning indicator will turn green and then it will be automatically turned OFF in approximately three seconds. The maximum sensitivity of the E3X can be automatically set regardless of the set distance or light reception.

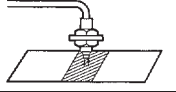
**Note:** The sensitivity of the E3X-T11 and E3X-T21 are set to maximum before shipping.

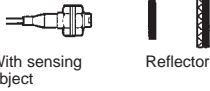
E3X-H11/-A□□/-F□□/-VG□□

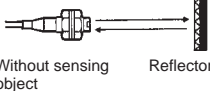
Using a sensing object, adjust Sensitivity Adjustor so that the indicators operate as described in the following table:

Sensing method		Sensing	Light	Indicators
Through-beam		 With sensing object	Interrupted	 Green: Light ON Red: Light OFF
		 Without sensing object	Incident	 Green: Light ON Red: Light ON
Reflective	Sensing	 With sensing object	Incident	 Green: Light ON Red: Light ON
		 Without sensing object	Interrupted	 Green: Light ON Red: Light OFF
	Sensing of the difference in color or shade	 Color that has a high reflection ratio	Incident	 Green: Light ON Red: Light ON
		 Color that has a low reflection ratio	Interrupted	 Green: Light ON Red: Light OFF
Retroreflective		 With sensing object Reflector	Interrupted	 Green: Light ON Red: Light OFF
		 Without sensing object Reflector	Incident	 Green: Light ON Red: Light ON

- Note:**
1. If the indicators operate as described in the table, the E3X can operate in stable condition within the rated temperature range.
  2. Even when the green indicator is OFF, the E3X will operate stably if the operating temperature change since the initial settings is within +10°C.

## ■ Light Axis Adjustment with Flashing Function

### E3X-T□□

This function enables the user to adjust with ease the light axis of the through-beam fiber with the light source flashing. All E3X models have this function.

1. Set the mode setting selector to FLASH.

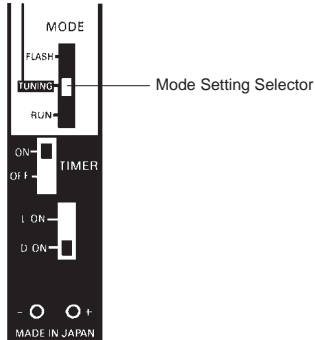

2. If the axis of the light emission fiber head and that of the light reception fiber head do not agree with each other and the amount of light reception becomes 90% of the peak value or less, the flashing function of the E3X will work. The E3X retains the peak value when the mode setting selector is set to FLASH and the axes of the fiber heads are adjusted to agree with each other.

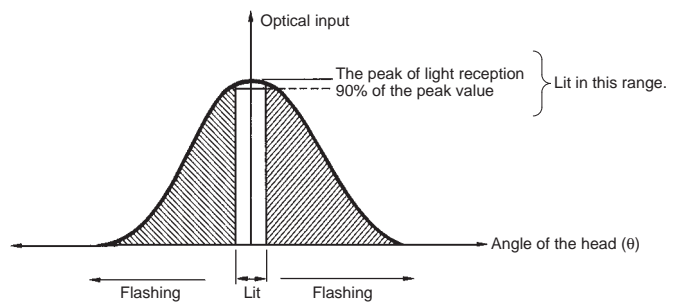
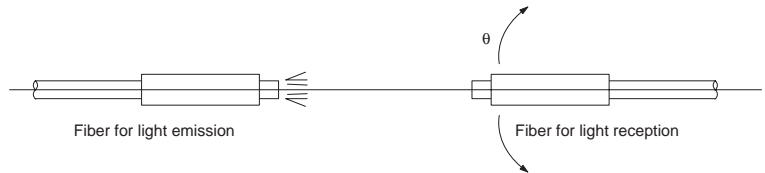

### E3X-A□□/-F□□/-VG□□

1. Set the mode selector to SET.

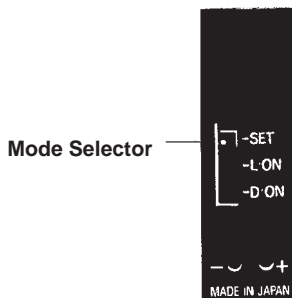

2. Adjust the light axis by moving the fiber with the light flashing.

#### Improper Light Axis

#### Proper Light Axis

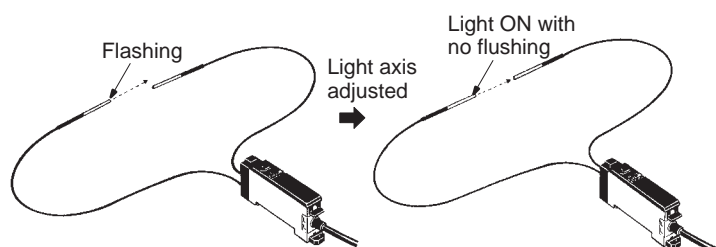

3. Set the mode selector to L-ON or D-ON after the light axis is adjusted.

**Self-diagnostic Function**

With this function, the E3X checks changes in environmental conditions (especially a change in the ambient temperature) and self-diagnoses the resistance against the changes. The result is shown by the indicators or an output signal.

**Stable Operation Indicator (Green Indicator)**

**Light Reception Indicator (Red Indicator)**

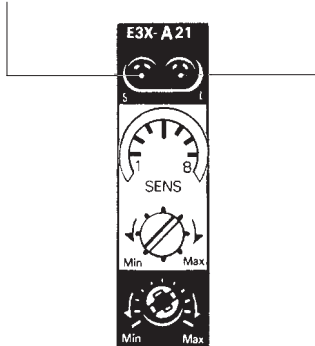

**Displays**

- **Stable Operation Indicator:** Changes in environmental conditions (changes in the ambient temperature, the operating voltage, or the volume of dust) are checked and the resistance against them are self-diagnosed. The result is shown via the indicator.
- **Light Reception Indicator:** The amount of light received is indicated by this indicator.

**Output**

- The resistance against changes in environmental conditions is indicated by the indicator and the result is output.

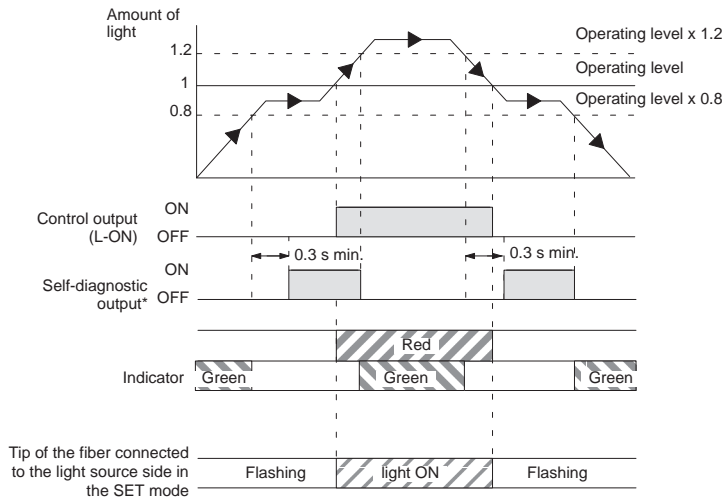

\*If the self-diagnostic output is ON when the sensing object is moving at low speed, use the E3X with an ON-delay timer circuit.

**Remote Tuning/Remote Bank Function (E3X-T21)**

**Remote Tuning Function**

Basically, the method of remote tuning is same as that of sensitivity adjustment. When the remote tuning function of the E3X is used, the E3X is tuned with the remote tuning input signal instead of the tuning button which has to be pressed.

1. Set the mode selector to RUN.
2. The following signal conditions must be given as remote tuning input conditions.

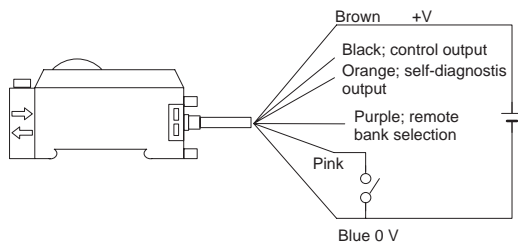

If no remote tuning is done, cut off the purple wire at its source or connect the pink wire to the positive terminal of the power supply.

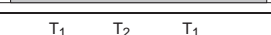
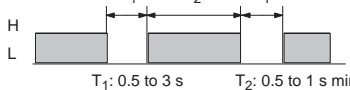
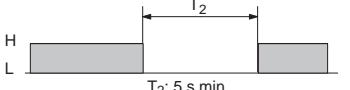
Power supply		ON  OFF 
Remote tuning input	Sensitivity setting	 $T_1: 0.5 \text{ to } 3 \text{ s}$ $T_2: 0.5 \text{ to } 1 \text{ s min.}$
	Maximum sensitivity	 $T_2: 5 \text{ s min.}$

**Remote Bank Function**

The remote bank input signal allows the setting of two kinds of sensitivity adjustment values.

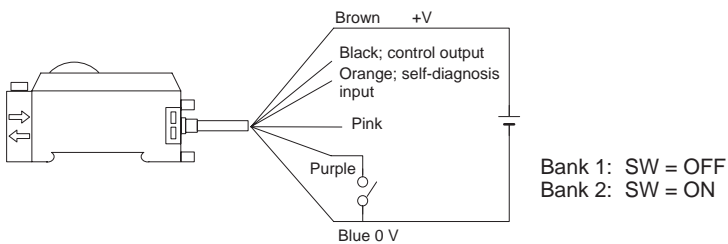

To set two kinds of sensitivity adjustment values, the purple and blue wires must be connected with each other and select bank 2 to tune the E3X.

**Variable Hysteresis Function (E3X-H11)**

**Sensing of Plate Level Differences**

Refer to the following when using the hysteresis adjuster.

(If sensing is impossible with the hysteresis value set to maximum)

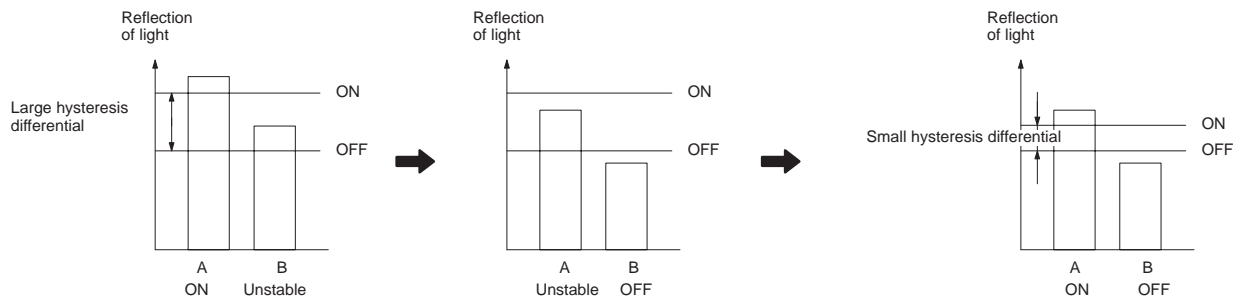

Sensing operation is not stable because zone B is within the hysteresis differential range.

Reduce the sensitivity of the E3X with the sensitivity adjuster and turn off zone B.

Reduce the hysteresis value with the hysteresis adjuster so that zone A will be ON.

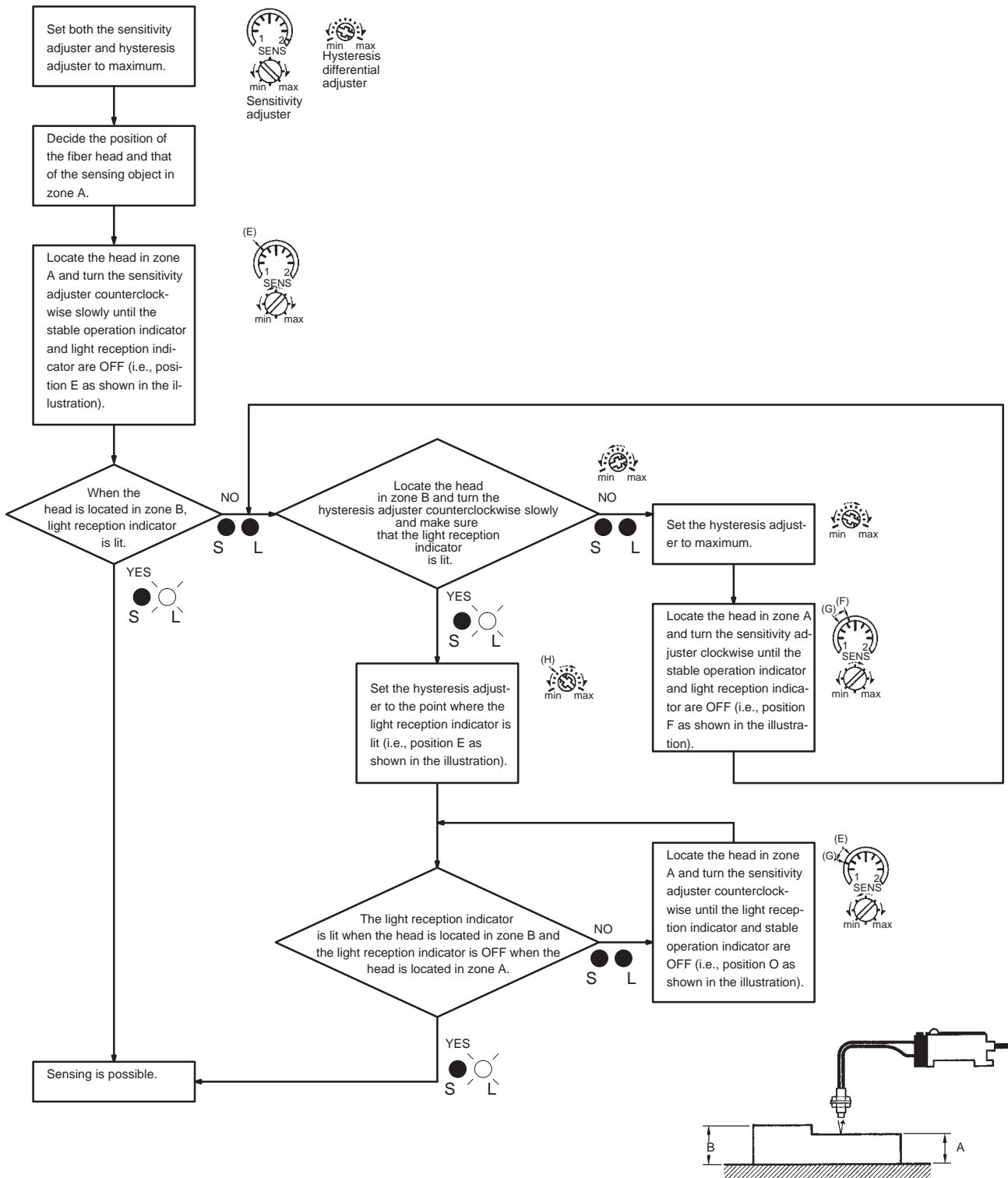



**External Diagnostic Input Function**

With this function, light projection can be stopped when desired. The operation of the sensor can be checked with this function before the E3X is placed into actual operation.

**E3X-A□□**

Light is emitted from the projection fiber head when the self-diagnostic input is ON. The sensor, however, will not operate.

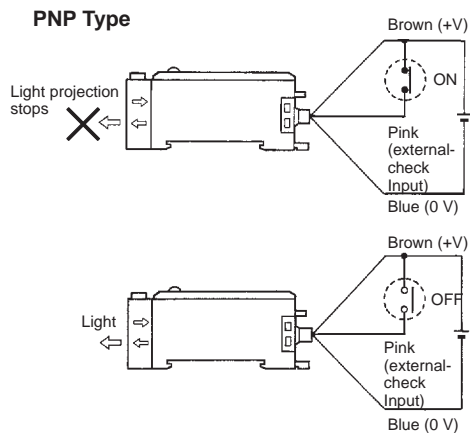
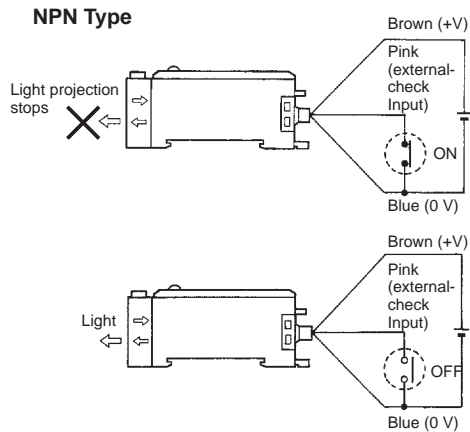

**E3X-F□□/-VG□□**

No light is emitted from the projection fiber head when self-diagnostic input is ON.

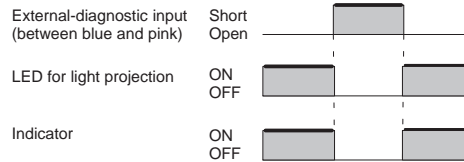

By short-circuiting the pink and blue cords, light projection can be stopped (with a short-circuit current of 0.2 mA max.).

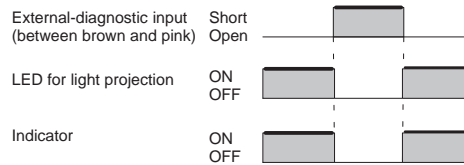

By short-circuiting the brown and pink cords, light projection can be stopped (with a short-circuit current of 0.2 mA max.).

**Special Fiber Units**

The following special accessories are available (order separately). Contact your OMRON representative for the details.

**Fiber Units with Special Length of Stainless Steel Tube**

Fiber with different lengths of stainless steel tubes are available.

**Applicable Models**

- E32-TC200F (tube with 0.9 dia.)
- E32-TC200B/DC200F (tube with 1.2 dia.)
- E32-DC200B (tube with 2.5 dia.)

**Appearance**



The length can be ordered in increments of 10 mm between 10 mm min. and 120 mm max.

Tolerance: +1.0 mm if L is 40 mm or less. and +2.0 if L is more than 40 mm. (Note that standard Fiber Units have a 90-mm or 40-mm long stainless steel tube.)

### Fiber Units with 90° Bend in Stainless Steel Tube

#### Applicable Models

E32-TC200B/TC200F/DC200F

#### Appearance

##### Stainless Steel Tube with a 90° Bend at the Tip

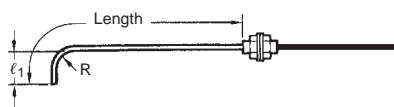

Bending radius	$l_1 (+1)$	
R 5.0	10.0 mm	15.0 mm
R 7.5	12.5 mm	17.5 mm
R 10.0	15.0 mm	20.0 mm
R 12.5	17.5 mm	22.5 mm

The length overall is 120 mm max.

**Note:** If larger  $l_1$  is required, use the E39-F11 Sleeve Bender.

##### Sensing Distance for Tubes with 90° Bends

Model	Amplifier	Bending radius				
		Standard	R5.0	R7.5	R10.0	R12.5
E32-TC200B	E3X-T□□	270 mm	170 mm	220 mm	240 mm	270 mm
	E3X-H11	400 mm	260 mm	330 mm	360 mm	400 mm
	E3X-A□□	180 mm	110 mm	140 mm	160 mm	180 mm
E32-TC200F	E3X-T□□	65 mm	30 mm	65 mm	65 mm	65 mm
	E3X-H11	100 mm	55 mm	100 mm	100 mm	100 mm
	E3X-A□□	50 mm	30 mm	50 mm	50 mm	50 mm
E32-DC200F	E3X-T□□	20 mm	15 mm	20 mm	20 mm	20 mm
	E3X-H11	36 mm	30 mm	36 mm	36 mm	36 mm
	E3X-A□□	18 mm	10 mm	18 mm	18 mm	18 mm

### Stainless Steel Tube with a 90° Bend at the Base

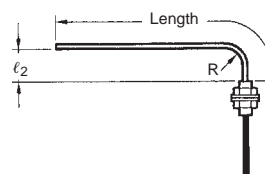

Bending radius	$l_2 (+1)$	
R 5.0	5.0 mm	10.0 mm
R 7.5	7.5 mm	17.5 mm
R 10.0	10.0 mm	20.0 mm
R 12.5	12.5 mm	22.5 mm

The length overall is 120 mm max.

**Note:** If larger  $l_2$  is required, use the E39-F11 Sleeve Bender.

### Fiber Unit with Longer Fiber

#### Applicable Models

E32-TC200/-DC200  
E32-TC200B/-DC200B  
E32-TC200E/-DC200E  
E32-TC200F/-DC200F  
E32-TC200A

#### Appearance



The length can be ordered in increments of 1 m between 6 m min. and 20 m max.. (2-m and 5-m fiber length types are standard for E32-TC200, E32-DC200.)

### Fiber Length vs. Sensing Distance

#### Through-beam Fiber Unit

(Based on the sensing distance using a fiber length of 2 m as 100%)

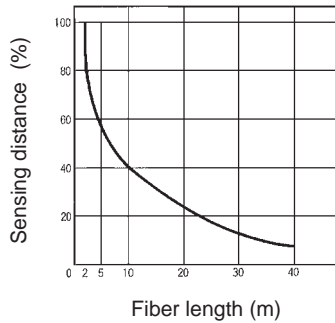

#### Reflective Fiber Unit

(Based on the sensing distance using a fiber length of 2 m as 100%)

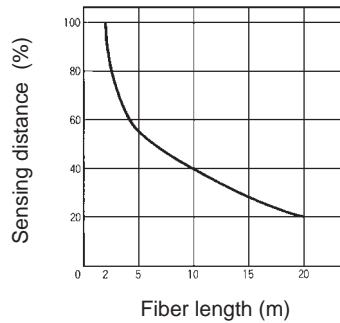

#### E3X-A□□, E32-TC200 (Typical)

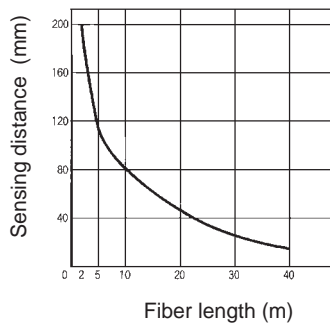

#### E3X-A□□, E32-DC200 (Typical)

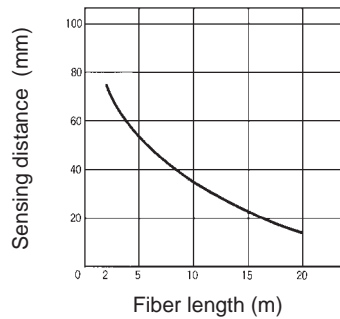

# Dimensions

## ■ Fiber Units

### Through-beam (Sold in Pairs)

#### E32-T11L

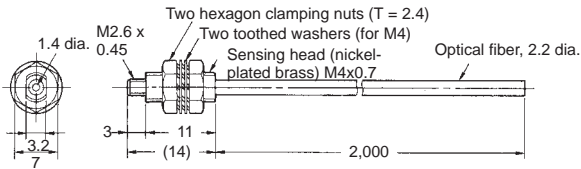

#### E32-T12L

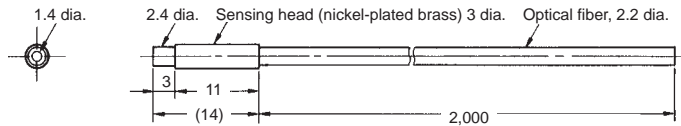

#### E32-T21L

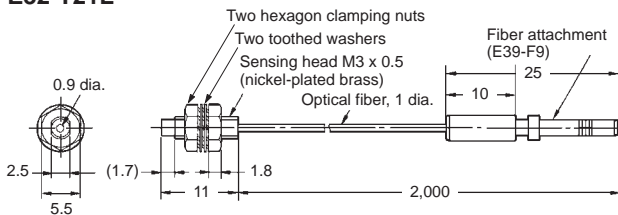

#### E32-T22L

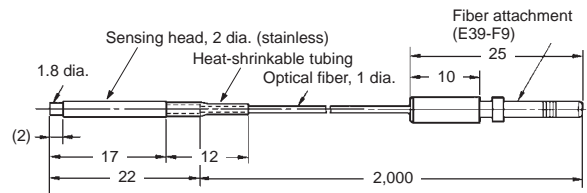

#### E32-TC200

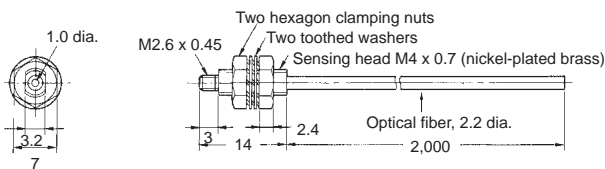

#### E32-TC200B

#### E32-TC200B4

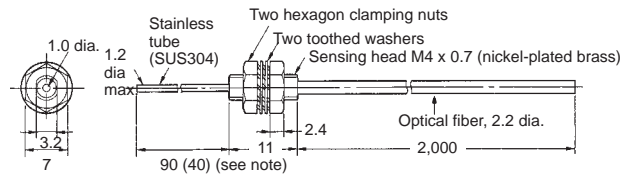

**Note:** The value in the parentheses is for the E32-TC200B4.

#### E32-T22

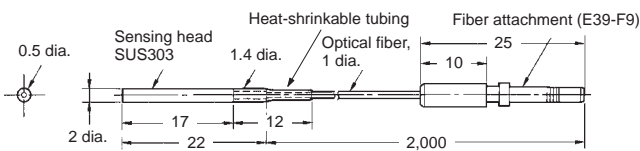

#### E32-TC200E

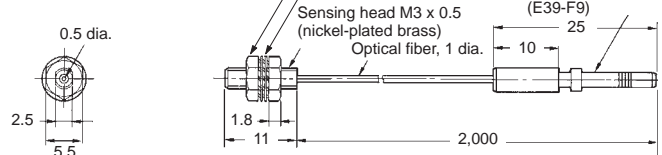

#### E32-TC200F E32-TC200F4

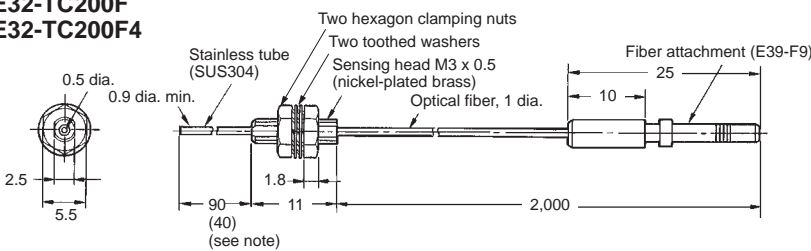

**Note:** The value in the parentheses is for the E32-TC200F4.

#### E32-TC200A

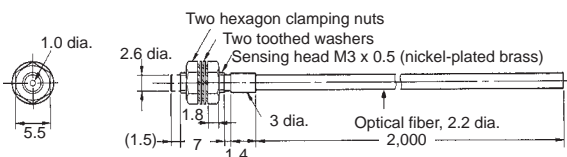

#### E32-T11

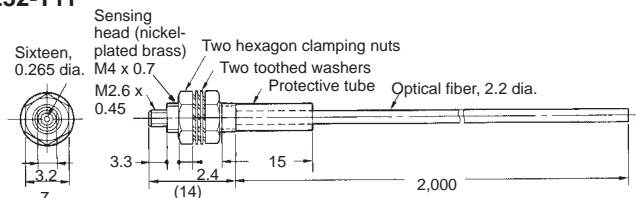

E32-T21

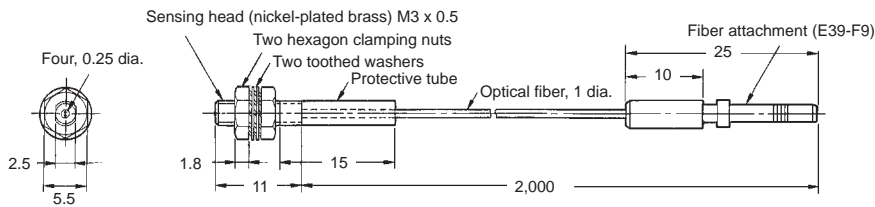

E32-TC200C

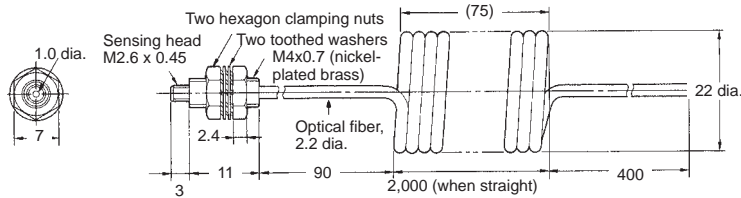

E32-TC200D  
E32-TC200D4

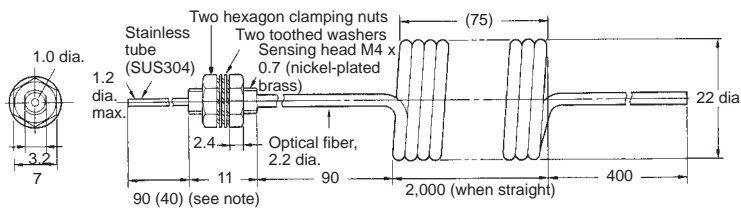

**Note:** The value in the parentheses is for the E32-TC200D4.

E32-T14L

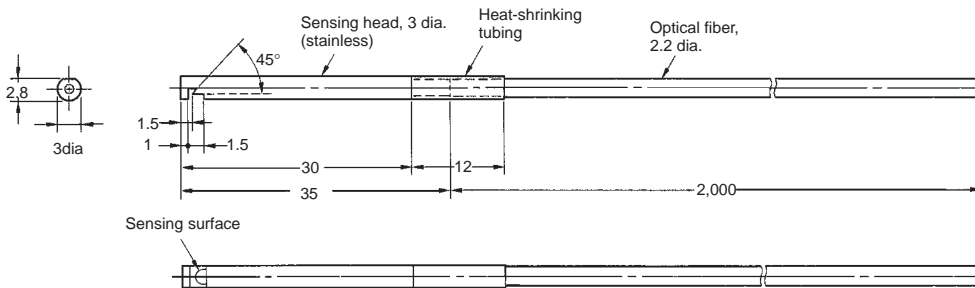

E32-T24

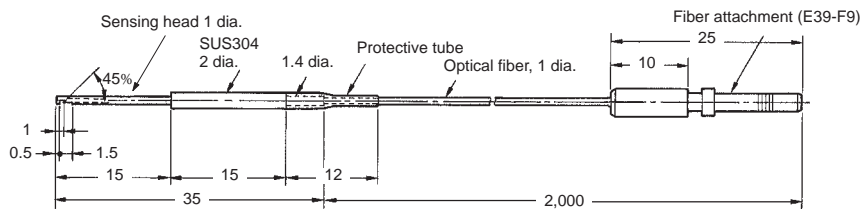

E32-T14

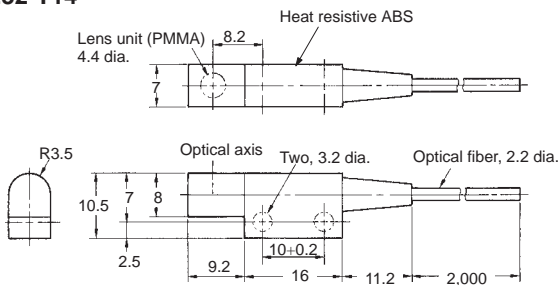

E32-T17L

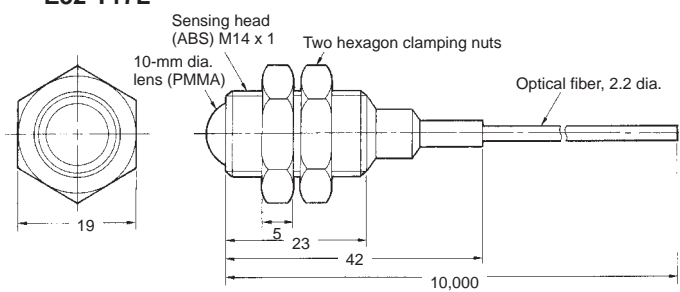

E32-T12F

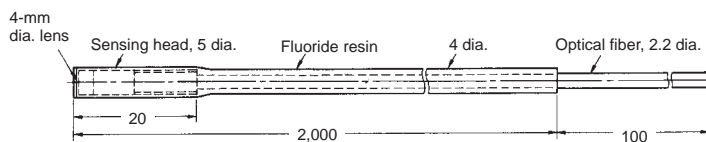

E32-M21

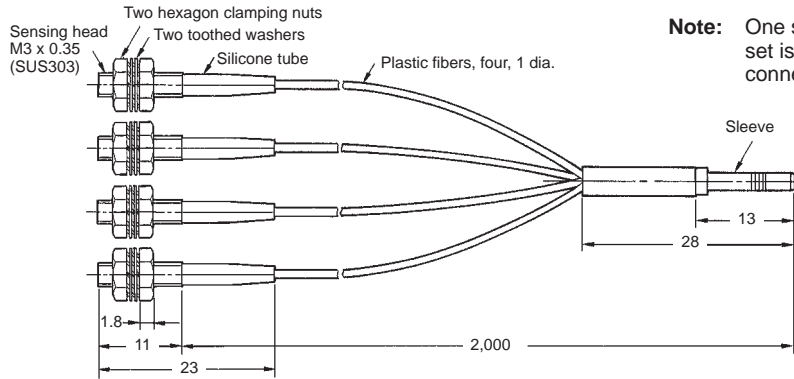

**Note:** One set of silicone tubes is black while the other set is gray for easy identification when they are connected to the light source and receiver.

E32-T51

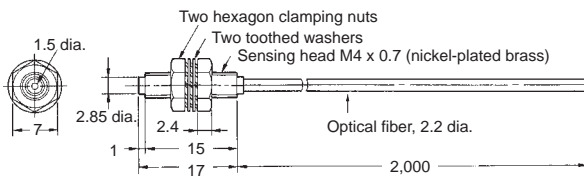

**Note:** Resistant temperature is 150°C.  
Resistant temperature is 130°C when used continuously.

E32-T61

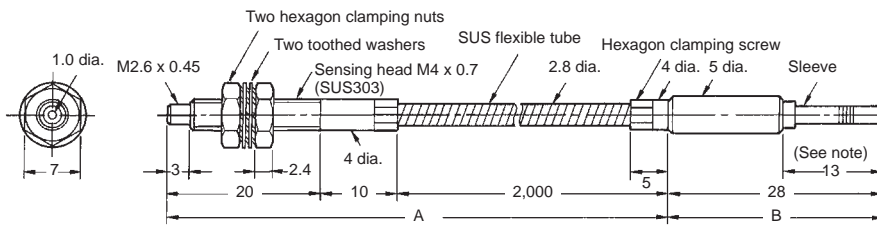

**Note:** Section A resists 300°C and section B (which is inserted to the Amplifier) resists 110°C. The operating temperature of section B must also be within the withstand temperature range of the Amplifier.

Reflective

E32-D11L

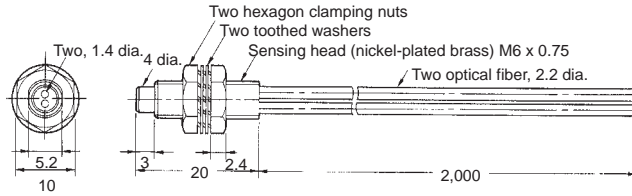

E32-D12

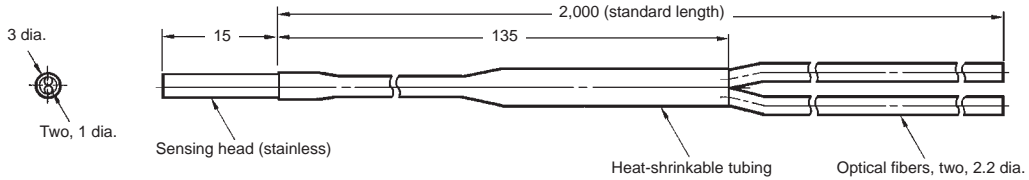

E32-D21L

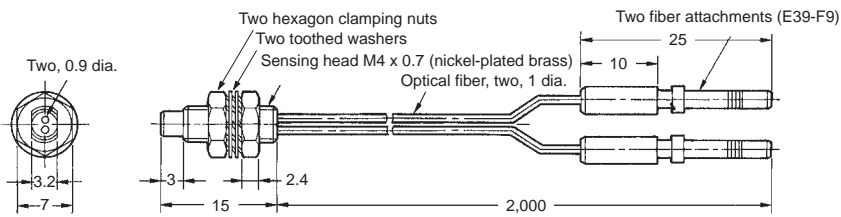

E32-D22L

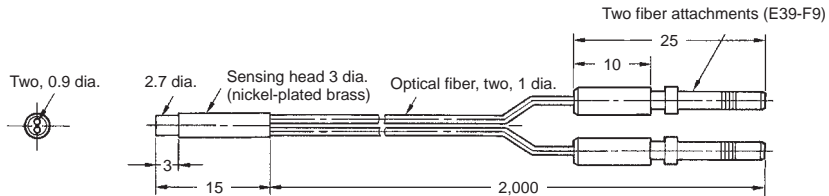

E32-DC200

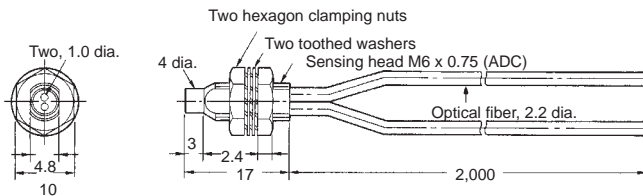

E32-DC200B

E32-DC200B4

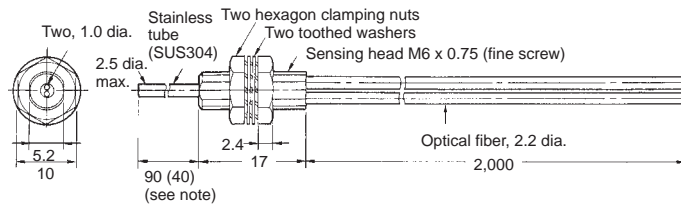

Note: The value in the parentheses is for the E32-DC200B4.

E32-DC200E

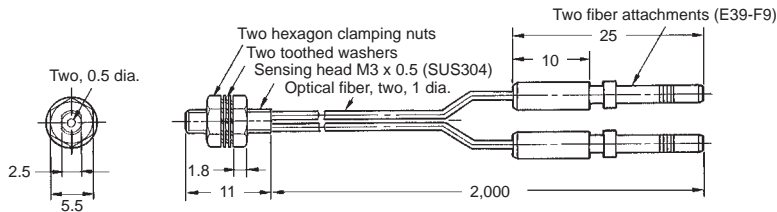

E32-DC200F  
E32-DC200F4

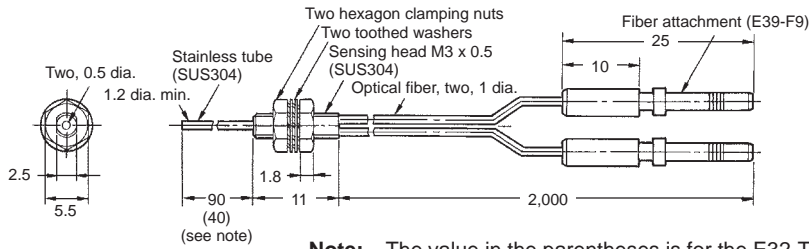

Note: The value in the parentheses is for the E32-TC200F4.

E32-D11

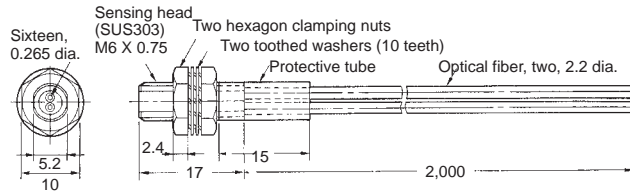

E32-D21

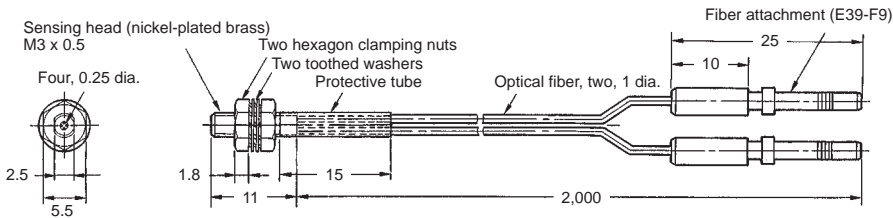

E32-DC200C

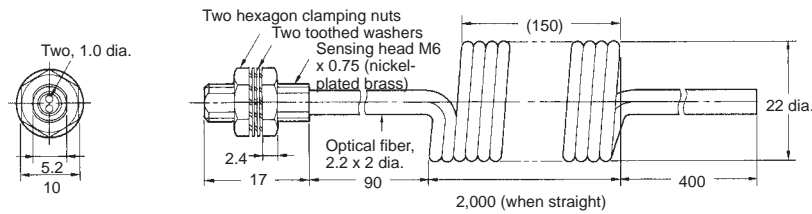

E32-DC200D  
E32-DC200D4

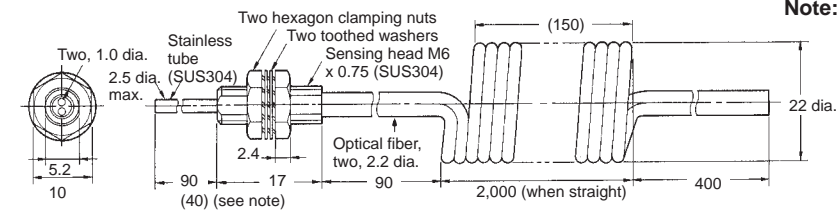

Note: The value in the parentheses is for the E32-DC200D4.

E32-DC9G  
E32-DC9G4

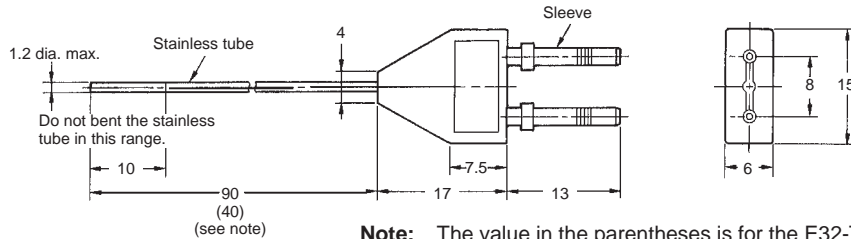

Note: The value in the parentheses is for the E32-TC200F4.

E32-D33

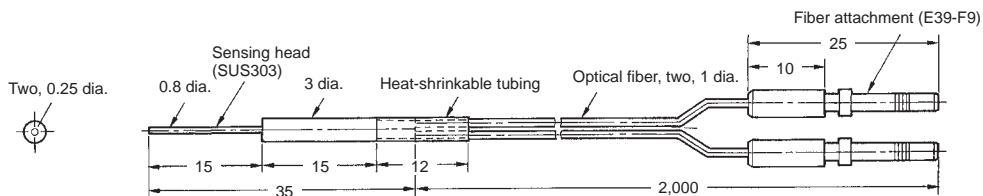



E32-CC200

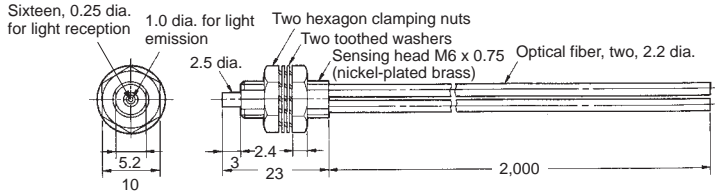

Note: The fiber for the light source is identified by a white line.

E32-D32

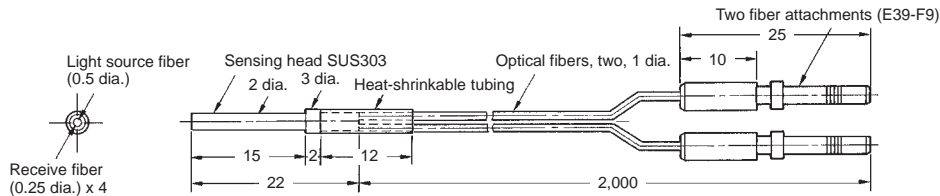

Note: The fiber for the light source is identified by a white line.

E32-D32L

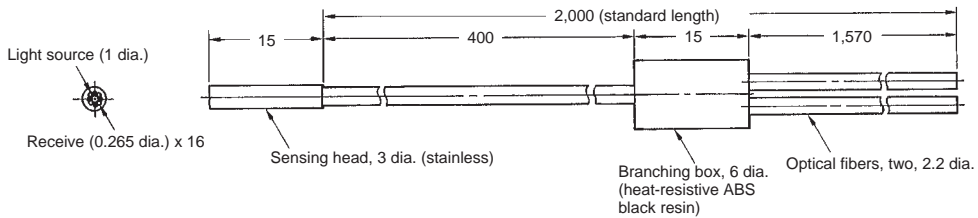

Note: The fiber for the light source is identified by a yellow dotted line.

E32-D14L

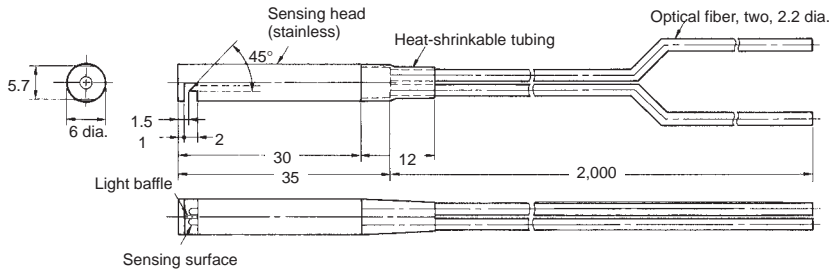

E32-D24

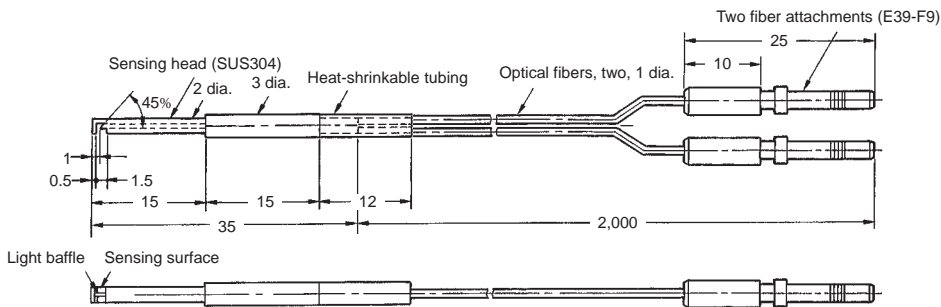

E32-D12F

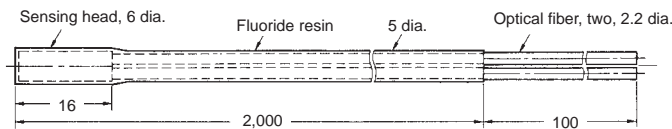

E32-D51

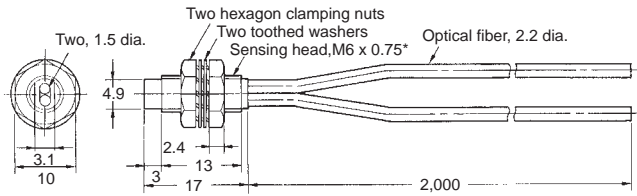

\*nickel-plated brass

**Note:** Resistant temperature is 150°C.  
Resistant temperature is 130°C when used continuously.

E32-D61

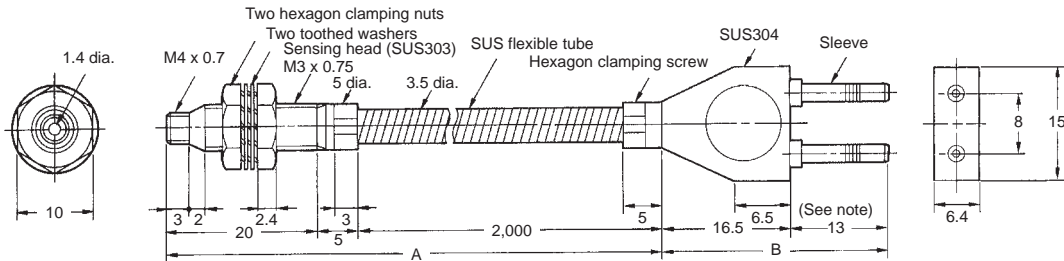

**Note:** Section A resists 300°C and section B (which is inserted to the Amplifier) resists 110°C. The operating temperature of section B must also be within the withstand temperature range of the Amplifier.

E32-D73

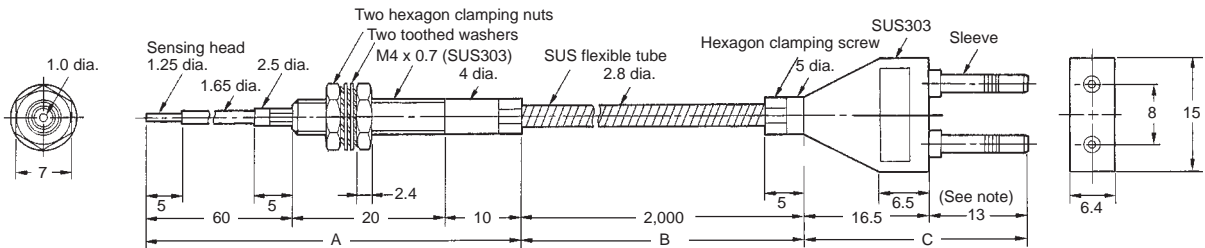

**Note:** Section A resists 400°C, section B resists 300°C, and section C (which is inserted to the Amplifier) resists 110°C. The operating temperature of section C must also be within the withstand temperature range of the Amplifier.

E32-R21

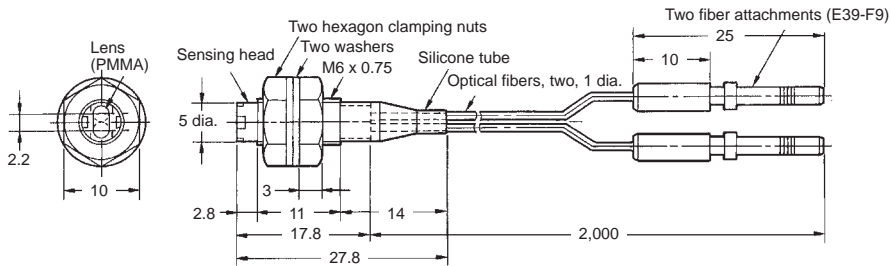

E32-R16

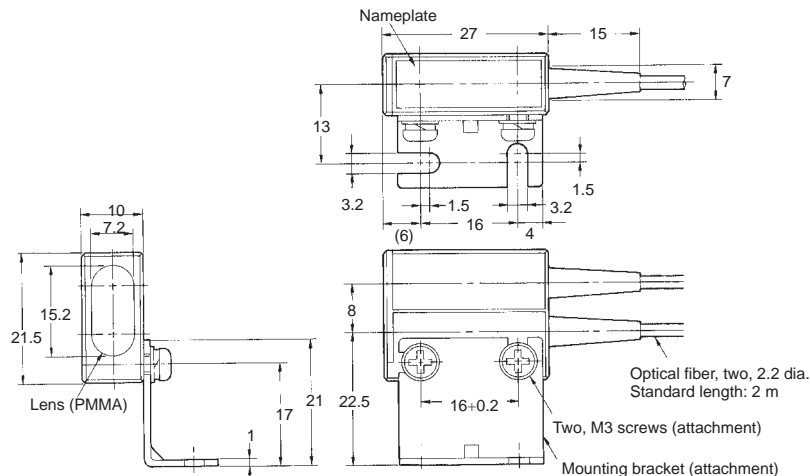

E32-L25

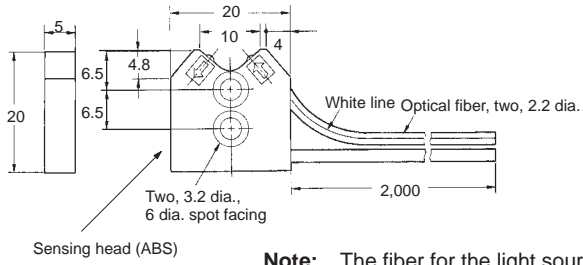

**Note:** The fiber for the light source is identified by a white line.

E32-L25A

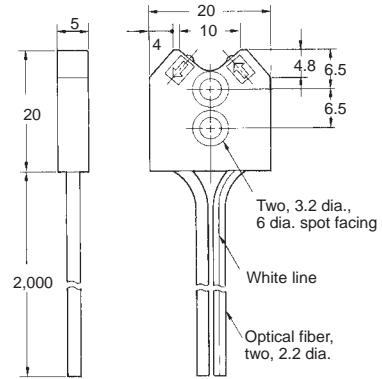

E32-L25L

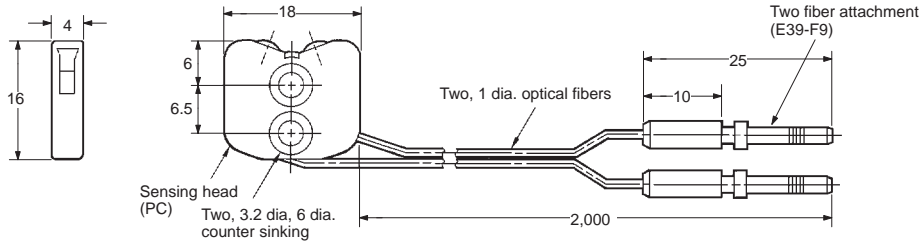

E32-L24L

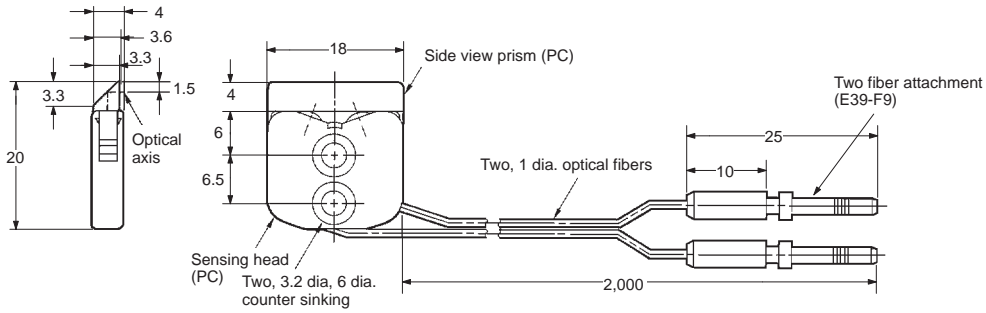

**Fine Through-beam**

E32-T22S  
E32-T24S

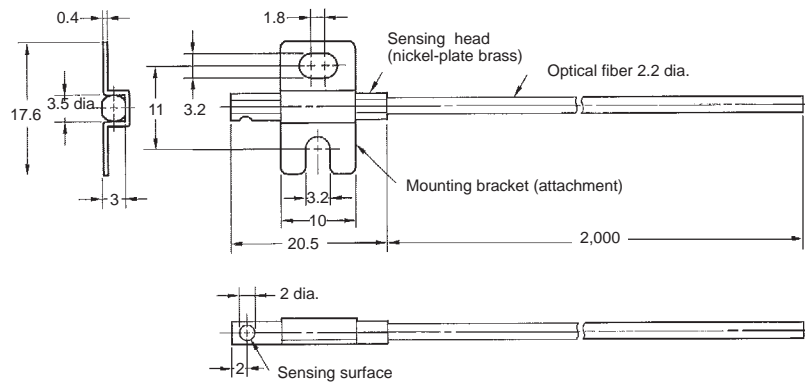

E32-T84S

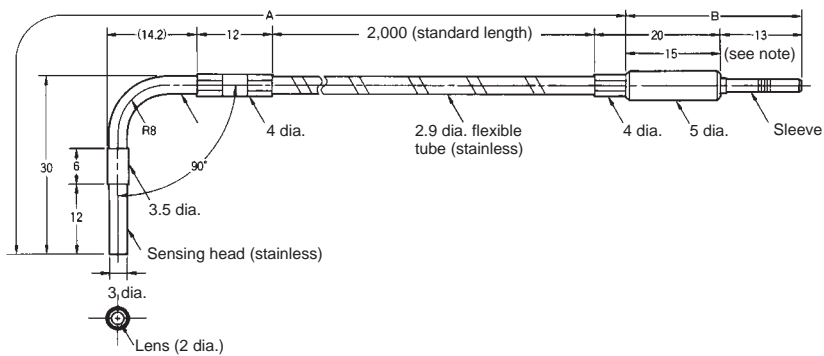

**Note:** Section A resists 200°C and section B (which is inserted to the Amplifier) resists 110°C. The operating temperature of section B must also be within the withstand temperature range of the Amplifier.

■ **Slot Fiber Units**

E32-G14

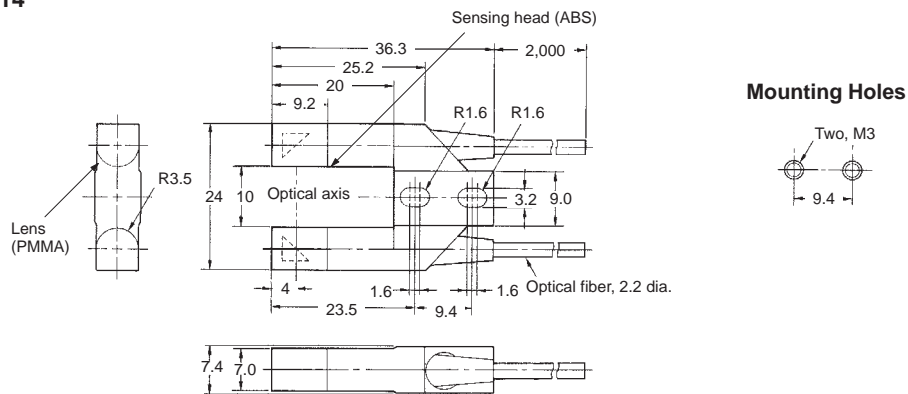

## ■ Liquid Level Fiber Units

### E32-D82F1/E32-D82F2 (Liquid Contact Model)

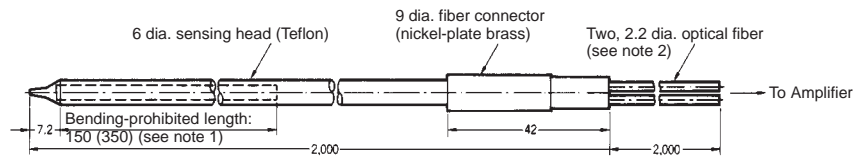

- Note:**
1. The value in the parentheses is for the E32-D82F2.
  2. Since the 2-m optical fiber on the Amplifier side is made of plastic, the fiber is trimmable.

### E32-L25T (Pipe Mounting Model)

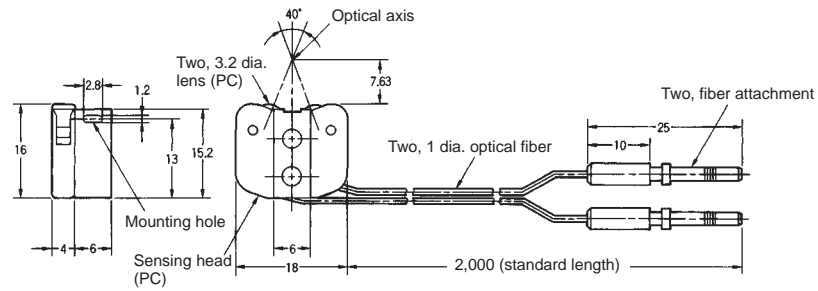

**E32-T16**

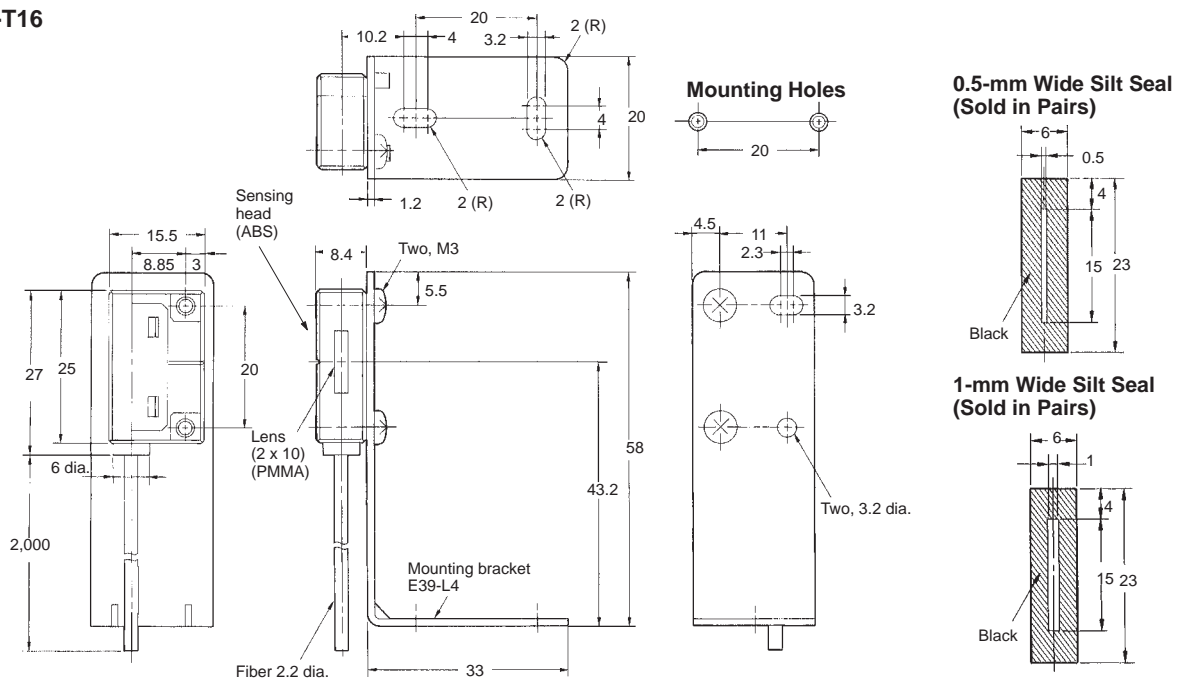

**E32-T16P**

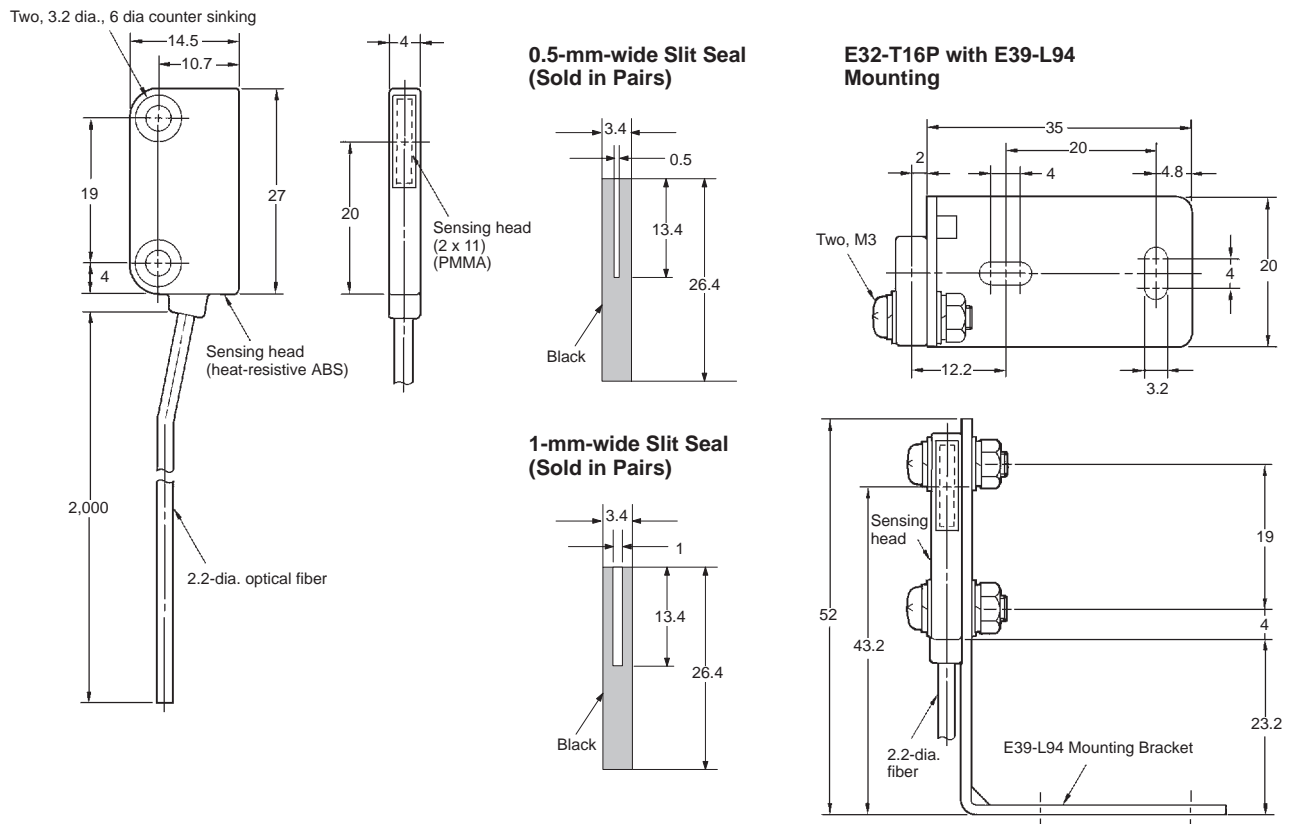

■ Amplifier

E3X-T11  
E3X-T21

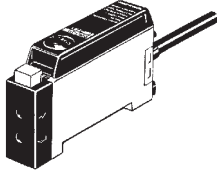

Cord: 2-m polyvinyl chloride-covered cord  
(4-mm dia., 3 cores\*)  
Weight: Approx. 100 g  
\*The cords for the E3X-T21 model has 6 cores.

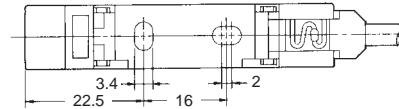
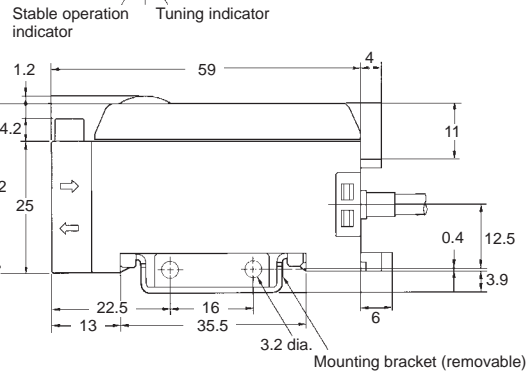
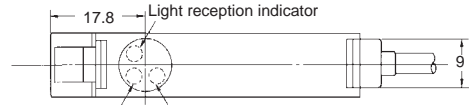
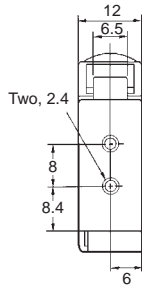

E3X-H11  
E3X-A□□  
E3X-F□□  
E3X-VG□□

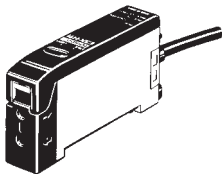

Cord: 2-m polyvinyl chloride-covered cord  
(4-mm dia., 5 cores\*)  
Weight: Approx. 100 g  
\*The cords for the E3X-A11, E3X-A41, and  
E3X-VG11 models have 3 cores.

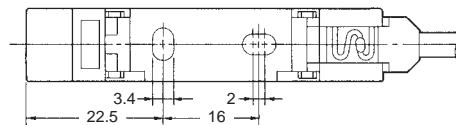
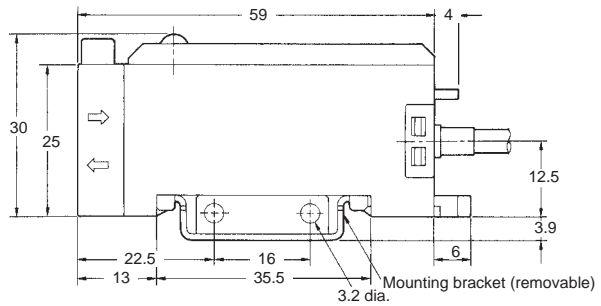
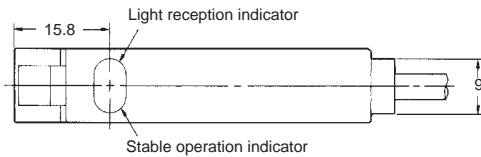
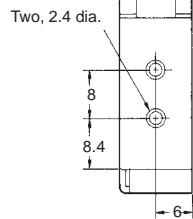

■ Reflector

Reflector (Small)  
E39-R3



**Note:** Mounting bracket is attached.

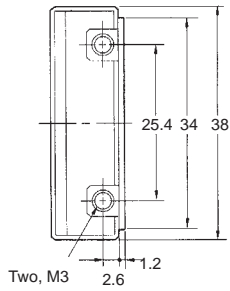
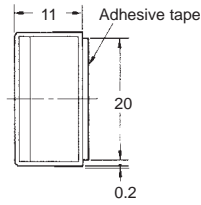
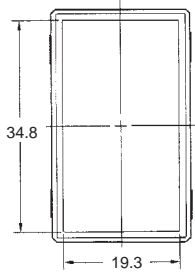

Reflector  
E39-R1

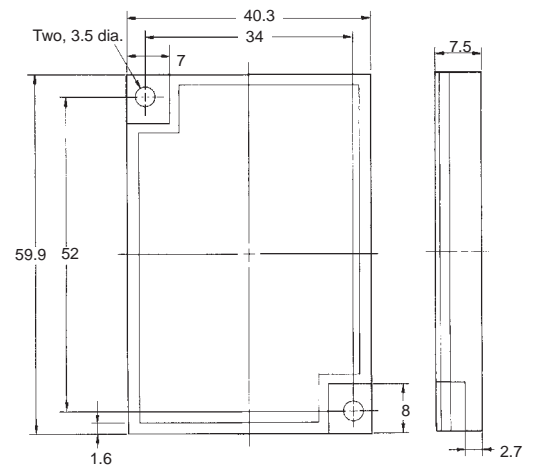

■ Attachments

E39-F1  
Lens Kit

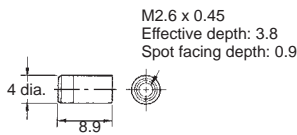

**Note:** One set includes two units.

E39-F2  
Side-view Attachment

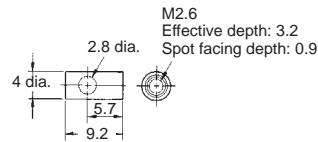

E39-F3  
Convergent Beam Conversion Kit

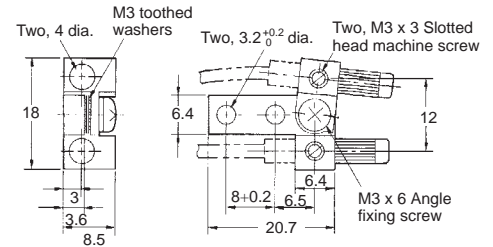

E39-F5  
Side-view Diffuse Reflective Conversion Kit  
(for the E32-TC200A)

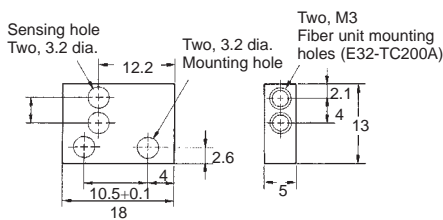

E39-F3A  
Reflective Lens Unit (for the E32-D32)

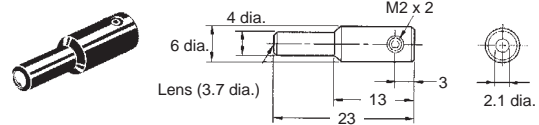



■ Protective Spiral Tubes

E39-F32A, E39-F32A5  
E39-F32B, E39-F32B5

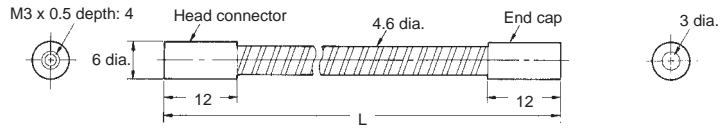
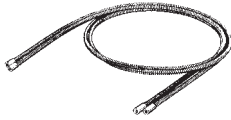

- Note:**
1. L is as follows:  
E39-F32A and E39-F32B: 1,000  
E39-F32A5, E39-F32B5: 500
  2. A pair of E39-F32A(5)'s is sold as E39-F32B(5).

E39-F32C, E39-F32C5

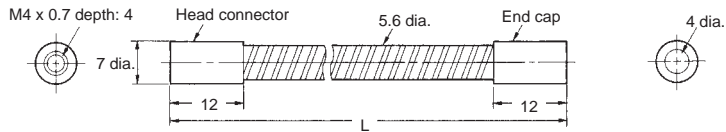

- Note:** L is as follows:  
E39-F32C: 1,000  
E39-F32C5: 500

E39-F32D, E39-F32D5

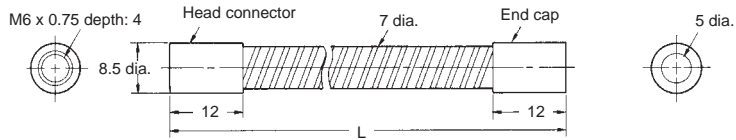

- Note:** L is as follows:  
E39-F32D: 1,000  
E39-F32D5: 500

■ Accessories

E39-F4 Fiber Cutter

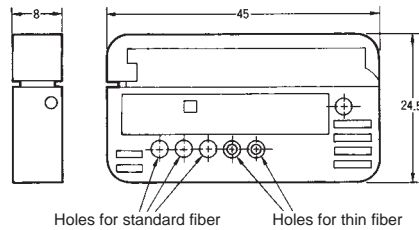
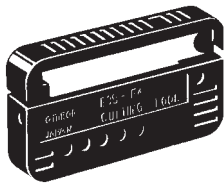

E39-F9 Attachment for Thin Fiber

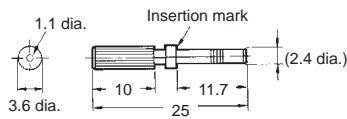

**Note:** One set includes two Units.

E39-F10 Fiber Connector

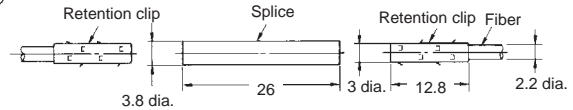
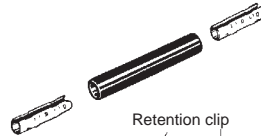

### E39-G3 Manual Sensitivity Adjustment Knob

**Note:** Cannot be used with the E3X-T□□.

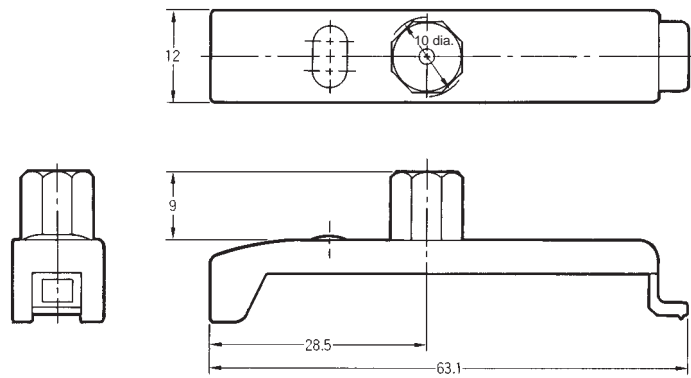

### E39-G4 Protective Cover

**Note:** Cannot be used with the E3X-T□□.

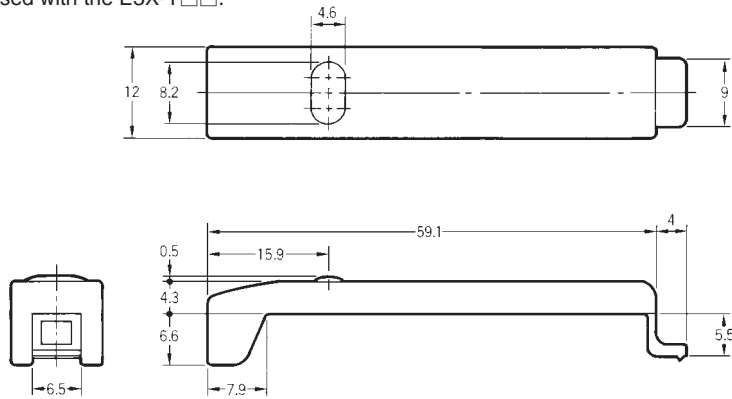

# Installation

## ■ Connections

Connection with S3D2 Sensor Controller

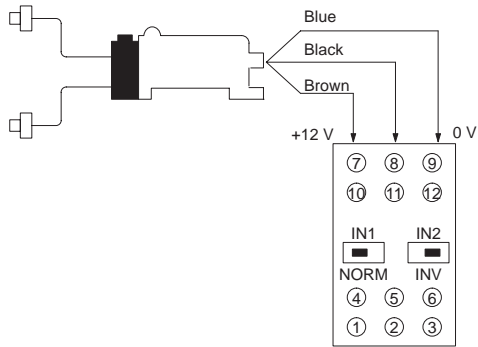

Connection with S3D8 Sensor Controller

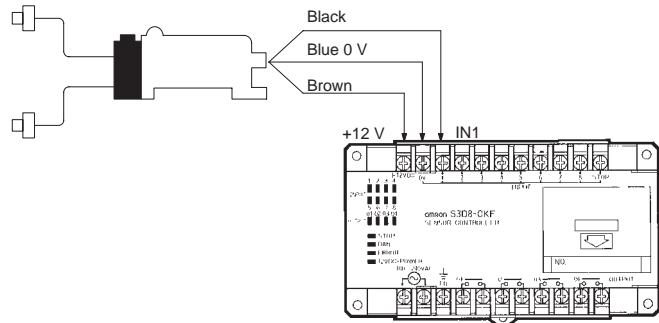

**Note:** A maximum of two E3X Optical Fiber Photoelectric Sensors can be connected.

**Note:** A maximum of eight E3X Optical Fiber Photoelectric Sensors can be connected.

Power supply voltage	Output	Functions	NPN input	PNP input
100 to 240 VAC	Relay	AND, OR	S3D2-AK-US	S3D2-AKB-US
		AND, OR, and timer	S3D2-CK-US	S3D2-CKB-US
		Flip-flop	S3D2-BK-US	---
	Transistor	AND, OR, and timer	S3D2-CC-US	S3D2-CCB-US

## Precautions

### ■ Fiber Units

#### Tightening Force

The tightening force applied to the Fiber Unit should be as follows:

#### Screw-mounting Model

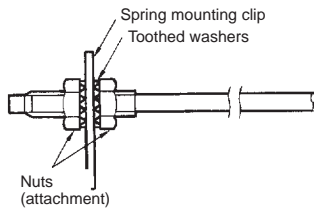

#### Column Model

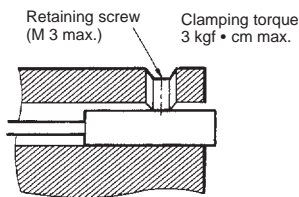

Fiber units	Clamping torque
M3/M4 screw	8 kgf • cm max. (0.78 N • m)
M6 screw	10 kgf • cm max. (0.98 N • m)
2-mm dia. column	3 kgf • cm max. (0.29 N • m)
3-mm dia. column	3 kgf • cm max. (0.29 N • m)
E32-D14L	10 kgf • cm max. (0.98 N • m)
E32-T12F	8 kgf • cm max. (0.78 N • m)
E32-D12F	8 kgf • cm max. (0.78 N • m)
E32-T16	5 kgf • cm max. (0.49 N • m)
E32-R21	6 kgf • cm max. (0.59 N • m)
E32-M21	Up to 5 mm to the tip: 5 kgf • cm max. (0.49 N • m) Up to 5 mm from the tip: 8 kgf • cm max. (0.78 N • m)
E32-L25A	8 kgf • cm max. (0.78 N • m)

Use a proper-sized wrench.

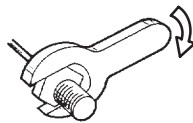

#### Fiber Connection and Disconnection

The E3X Amplifier has a push lock. Connect or disconnect the fibers to or from the E3X Amplifier using the following procedures:

##### 1. Connection

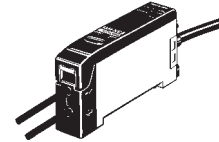

Insert the fibers into the E3X Amplifier and press the push lock until the Amplifier clicks to lock the fibers. The fibers will have insertion marks when they are cut with the E39-F4 (Fiber Cutter). The portion from the tips to the insertion mark should be inserted to the E3X.

##### 2. Disconnection

Be sure to press the push lock again to unlock before pulling out the fiber, otherwise the fiber may be deteriorated.

#### Fiber Insertion

If the portion from the tip to the insertion mark of the fibers are not inserted into the Amplifier Unit, the sensing distance will be reduced.

#### 2.2-mm dia. Fiber

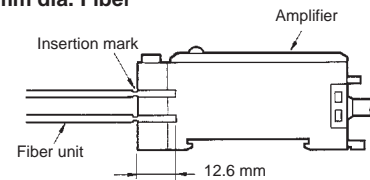

#### Thin Fiber with the E39-F4 Attachment

The portion from the tips to the insertion mark should be inserted into the E3X.

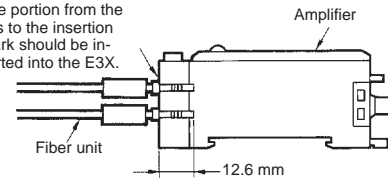

#### Fiber with Fixed Length

The portion from the tips to the insertion mark should be inserted into the E3X.

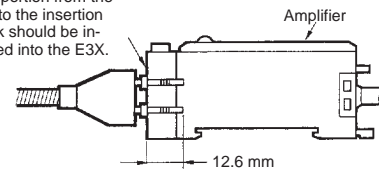

**Cutting Fiber**

Insert a fiber into the Fiber Cutter and determine the length of the fiber to be cut.

Press down the Fiber Cutter in a single stroke to cut the fiber.

When the fiber is cut, an insertion mark is inscribed on the fiber.

For a 2.2-mm dia. standard fiber only.

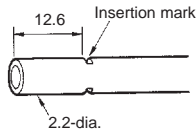

Insert a fiber into the Fiber Cutter in the direction indicated by the arrow (refer to the following figure).

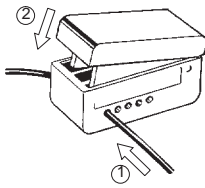

The cutting holes cannot be used twice. If the same hole is used twice, the cutting face of the fiber will be rough and the sensing distance will be reduced. Always use an unused hole.

Use either one of the two holes on the right (refer to the following figure) to cut a thin fiber as follows:

1. An attachment is temporarily fitted to a thin fiber before shipment.

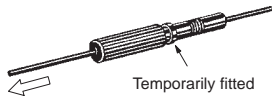

2. Secure the attachment after adjusting the position of it in the direction indicated by the arrow.
3. Insert the fiber into the E39-F4 to cut.

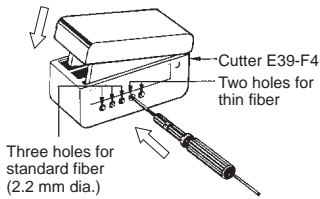

**Note:** Insert the fiber in the direction indicated by the arrow.

**Connection**

Do not pull or press the Fiber Units. The Fiber Units have a withstand force of 1 kg or 3 kg (pay utmost attention because the fibers are thin).

Do not bend the Fiber Units beyond the permissible bending radius. Do not bend the edge of the Fiber Units.

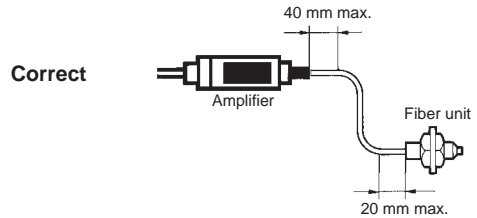

Do not apply excess force on the Fiber Units.

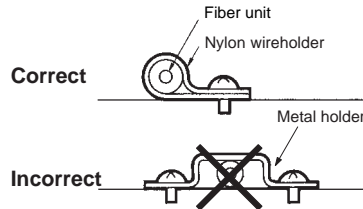

The Fiber Head could be broken by excessive vibration. To prevent this, the following is effective:

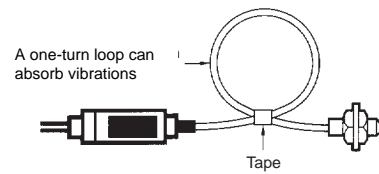

## Bending Radius

### E39-F11 Sleeve Bender

The bending radius of the stainless tube should be as large as possible. The smaller the bending radius becomes, the shorter the sensing distance will be.

Insert the tip of the stainless sleeve to the Sleeve Bender and bend the stainless sleeve slowly along the curve of the Sleeve Bender (refer to the figure).

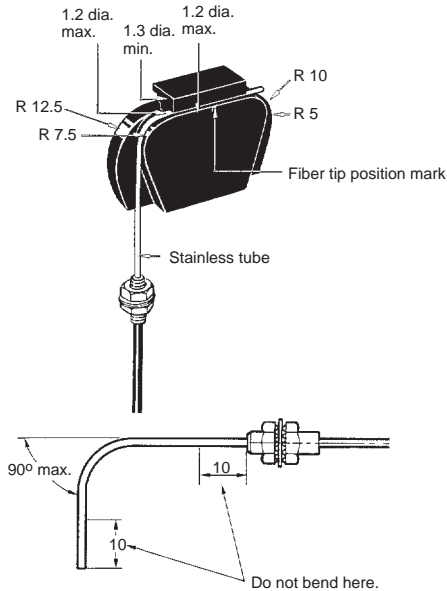

## Handling

### E32-D51/-T51 Heat-resisting Fiber

The bending radius of the fibers should be 35 mm min.

Connecting fibers via the E39-F10 Fiber Connector is not possible.

The withstand temperature of the Heat-Resisting Fibers is 150°C max. In continuous operation, the ambient temperature should be 130°C max.

### E32-T14/-T51

If the sensor is ON because some object in front of the lenses reflects light, attach the black seals (sold together) to the lenses.

### E32-T14/-G14

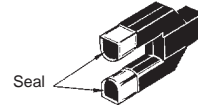

### E32-L25 (A) Wafer Sensor

Insert the fiber with a white line into the light projection side of the Amplifier.

The tightening force of the sensor head is 8 kgf • cm (0.75 N • m).

Avoid places where water could be sprayed onto the E32-L25(A).

### E32-T16 Slit Seal (Attachment)

Peel the E32-T16 Slit Seal off the ground paper and affix the Slit Seal to the sensing face of the sensor so that the corners of the Slit Seal fit in with the corners of the sensing face. To sense an object at a distance of 30 cm max., a 0.5-mm wide Slit Seal must be used.

### E32-T16 Sensing Head

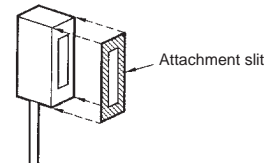

## Amplifier Units

### Mounting

#### Mounting

1. Mount the front part on the mounting bracket (sold together) or a DIN rail.
2. Press the back part onto the mounting bracket or the DIN rail.

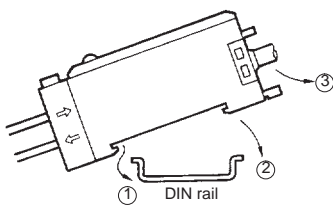

#### Dismounting

By pulling back the lock (yellow) on the bottom with a flat blade screwdriver, the Amplifier can be dismounted with ease.

In the case of side mounting, attach the mounting bracket on the Amplifier first, and secure the Amplifier with M3 screws and washers. The diameter of the washers should be 6 mm max.



### Others

When power is off:

The moment power is turned off, the E3X could output a pulse signal which could affect the operation of the devices connected to it. This will happen more often if power is supplied to the E3X from an external power supply, thus affecting the connected timer and counter. Use a built-in power supply as much as possible to avoid this.

If power is supplied to a photoelectric sensor through a cord that is wired together with other power lines in the same duct, the cord will be influenced by the power lines and malfunctioning of the photoelectric sensor or damage could result. Wire the cord separately or use a sealed cord to supply power to the photoelectric sensor.

In the case of the cord is extended, use a wire with 0.3 mm<sup>2</sup> max.. The total length of the cord should be 100 m max.

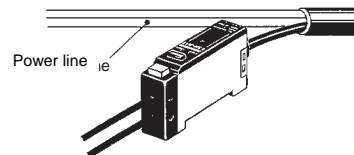

#### Power supply:

If a standard switching regulator is used as a power supply, the frame ground (FG) terminal and the ground (G) terminal must be grounded, or otherwise the E3X can malfunction, influenced by the switching noise of the power supply.

The supplied voltage must be within the rated voltage range. Unregulated full- or half-wave rectifiers must not be used as power supplies.

Do not use a hammer to hit the Amplifier when mounting or the Amplifier will loose watertightness.

## ■ Attachment Units

### Applications

#### E39-F10 Fiber Connector

Use the following procedure (refer to the figure) to connect fibers via the Fiber Connector.

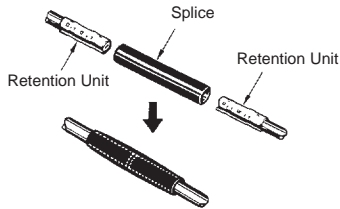

Each fiber should be as close as possible before they are connected.

Sensing distance will be reduced by approximately 25% when fibers are connected.

Only fibers with 2.2 mm dia. can be connected.

#### Protective Spiral Tube

Insert a fiber to the Protective Spiral Tube from the head connector side (screwed) of the tube.

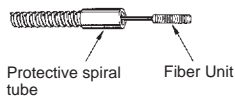

Push the fiber into the Protective Spiral Tube. The tube should be straight so that the fiber is not twisted when inserted. Then turn the end cap of the spiral tube.

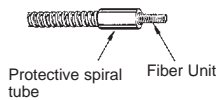

Secure the Protective Spiral Tube on a suitable place with the attached nut.

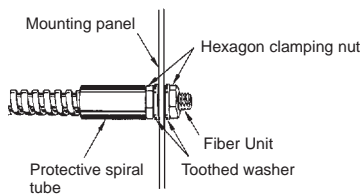

Use the attached saddle to secure the end cap of the Protective Spiral Tube. To secure the Protective Spiral Tube at a position other than the end cap, apply tape to the tube so that the portion becomes thicker in diameter.

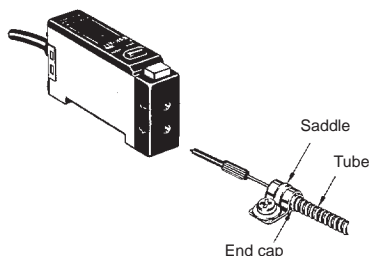

#### E39-F3A Reflective Unit Lens

When the E39-F3A is attached to the fiber, the E3X can sense the light reflected from the interior of the E39-F3A. If this happens, adjust the sensitivity of the E3X Amplifier with Sensitivity Adjustor.

Place a sensing object or white paper at the sensing distance set and adjust the insertion length of the Fiber Unit to the E39-F3A so that the light spot is as small as possible. Then fix the position of the Fiber Unit with the hexagonal wrench (attachment)

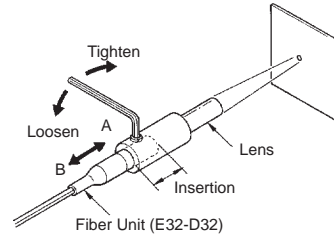

A: The focus is farther than the E39-F3A.  
B: The focus is closer than the E39-F3A

## ■ E39-G3 Sensitivity Adjustor

1. Remove the cover of the E3X.
2. Attach the E39-G3 (refer to the figure).

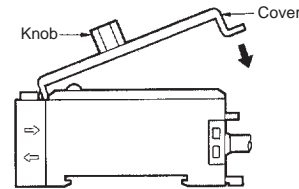

3. After the cover is attached to the case, turn the knob of the E39-F3A clockwise or counterclockwise once. To confirm that the knob has been set properly, turn the knob clockwise or counterclockwise until you hear a click (8 turns max. are necessary).

**Note:** E3X loses watertightness if E39-G3 is attached (the enclosure rating will be IP50).

**ALL DIMENSIONS SHOWN ARE IN MILLIMETERS.**

To convert millimeters into inches, multiply by 0.03937. To convert grams into ounces, multiply by 0.03527.

Cat. No. E215-E1-3 **In the interest of product improvement, specifications are subject to change without notice.**

## **OMRON Corporation**

Systems Components Division H.Q.  
28F Crystal Tower Bldg.  
1-2-27, Shiromi, Chuo-ku,  
Osaka 540 Japan  
Phone: 06-949-6012 Fax: 06-949-6021

Printed in Japan  
0196-2M (0691) a