



Temperature Controller

E5CS-X

DIN-sized (48 × 48 mm) Temperature Controller Features Automatic P (proportional action) Tuning Function

- Accurate to ±0.5% of full scale.
- Multiple temperature ranges allow easy selection for application.
- Field-selectable temperature ranges in °C and °F.
- Easy-to-read, 11-mm high LED digital display.
- Tamper-proof setting, faulty-sensor detection, and controller diagnostics.
- 8-function alarm available.
- Nonvolatile memory.
- Field-selectable control mode (ON/OFF or PID).



Ordering Information

Thermocouple Type

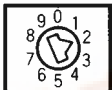
Input	K (CA) Chromel-alumel						J (IC) Iron-constantan				
	 Standard temperature ranges (switch selectable)	200	300	400	500	600	999	999	200	300	400
Set no.	0	1	2	3	4	5	6	6	7	8	9
Temperature unit (selectable)	°C	°C	°C/°F	°C/°F	°C/°F	°C/°F	°F	°C	°C	°C/°F	°C/°F
Measurement unit	1										
Control mode	ON/OFF or PID										
Without alarm	Relay output	E5CS-RKJX									
	Voltage output	E5CS-QKJX									
With alarm	Relay output	E5CS-R1KJX									
	Voltage output	E5CS-Q1KJX									

Platinum Resistance Thermometer Type

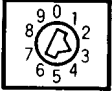
 <p>Standard temperature ranges (switch selectable)</p>		Input	Platinum resistance thermometer (Pt: 100 Ω, JIS and DIN standard types)							
		500 400 300 200 100 0 -100								
Set no.		0	1	2	3	4	5	6	7	8
Temperature unit (selectable)		°C	°C	°C/°F	°C/°F	°C/°F	°C	°C	°C/°F	°C/°F
Measurement unit		1	0.1	1	0.1	1				
Control mode		ON/OFF or PID								
Without alarm	Relay output	E5CS-RPX								
	Voltage output	E5CS-QPX								
With alarm	Relay output	E5CS-R1PX								
	Voltage output	E5CS-Q1PX								

Thermistor Type

 <p>Standard temperature ranges (switch selectable)</p>		Input	THE element interchangeable thermistor									
		500 400 300 200 100 0 -100										
Set no.		0	1	2	3	4	5	6	7	8	9	
Temperature unit (selectable)		°C					°F					
Measurement unit		1										
Control mode		ON/OFF or PID										
Without alarm	Relay output	E5CS-RGX										
	Voltage output	E5CS-QGX										
With alarm	Relay output	E5CS-R1GX										
	Voltage output	E5CS-Q1GX										

The functions can be factory-set for shipment as shown in the table below, depending on the suffix attached to the model number when you place your order. Two suffixes are selectable: "-DIN" or "-F".

Example: E5CS-RKJX-DIN

_____ Suffix

Suffix		None	-DIN	-F
Standard temperature range	K(CA)/J(IC)	2 (0 to 400)	8 (0 to 400)	2 (0 to 400)
	PT	3 (0.0 to 99.9)	3 (0.0 to 99.9)	3 (0.0 to 99.9)
	THE	1 (-50 to 50)	1 (-50 to 50)	1 (-50 to 50)
Temperature unit (selectable)		°C	°C	°F
Control mode		ON/OFF	ON/OFF	ON/OFF
Proportional period	Relay output	20 s	20 s	20 s
	Voltage output		2 s	
Control output		Reverse operation	Reverse operation	Reverse operation
Input shift		Cannot be set	Cannot be set	Cannot be set
Temperature sensor standard		JIS (ISO)	DIN	JIS (ISO)
Alarm mode		2 (upper-limit)	2 (upper-limit)	2 (upper-limit)

The functions can be factory-set in accordance with your needs. The above settings, however, can be easily changed using the internal DIP switch. For details on the DIP switch settings, refer to *Function Setting*.

■ Accessories (Order Separately)**Protective Cover Y92A-48**

The protective cover protects the front panel, particularly the setting section, against dust, dirt, and water drip. It also prevents the set values from being altered due to accidental contact with the setting keys.

Y92A-48
Protective Cover

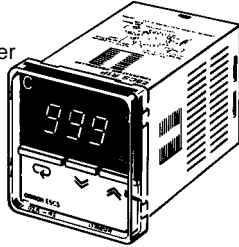

Specifications

■ Ratings

Supply voltage		100 to 240 VAC 50/60 Hz
Operating voltage range		85 to 110% of rated supply voltage
Power consumption		Approx. 7 VA
Control output	Relay	3 A 250 VAC (resistive load), SPDT
	Voltage	20 mA 12 VDC, w/short-circuit protection circuit
Alarm output		1 A 250 VAC (resistive load), SPST-NO

■ Characteristics

Setting accuracy	±0.5% of full scale, ±1 digit max.
Indication accuracy	Set value coincides with indicated value, since no relative error exists between these values.
Hysteresis	0.2% of full scale (during ON/OFF control)
Proportional band	3% to 20% (automatically adjusted according to the rise time of the controlled system)
Reset time	4 minutes (fixed)
Rate time	0.4 minutes (fixed)
Alarm output setting range	0 to full scale for all modes except the absolute-value alarm mode (see note)
Alarm output setting range (Absolute-value alarm mode)	Same as switch-selectable standard temperature ranges shown at the top of the tables in <i>Ordering Information</i>
Proportional period	2/20 seconds
Sampling period	500 ms (Output change period: 2 seconds; Indication change period: 2 seconds)
Insulation resistance	20 MΩ min. (at 500 VDC)
Dielectric strength	2,000 VAC, 50/60 Hz for 1 minute (between current-carrying terminals of different polarity)
Vibration resistance	Malfunction: 2 to 55 Hz, 2 G for 10 minutes each in X, Y, and Z directions Destruction: 10 to 55 Hz, 0.75 mm double amplitude for 2 hours each in X, Y, and Z directions
Shock resistance	Malfunction: 100 m/s ² , in 6 directions, 3 times each Destruction: 300 m/s ² , in 6 directions, 3 times each
Ambient temperature	Operating: -10 to 55°C Storage: -25 to 65°C
Humidity	35% to 85% RH
Degree of protection	IEC 144 Front panel: IP50 Rear panel: IP30 Terminals: IP00
Life expectancy	Mechanical: 10,000,000 operations min. (relay output) Electrical: 100,000 operations min. (relay output)
Weight	Approx. 170 g (main enclosure only)

Note: Set values must be within the allowable range limits for alarm values, control outputs, etc. If a set value does not satisfy the following condition, select another range:

$$\text{Minimum of temperature range} \leq T_{\text{set}} \pm X \leq \text{Maximum of temperature range}$$

where:

T_{set} =Set temperature, and

X=Alarm value.

Nomenclature

LED Deviation Indicators

△ lights when the present temperature is higher than the set temperature, and ▽ lights when it is lower. The □ indicator lights in green if the deviation is within ±1% of the full scale.

Main Display

Sequentially displays the present temperature, set temperature, and an alarm value (in that order) each time the temperature indication switching (↻) key is pressed.

Control Output Indicator

Lights while the control output is being produced.

Mode Indicator

SP lights while the set temperature is displayed on the main display, and AL lights while an alarm value is being displayed.

Alarm Output Operation Indicator

Lights when the alarm output relay is energized.

Protection Key

When program protection is selected using the internal DIP switch, the upward and downward setting keys are locked. However, authorized personnel may change values using the upward and downward setting keys by holding down hidden protection key.

Upward Setting Key

When pressed, increases the set temperature/alarm value. Successively increases the value when held down.

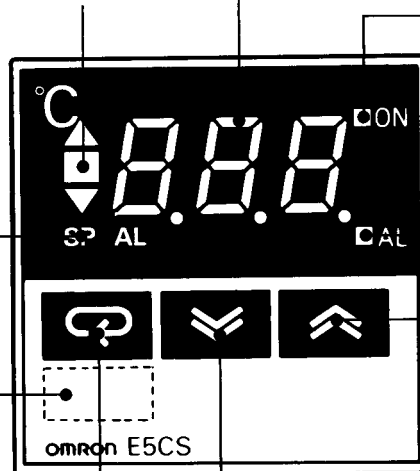

Downward Setting Key

When pressed, decreases the set temperature/alarm value. Successively decreases the value when held down.

Temperature Indication Switching Key

Each time pressed, changes the value displayed on the main display in the following sequence.

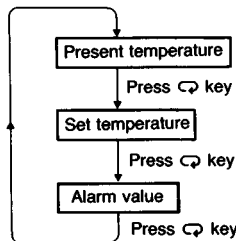

Operation

Temperature Setting

Press the temperature indication switching key until the SP indicator lights. Then set the desired temperature value using the upward and downward setting keys.

Alarm Setting

Press the temperature indication switching key until the AL indicator lights. Then set the desired alarm value in units of °C or °F. If the present temperature reaches the set alarm value, alarm output will be enabled.

Function Setting

The various functions of the Temperature Controller are set using the switches on the internal mechanism. To gain access to these switches, the internal mechanism must be first drawn out from the housing. Push the tab on the underside of the housing, and pull out the mechanism.

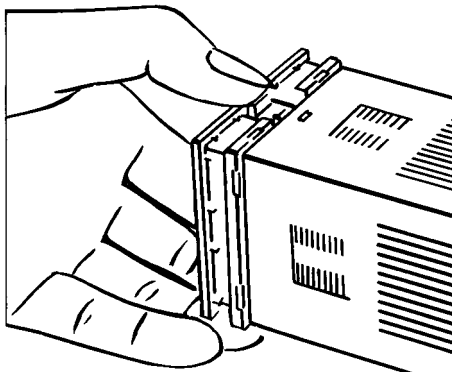

Select the desired temperature range using the temperature range selector switch (rotary DIP type). Eight or nine temperature ranges can be selected depending on the model. The set temperature is automatically changed when the temperature range is changed. Be sure to confirm the set temperature.

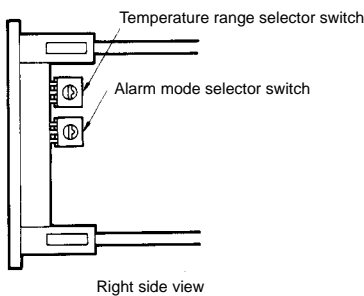

Temperature unit (C° or F°), where a choice is available, is selected using pin 6 of the internal DIP switch which is also used for other settings, such as the control mode and sensor compensation.

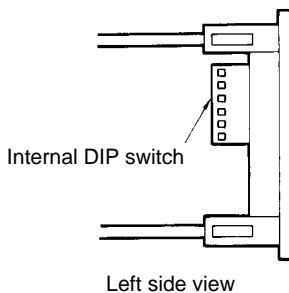

Sensor Failure

The error message “FFF” or “-- --” will appear on the main display if the temperature sensor, such as the thermocouple or platinum resistance thermometer, short-circuits or breaks. (Refer to *Error Messages* for details of the messages displayed.)

Note: Neither the set alarm value is displayed nor the AL indicator lights with the internal alarm mode selector switch set to 0 or 9. The alarm mode selector switch is provided inside the housing, and is positioned differently on each model.

The procedures for making actual settings are given below.

Setting the Temperature Range

Set the desired temperature range by using the temperature range selector switch (“Set no.” setting in the tables below). Eight or nine temperature ranges can be selected depending on the model.

Thermocouple Type

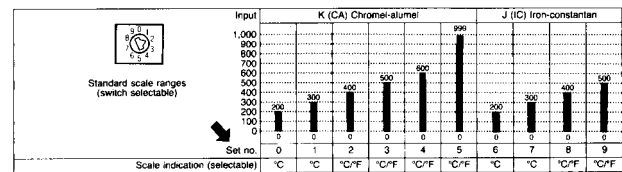

The display can indicate temperatures 10% beyond each of the set ranges.

Platinum Resistance Thermometer Type

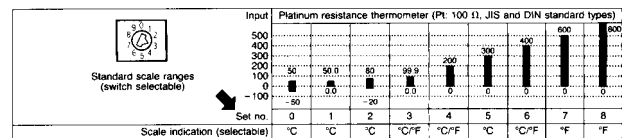

Do not set the selector switch to “9.” Doing so will result in the error message “FFF” or “-- --” being displayed.

- Note:**
- The unit in which the temperature can be set is multiplied by 10 when the temperature range is changed from 0.0 to 50.0 or 0.0 to 99.9 to a range in which the temperature can be set in 1° units. Conversely, if the temperature range is changed from one in which the temperature can be set in 1° units to a range of 0.0 to 50.0 or 0.0 to 99.9, the unit is decreased to 1/10 of the original unit.
 - The display can indicate temperatures 10% beyond each of the set ranges.

Thermistor Type

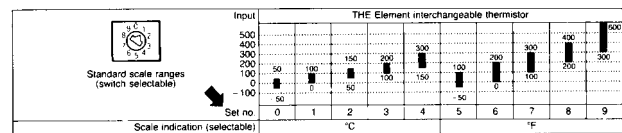

- Note:**
- The temperature range selector switch is factory-set to “0.” With a temperature range, such as 50° to 150°C, that exceeds the setting range, the indication unit is automatically adjusted to the minimum value. The set temperature is displayed when power is turned ON.
 - The temperature range that can actually be indicated for a set temperature range of -50° to 50°C is -50° to 60°C. For other temperature range settings it is the full scale ±10%.

Temperature Indication Switching Key

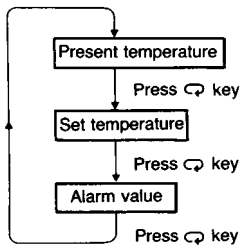

If the set temperature is shifted outside the temperature range as a result of changing the range, the set temperature is displayed. It is then automatically changed to the maximum or minimum value of the newly set range.

If the alarm value is shifted outside the temperature range as a result of changing the range, it is automatically changed to the maximum value of the newly set range.

If the alarm mode selector switch is set to "0" or "9", no alarm value is displayed.

On models without alarms, no alarm value is displayed.

DIP Switch Settings

The control mode and other settings are selected using the internal DIP switch as shown below.

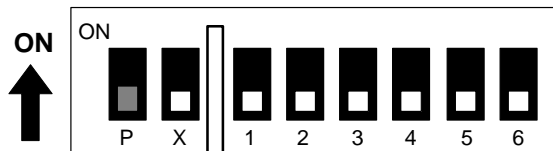

Function		P	X	1	2	3	4	5	6
Protect	ON								
	OFF								
---			Not used						
Control mode	PID			ON					
	ON/OFF			OFF					
Proportional period	2 s				ON				
	20 s				OFF				
Control output	Normal					ON			
	Reverse					OFF			
Input shift	Setting enabled						ON		
	Setting disabled						OFF		
Temperature sensor standard	DIN							ON	
	JIS							OFF	
Scale indicator (selectable)	°F							ON	
	°C							OFF	

Setting the Alarm Mode

The desired alarm mode can be chosen from one of the eight alarm modes using the alarm mode selector switch as shown below.

Switch setting	Mode	Alarm output
0, 9	No alarm function	OFF
1	Upper- and lower-limit alarms	
2	Upper-limit alarm	
3	Lower-limit alarm	
4	Upper- and lower-limit range alarm	
5	Upper- and lower-limit alarms with standby sequence (see note)	
6	Upper-limit alarm with standby sequence (see note)	
7	Lower-limit alarm with standby sequence (see note)	
8	Absolute-value alarm	

Note: The selector switch is factory-set to "2."
 The triangular mark ▲ indicates the set temperature.
 X denotes alarm values.
 Y denotes the set value value within the temperature range.

Operation of Standby Sequence

Alarm output set with standby sequence will operate in the way shown below when the temperature rises above the upper-limit.

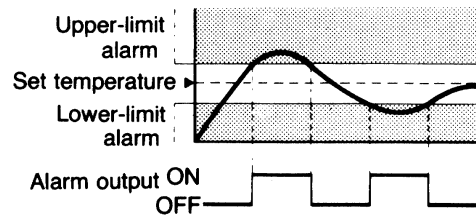

Alarm output set with standby sequence will operate in the way shown below when the temperature drops below the upper-limit.

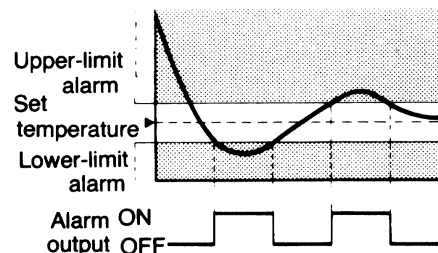

Control Mode Selection

ON/OFF Control

Pin 1 of the internal DIP switch is factory-set to OFF, so the Temperature Controller performs ON/OFF control.

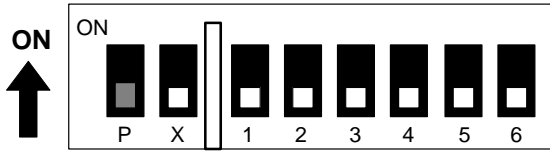

Pin 1 OFF: Temperature Controller performs ON/OFF.



Set pin 3 to ON when the Temperature Controller is used to control a cooling device, such as a freezer.

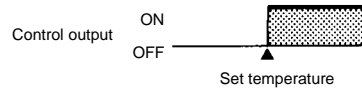
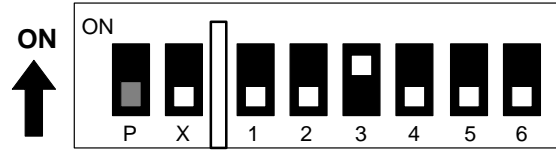

PID Control

Set pin 1 of the internal DIP switch to ON to make the Temperature Controller perform PID control. Follow the steps described below.

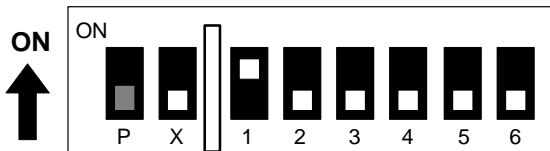

Pin 1 ON: Temperature Controller performs PID control.

Determining Control Output Operation

If the Temperature Controller is used to control a heater, the control output can be set to perform reverse (inverted) operation. Set pin 3 of the control output mode selector switch to OFF.

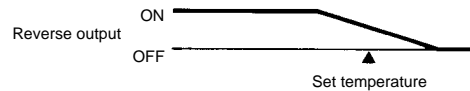
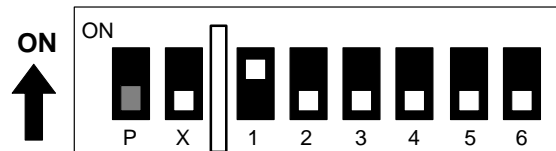

Determining Proportional Period

Set pin 2 of the DIP switch to OFF to select a proportional period of 20 seconds. This is used when PID control is performed with the relay output of the Temperature Controller, or when using an external relay or contactor.

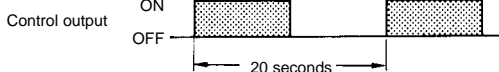
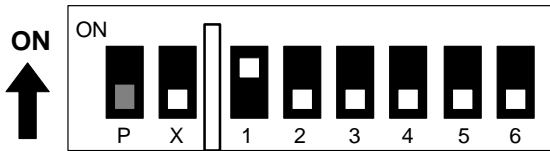

When a quick response is required, set pin 2 to ON to select a proportional period of 2 seconds. Even when a solid-state relay (SSR) is used, only set the 2-second proportional period where quick response is essential. With a relay control output, a proportional period of 2 seconds will greatly reduce the service life of the relay.

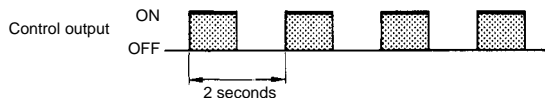
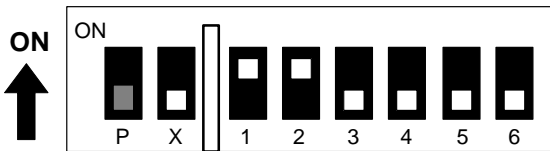

Conversely, if the Temperature Controller is used to control a cooling device such as a freezer, set pin 3 to ON.

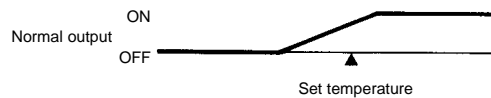
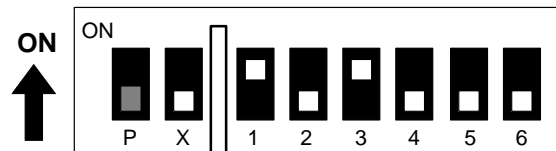

When power is first turned ON, the proportional band is set to 3%. The optimum proportional band, however, is automatically calculated and set within the range 3% to 20%, according to the changes in the temperature of the controlled system. This automatic adjustment of the proportional band is possible regardless of whether the controlled system is a heating or cooling system.

When the power is turned OFF once, and then ON again, the control starts with the previous proportional band. A new proportional band, however, is automatically calculated and set.

The calculation of the proportional band is not carried out, however, if the temperature of the controlled system changes at a rate faster than 7.5% of the full scale per 2 seconds (e.g., faster than 3.75°C per second with a full scale of 100°C). In this case, the previously calculated and set proportional band is used.

The Temperature Controller is provided with an overshoot prevention function that suppresses the second overshoot and those that follow to a level less than the initial overshoot.

Input Shift Function

This function is used to shift the value displayed in the main display from the value actual measured by a desired amount. This powerful feature can be used for "fine tuning" compensation, while leaving the set temperature unaffected.

The input shift function is activated by setting pin 4 of the internal DIP switch to ON.

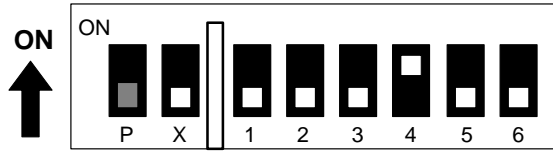

This allows the setting of the temperature shift value. Press the temperature indication switching (↻) key repeatedly until "H 0" (in this case, indicating a zero input shift) is displayed on the main display. Then set the input shift value by using the upward and downward setting keys.

Example

Main display	Temperature measured by sensor	Temperature displayed
H 0 (without shift)	100°C	100°C
H 9 (offset by +9°C)	100°C	109°C
L 16 (offset by -16°C)	100°C	84°C

The input shift value can be set within a range of -99 to 99, except with a 0.0 to 99.9 platinum resistance thermometer, where the input shift narrows to a range of -9.9 to 9.9.

When the desired shift has been entered, set pin 4 to OFF. The input shift value remains in memory. Consequently, if the input shift function is not needed, with pin 4 activated set the input shift value to 0.

Sensor Failure Operation Thermocouple Type

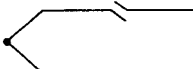
Condition	Display	Control output
Break in sensor 	FFF blinks	OFF

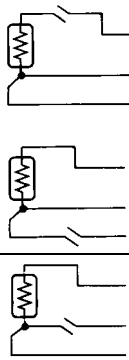
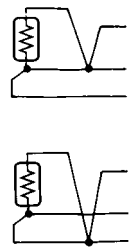

Note: When the input is short-circuited, the room temperature is displayed.

Platinum Resistance Thermometer Type

Condition	Display	Control output
Break in sensor 	FFF blinks	OFF
	--- blinks	OFF
	Disconnection of two or three wires FFF blinks	OFF
Short-circuit 	--- blinks	OFF

Note: The resistance of the platinum resistance thermometer is 100 Ω at 0°C. It increases to about 140 Ω at 100°C.

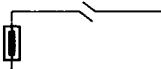
Thermistor Type

Condition	Display	Control output
Break in sensor 	---	ON during heating (reverse) OFF during cooling (normal)
Short-circuit 	FFF	ON during heating (reverse) OFF during cooling (normal)

Error Messages

The Temperature Controller is provided with self-diagnostic functions, and will display the following error messages if an error occurs.

Message	Cause	Control output
FFF	(1) Temperature has risen above set temperature range. (2) Thermistor has been short-circuited.	OFF during heating (reverse) ON during cooling (normal)
---	(1) Temperature has fallen below set temperature range. (2) Thermistor has broken.	ON during heating (reverse) OFF during cooling (normal)
FFF (blinks) (see note 1)	(1) Failure has occurred in thermocouple or platinum resistance thermometer. (2) Temperature has risen to a value much greater than the set temperature range.	OFF
--- (blinks) (see note 1)	(1) Failure has occurred in platinum resistance thermometer. (2) Polarities (positive and negative) of thermocouple have been reversed. (3) Temperature has fallen to a value much smaller than the set temperature range.	OFF
E11 or E33 (see note 1)	Memory failure (E11) or A/D converter failure (E33) has occurred. Temperature Controller must be repaired if normal operation is not restored by turning power OFF once and ON again.	Both control output and alarm output are OFF.

Note: 1. The key operations are disabled.

2. The models with alarm output produce alarm output according to the alarm output setting when the message "FFF" is displayed (or blinks), indicating that the temperature has risen above the set temperature range. Similarly, the alarm output is produced when the message "---" is displayed (or blinks), indicating that the temperature has fallen below the set temperature range.

■ Connections

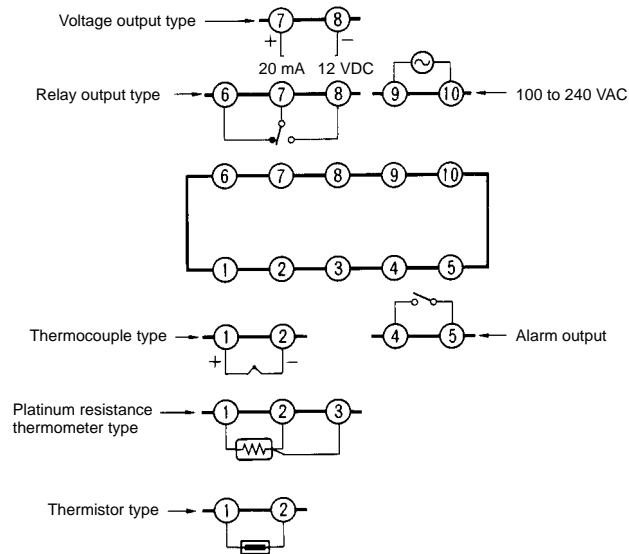

Dimensions

Note: All units are in millimeters unless otherwise indicated.

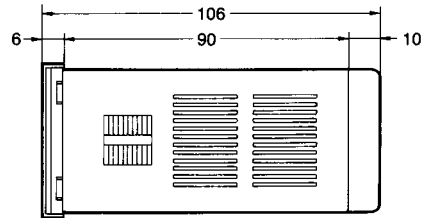
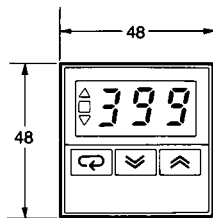

Panel cutout

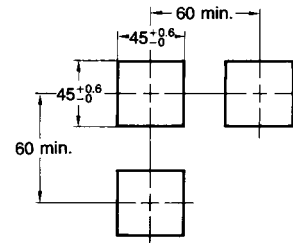

- Note:**
1. The recommended panel thickness is 1 to 4 mm.
 2. The Temperature Controller is contained in a mounting bracket, so close side-by-side Temperature Controller mounting is possible. Provide a center-to-center distance of at least 60 mm between two adjacent Temperature Controllers.

Precautions

Mounting

All Temperature Controllers in the E5CS-X Series conform to DIN43700 standard.

The recommended panel thickness is 1 to 4 mm.

Flush Mounting

Insert the Temperature Controller, back end first, into the hole of the mounting panel. Mount the adapter by pushing it forward from the back of the Temperature Controller. Push the adapter as close as possible to the front panel of the Temperature Controller to eliminate the gap between them. Then, secure the adapter with screws as shown in the figure below.

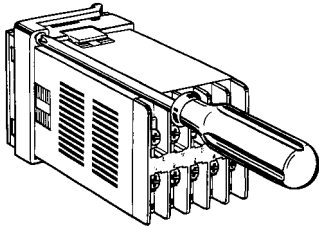

Removal

Loosen the screws on the adapter and push the hook open to remove the adapter.

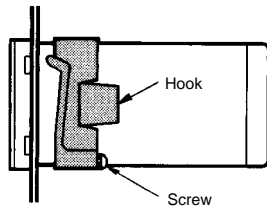

Environment

Do not install the Temperature Controller in locations subject to dust or corrosive gases. Do not install the Temperature Controller in locations subject to heavy vibrations or shocks, splashes of water or oil,

or high temperatures.

Separate the Temperature Controller from equipment that generates strong, high-frequency noise such as high-frequency welders.

Connection Examples

Solderless Terminal

Use M3.5 solderless terminals with the Temperature Controller's M3.5 self-rising pressure plate screws.

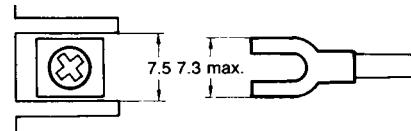

Solder-dipped Lead Wires

Strip the lead wire 6 to 12 mm and carefully arrange the wire tip.

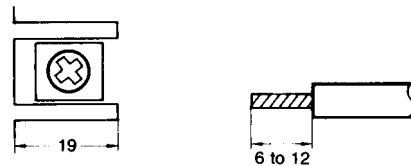

Do not tighten the terminal screw with excessive force.

Input Sensor Connection

The lead wires connecting the sensor to the Temperature Controller must be separated from power lines and load lines wherever possible, to prevent them from being induced by noise.

Use the specified compensating conductors for the thermocouple type Temperature Controllers.

Use lead wires with a small resistance for the Platinum resistance thermometer type Temperature Controllers.

Sequence Circuit

Several seconds are required until the relay is turned ON after power is supplied to the Temperature Controller. Therefore, take this time lag into consideration when designing a sequence circuit which incorporates the Temperature Controller.

ALL DIMENSIONS SHOWN ARE IN MILLIMETERS.

To convert millimeters into inches, multiply by 0.03937. To convert grams into ounces, multiply by 0.03527.

Cat. No. H032-E1-2A In the interest of product improvement, specifications are subject to change without notice.

OMRON Corporation

Industrial Automation Company

Measuring and Supervisory Controls Division
28th Fl., Crystal Tower Bldg.,
1-2-27, Shiromi, Chuo-ku,
Osaka 540-6028 Japan
Tel: (81)6-6949-6035/Fax: (81)6-6949-606

Printed in Japan
0300-0.3M (0689) A