



October 2007

FAN5665 High-Efficiency, Adaptive Charge Pump 5V Boost

Features

- 5V Fixed Output Voltage
- 30mA Maximum Output Current
- Built-in Charge Pump with Three Modes of Operation: 1×, 1.5×, and 2×
- Minimum External Components
- Flying Capacitors Only 0.22μF
- Low-noise, Constant-frequency Operation (1.2MHz) at Heavy Loads
- High-efficiency, Low-frequency Operation at Light Loads
- Low Quiescent Current
- Up to 92% Efficiency
- 2.9V to 5.5V Input Voltage Range
- Soft-start for Limiting Inrush Current
- Input Under-Voltage Lockout Protection (UVLO)
- Short-Circuit Protection (SCP)
- Thermal Shutdown Protection (TSD)
- 8-bump 1.21 x 1.21mm, 0.4mm Pitch WLCSP

Description

The FAN5665 is a 5V switched capacitor step-up DC/DC converter with an input voltage range from 2.9V to 5.5V. Switch reconfiguration and fractional switching techniques are utilized to achieve high efficiency over the entire input voltage range.

The FAN5665 includes built-in under-voltage lockout, short circuit, and thermal protection circuitry.

The FAN5665 is available in an 8-bump 0.4mm pitch WLCSP package.

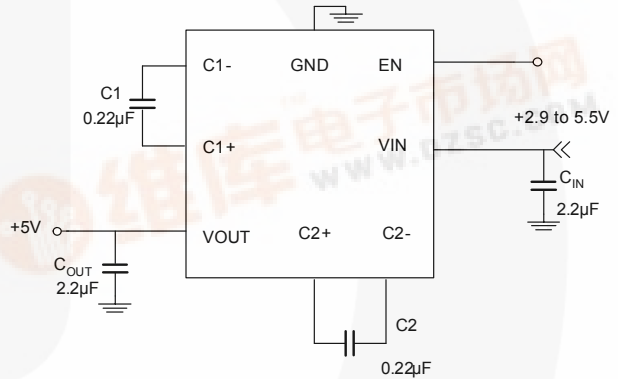

Figure 1. Typical Application

Applications

- USB I/O Supply Regulators
- Cell Phones, Smart-Phones
- Pocket PCs
- PDA, DSC, PMP, and MP3 Players

Ordering Information

Part Number	Operating Temperature Range	Package	Packing Method
FAN5665UCX	-40°C to +85°C	8-Lead Wafer-Level Chip-Scale Package (WLCSP), 1.21x1.21mm	Tape and Reel

All packages are lead free per JEDEC: J-STD-020B standard.

FAN5665 — High-Efficiency, Adaptive Charge Pump 5V Boost

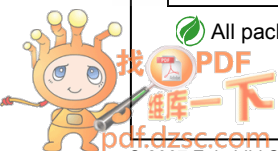

Pin Configuration

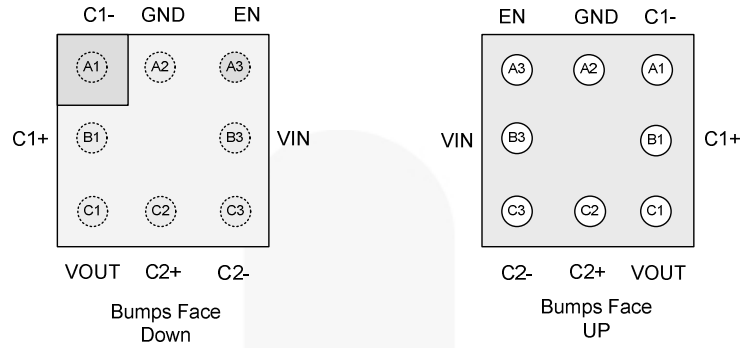

Figure 2. Pin Configuration

Pin Definitions

Pin #	Name	Description
A1	C1-	Bucket capacitor 1. Connect this pin to the negative terminal of the bucket (flying) capacitor.
A2	GND	Ground.
A3	EN	Enable. Enables the IC when high. Disables the IC when low and enters shutdown mode. No internal pull-up or pull-down; this pin should <i>not</i> be left floating.
B1	C1+	Bucket capacitor 1. Connect this pin to the positive terminal of the bucket (flying) capacitor.
B3	VIN	Power input.
C1	VOOUT	Regulated 5V output.
C2	C2+	Bucket capacitor 2. Connect this pin to the positive terminal of the bucket (flying) capacitor.
C3	C2-	Bucket capacitor 2. Connect this pin to the negative terminal of the bucket (flying) capacitor.

Absolute Maximum Ratings

Stresses exceeding the absolute maximum ratings may damage the device. The device may not function or be operable above the recommended operating conditions and stressing the parts to these levels is not recommended. In addition, extended exposure to stresses above the recommended operating conditions may affect device reliability. The absolute maximum ratings are stress ratings only.

Symbol	Parameter	Min.	Max.	Unit
V_{IN}	VIN Pin	-0.3	+6.0	V
	EN, VOUT, C1+, C1-, C2+, C2- Pins	-0.3	+6.0	V
T_J	Junction Temperature	-40	+150	°C
T_{STG}	Storage Temperature	-65	+150	°C
T_L	Lead Soldering Temperature, 10 Seconds		+260	°C
ESD	Human Body Model, JESD22-A114	3.5		kV
	Charged Device Model, JESD22-C101	2		

Recommended Operating Conditions

The Recommended Operating Conditions table defines the conditions for actual device operation. Recommended operating conditions are specified to ensure optimal performance to the datasheet specifications. Fairchild does not recommend exceeding them or designing to Absolute Maximum Ratings.

Symbol	Parameter	Min.	Typ.	Max.	Unit
V_{IN}	Power Supply Range	2.9		5.5	V
I_{OUT}	Output Current	0		30	mA
T_A	Operating Ambient Temperature Range	-40		+85	°C
T_J	Operating Junction Temperature Range	-40		+125	°C
C_{IN}, C_{OUT}	Input, output capacitor		2.2		μF
C1, C2	Bucket capacitor		0.22		μF

Thermal Properties

Symbol	Parameter	Min.	Typ.	Max.	Units
Θ_{JA}	Junction-to-Ambient Thermal Resistance		170 ⁽¹⁾		°C/W

Note:

1. Junction-to-ambient thermal resistance is a function of application and board layout. This data is measured with four-layer boards in accordance with JESD51- JEDEC standard. Special attention must be paid not to exceed maximum junction temperature (T_J) at a given ambient temperature (T_A).

Electrical Characteristics

Unless otherwise noted, $V_{IN} = 2.9V$ to $5.5V$, $C1 = C2 = 0.22\mu F$, $C_{IN} = 2.2\mu F$, $C_{OUT} = 2.2\mu F$, $T_A = -40^\circ C$ to $+85^\circ C$, and test circuit is Figure 1. Typical values are at $T_A = 25^\circ C$, $V_{IN} = 3.6V$.

Symbol	Parameter	Conditions	Min.	Typ.	Max.	Units
Power Supplies						
I_{SD}	Shutdown Current	$V_{IN} = 3.6V$		0.1	1.0	μA
I_{DD}	Quiescent Current	$V_{IN} = 3.6V, I_{OUT} = 0mA$		190	300	μA
		$V_{IN} = 5.5V, I_{OUT} = 0mA$		108	200	
V_{IH}	Enable High-level Input Voltage		1.1			V
V_{IL}	Enable Low-level Input Voltage				0.4	V
I_{IH}	Enable Pin Input Current	$EN = 1.8V$		0.01	1.00	μA
V_{HUVLO}	Under-voltage Lockout High Threshold	V_{IN} Rising	2.65		2.80	V
V_{LUVLO}	Under-voltage Lockout Low Threshold	V_{IN} Falling	2.35		2.60	V
	UVLO Hysteresis			250		mV
Regulation						
V_{OUT}	Voltage Accuracy		4.85	5.00	5.15	V
V_{OUT_RIPPLE}	Output Voltage Ripple	$V_{IN} = 3.6V, I_{OUT} = 2mA$		25		mV _{pp}
		$V_{IN} = 3.6V, I_{OUT} = 30mA$		15		
I_{SC}	Short-Circuit Current Limit	$V_{OUT} < 150mV$	45	55	80	mA
TSD	Thermal Shutdown	Rising Temperature		150		$^\circ C$
		Hysteresis		20		
Timing						
f_{OSC}	Internal Oscillator Frequency	$V_{IN} = 3.6V, I_{OUT} = 20mA$	0.9	1.2	1.5	MHz
		$V_{IN} = 3.6V, I_{OUT} = 2mA$	40	49	65	kHz
t_{SS}	Soft-start	$EN = 0$ to 1		570	950 ⁽²⁾	μs

Note:

- Guaranteed by design.

Typical Performance Characteristics

Unless otherwise noted, $C_{IN} = 2.2\mu\text{F}$, $C_{OUT} = 2.2\mu\text{F}$, $C_1 = C_2 = 0.22\mu\text{F}$, $T_A = 25^\circ\text{C}$.

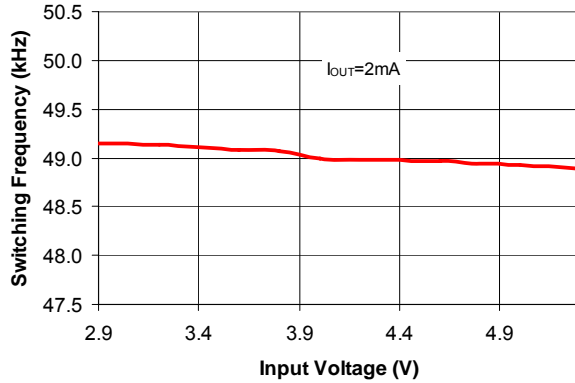

Figure 3. Light-Load Switching Frequency vs. Input Voltage

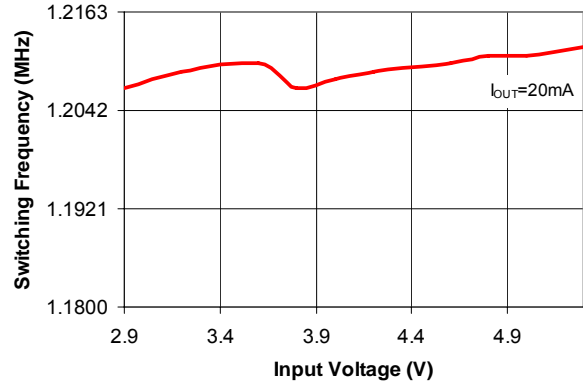

Figure 4. Heavy-Load Switching Frequency vs. Input Voltage

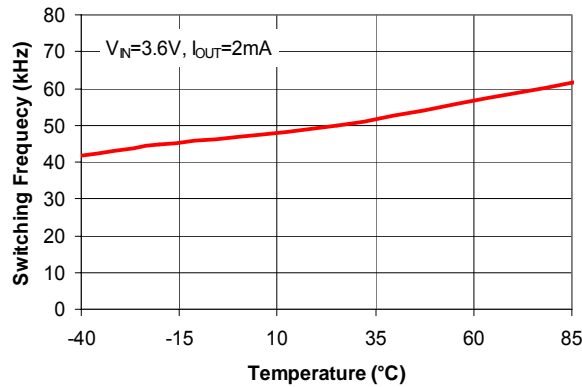

Figure 5. Light-Load Switching Frequency vs. Temperature

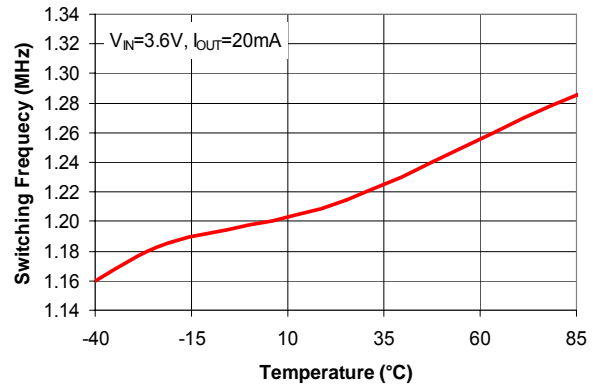

Figure 6. Heavy-Load Switching Frequency vs. Temperature

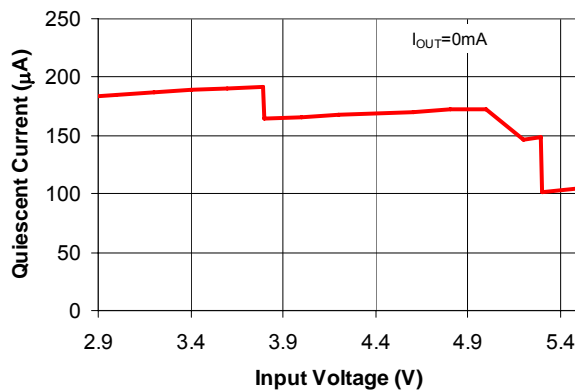

Figure 7. Quiescent Current vs. Input Voltage

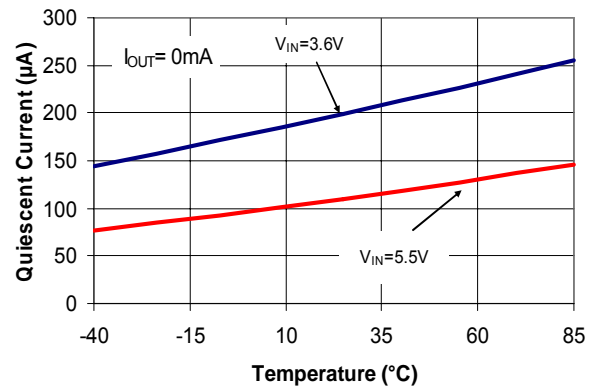

Figure 8. Quiescent Current vs. Temperature

Typical Performance Characteristics (Continued)

Unless otherwise noted, $C_{IN} = 2.2\mu\text{F}$, $C_{OUT} = 2.2\mu\text{F}$, $C_1 = C_2 = 0.22\mu\text{F}$, $T_A = 25^\circ\text{C}$.

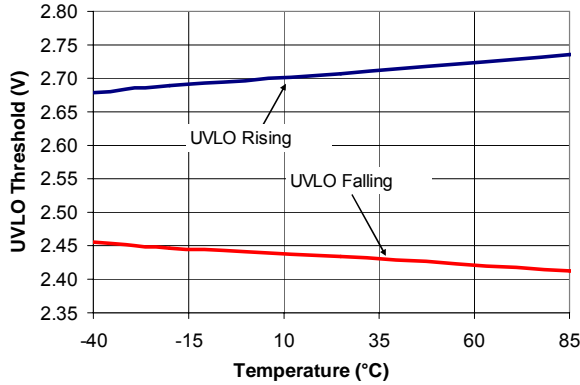

Figure 9. UVLO Threshold vs. Temperature

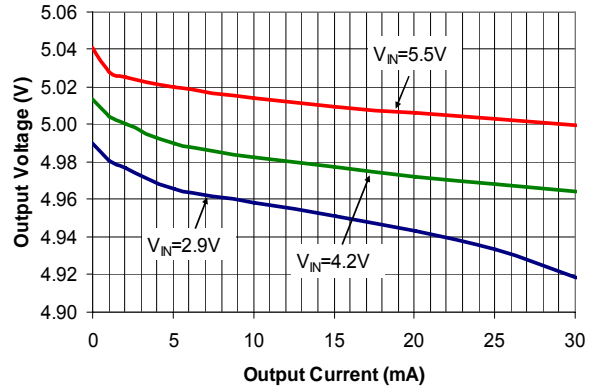

Figure 10. Load Regulation

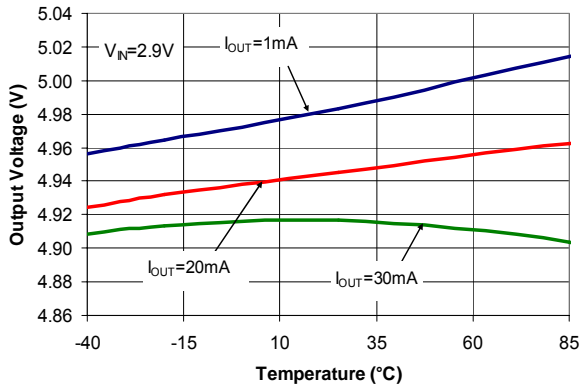

Figure 11. Output Voltage vs. Temperature

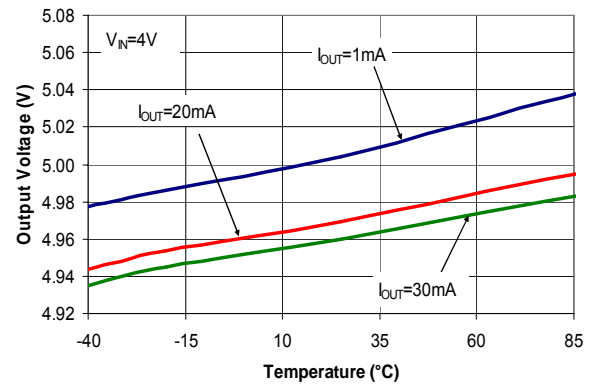

Figure 12. Output Voltage vs. Temperature

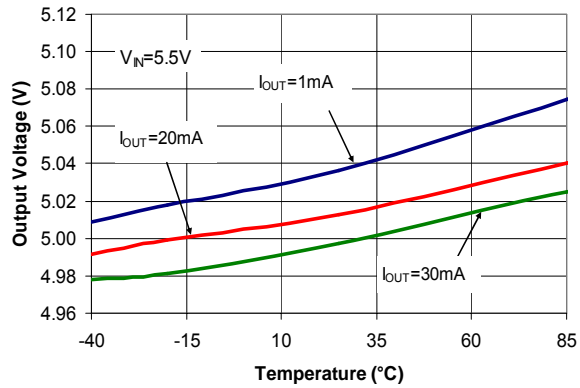

Figure 13. Output Voltage vs. Temperature

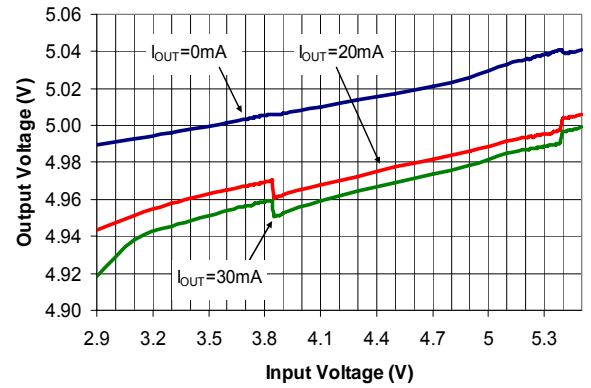

Figure 14. Line Regulation

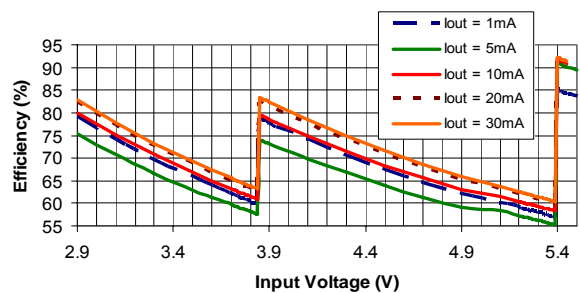

Figure 15. Efficiency vs. Input Voltage

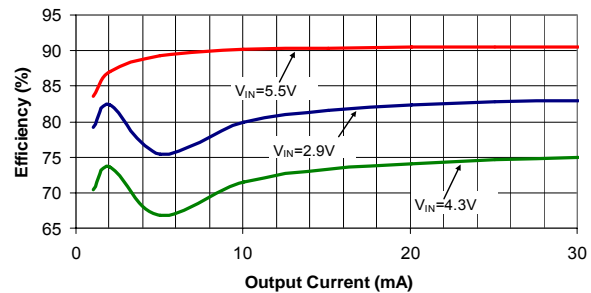

Figure 16. Efficiency vs. Output Current

Typical Performance Characteristics (Continued)

Unless otherwise noted, $C_{IN} = 2.2\mu\text{F}$, $C_{OUT} = 2.2\mu\text{F}$, $C_1 = C_2 = 0.22\mu\text{F}$, $T_A = 25^\circ\text{C}$.

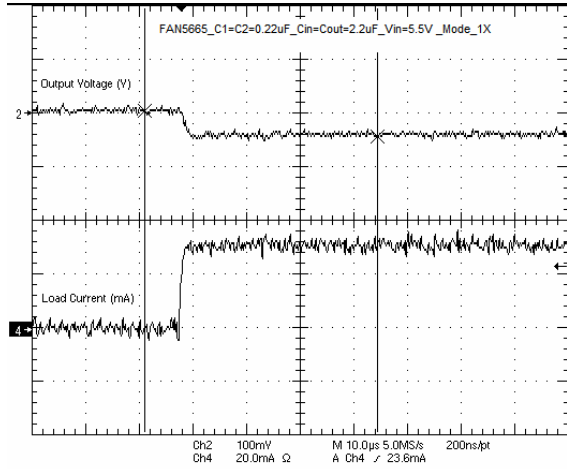

Figure 17. Load Transient from 0 to 30mA in 1x Mode

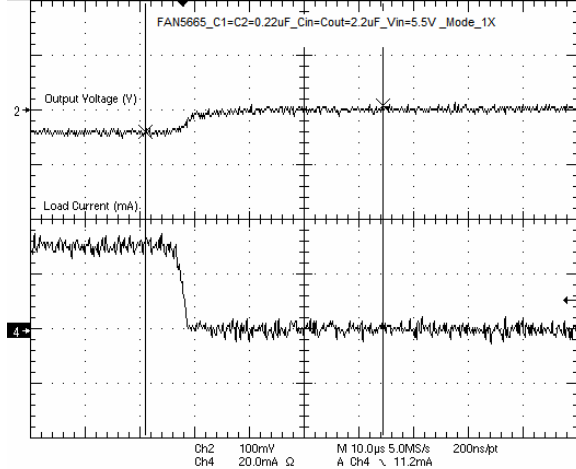

Figure 18. Load Transient from 30 to 0mA in 1x Mode

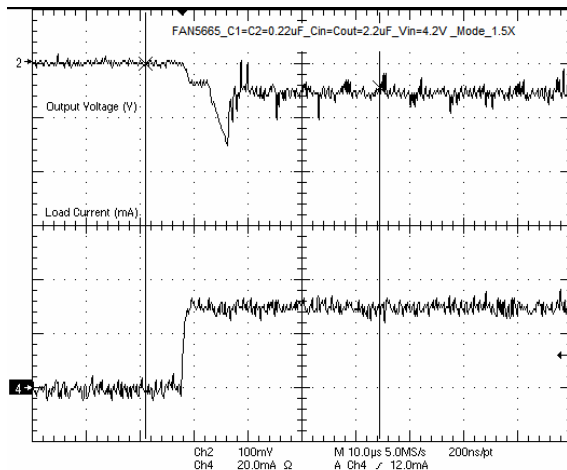

Figure 19. Load Transient from 0 to 30mA in 1.5x Mode

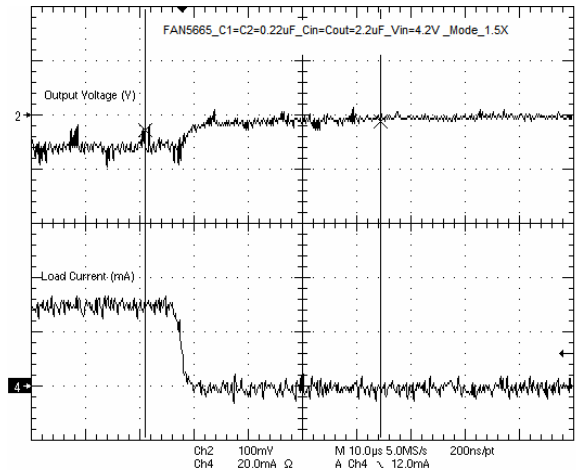

Figure 20. Load Transient from 30 to 0mA in 1.5x Mode

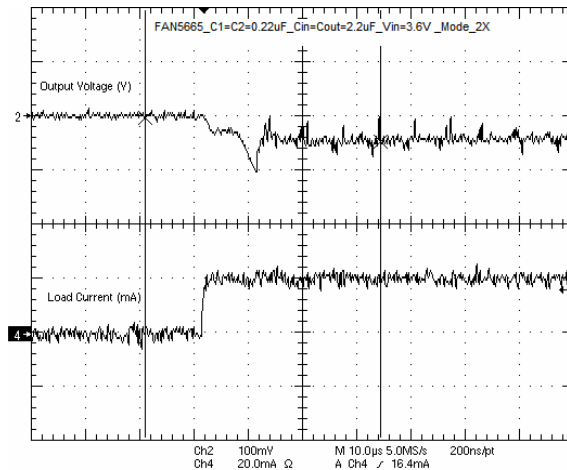

Figure 21. Load Transient from 0 to 20mA in 2x Mode

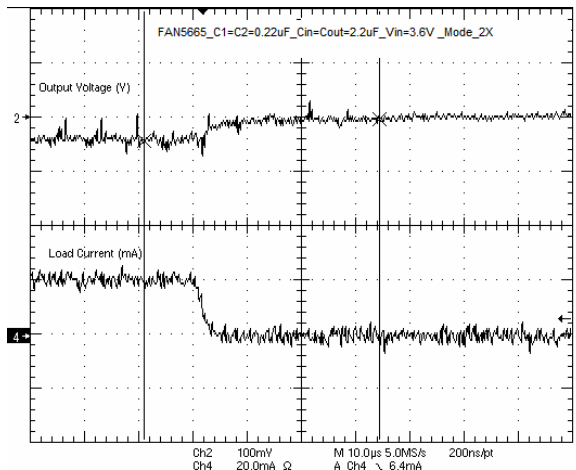

Figure 22. Load Transient from 20 to 0mA in 2x Mode

Typical Performance Characteristics (Continued)

Unless otherwise noted, $C_{IN} = 2.2\mu\text{F}$, $C_{OUT} = 2.2\mu\text{F}$, $C_1 = C_2 = 0.22\mu\text{F}$, $T_A = 25^\circ\text{C}$.

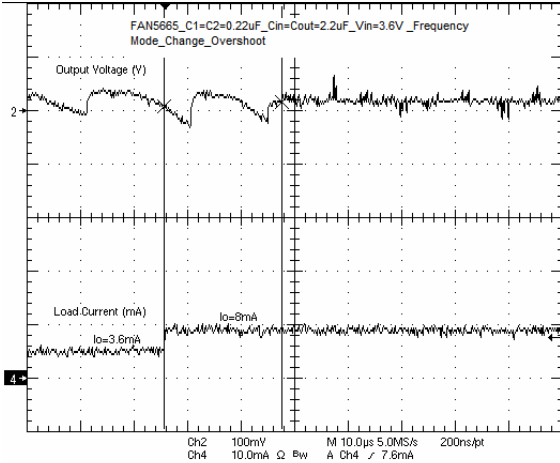

Figure 23. Load Transient from 4 to 8mA in 2x Mode

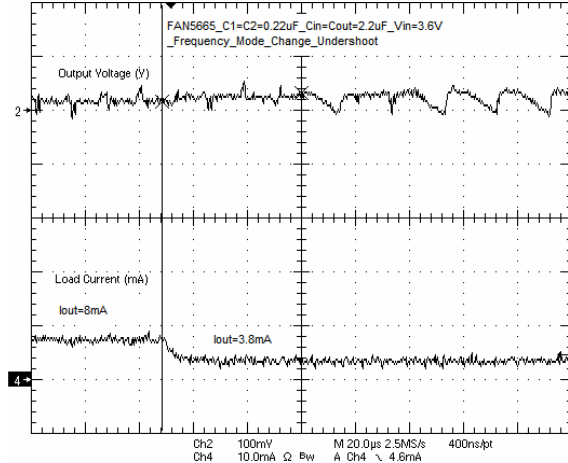

Figure 24. Load Transient from 8 to 4mA in 2x Mode

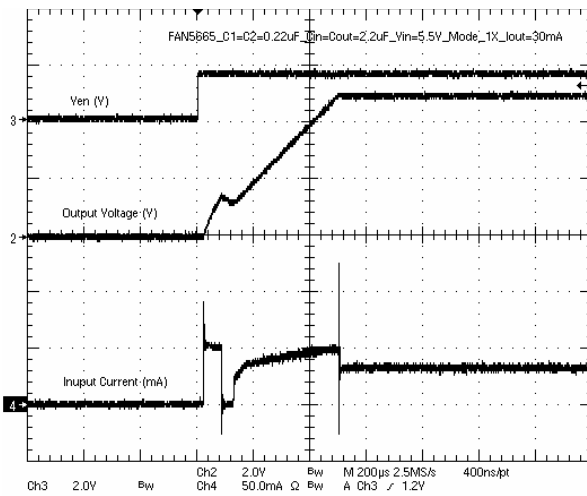

Figure 25. Start-up at $I_{OUT} = 30\text{mA}$ in 1x Mode

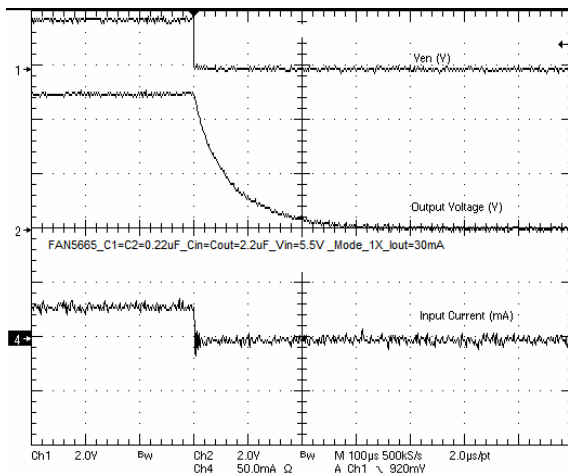

Figure 26. Turn-off at $I_{OUT} = 30\text{mA}$ in 1x Mode

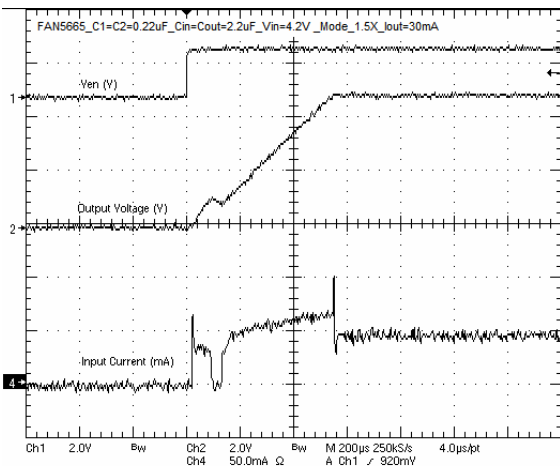

Figure 27. Start-up at $I_{OUT} = 30\text{mA}$ in 1.5x Mode

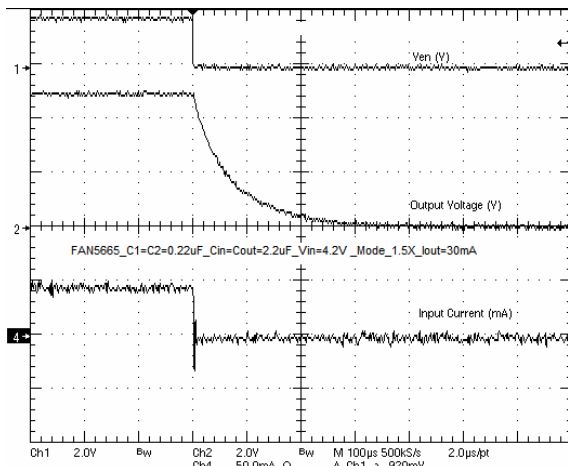

Figure 28. Turn-off at $I_{OUT} = 30\text{mA}$ in 1.5x Mode

Typical Performance Characteristics (Continued)

Unless otherwise noted, $C_{IN} = 2.2\mu\text{F}$, $C_{OUT} = 2.2\mu\text{F}$, $C_1 = C_2 = 0.22\mu\text{F}$, $T_A = 25^\circ\text{C}$.

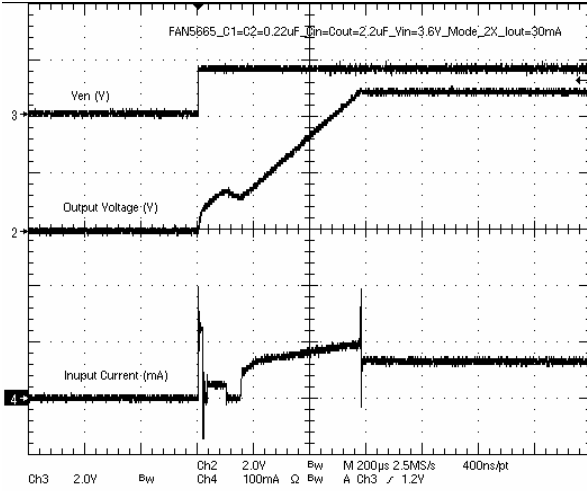

Figure 29. Start-up at $I_{OUT} = 30\text{mA}$ in 2x Mode

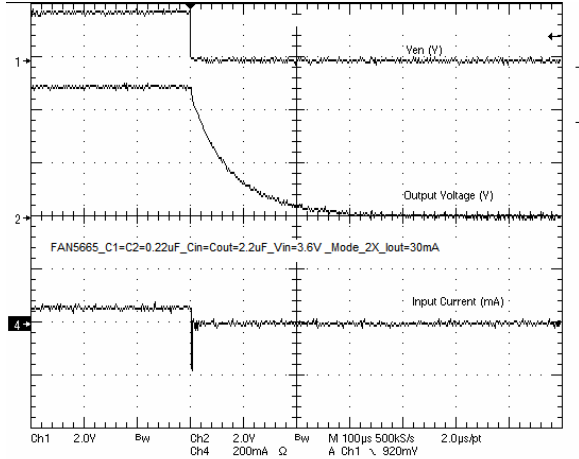

Figure 30. Turn-off at $I_{OUT} = 30\text{mA}$ in 2x Mode

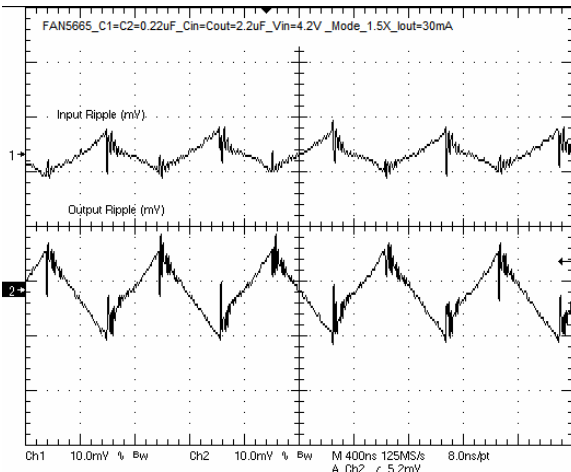

Figure 31. Input and Output Ripple at $I_{OUT} = 30\text{mA}$ in 1.5x Mode

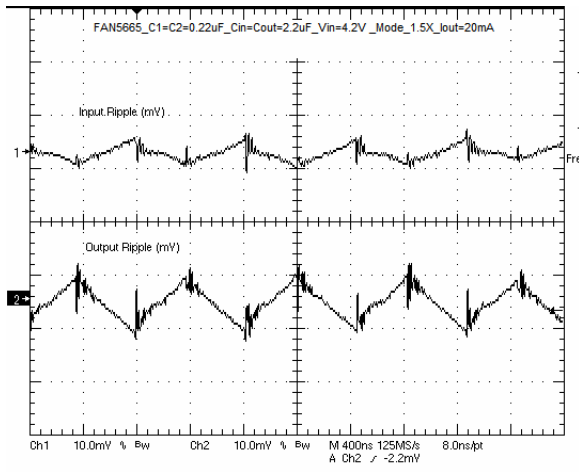

Figure 32. Input and Output Ripple at $I_{OUT} = 20\text{mA}$ in 1.5x Mode

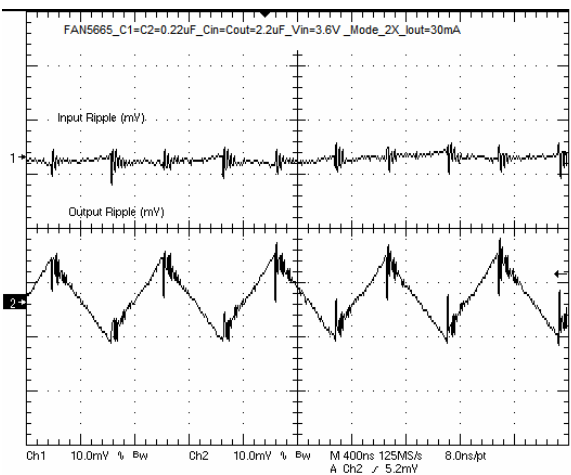

Figure 33. Input and Output Ripple at $I_{OUT} = 30\text{mA}$ in 2x Mode

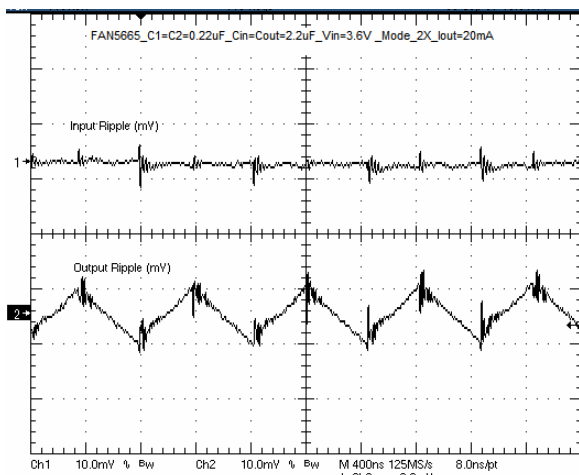

Figure 34. Input and Output Ripple at $I_{OUT} = 20\text{mA}$ in 2x Mode

Typical Performance Characteristics (Continued)

Unless otherwise noted, $C_{IN} = 2.2\mu\text{F}$, $C_{OUT} = 2.2\mu\text{F}$, $C_1 = C_2 = 0.22\mu\text{F}$, $T_A = 25^\circ\text{C}$.

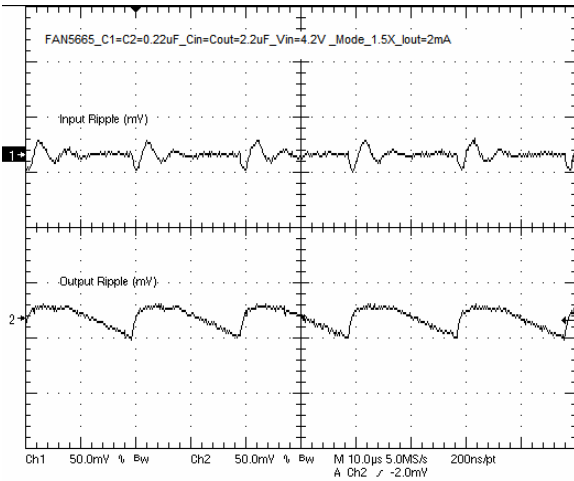

Figure 35. Input and Output Ripple at $I_{OUT} = 2\text{mA}$ in 1.5x Mode

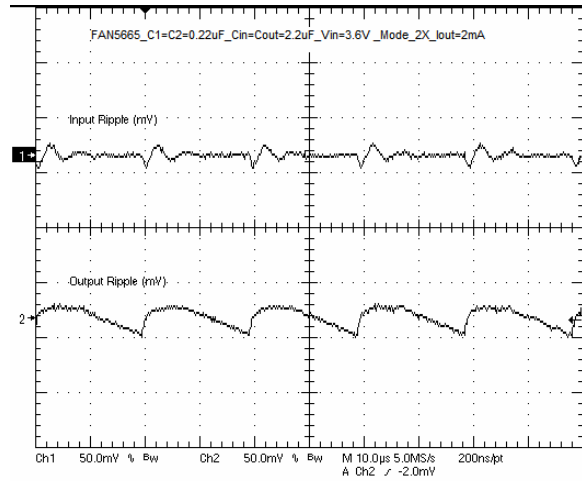

Figure 36. Input and Output Ripple at $I_{OUT} = 2\text{mA}$ in 2x Mode

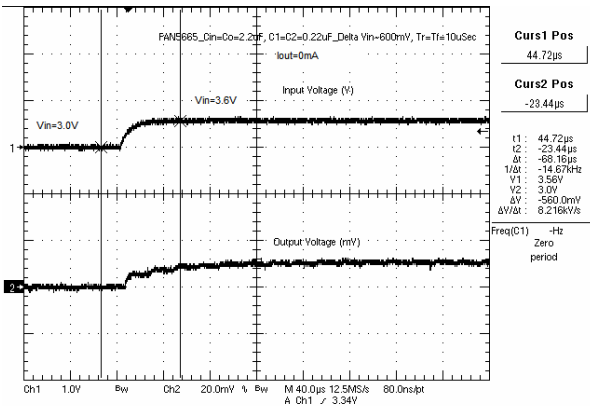

Figure 37. Line Transient 600mV Rising

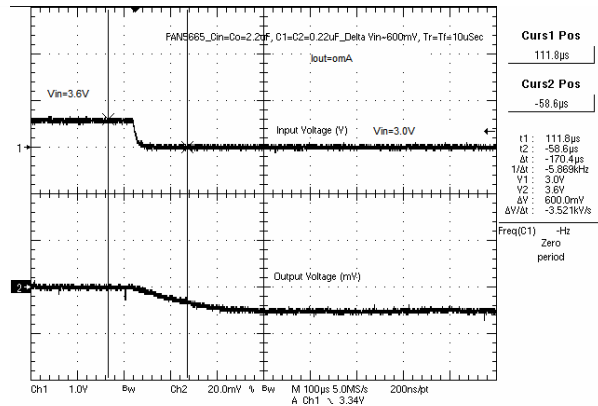

Figure 38. Line Transient 600mV Falling

Block Diagram

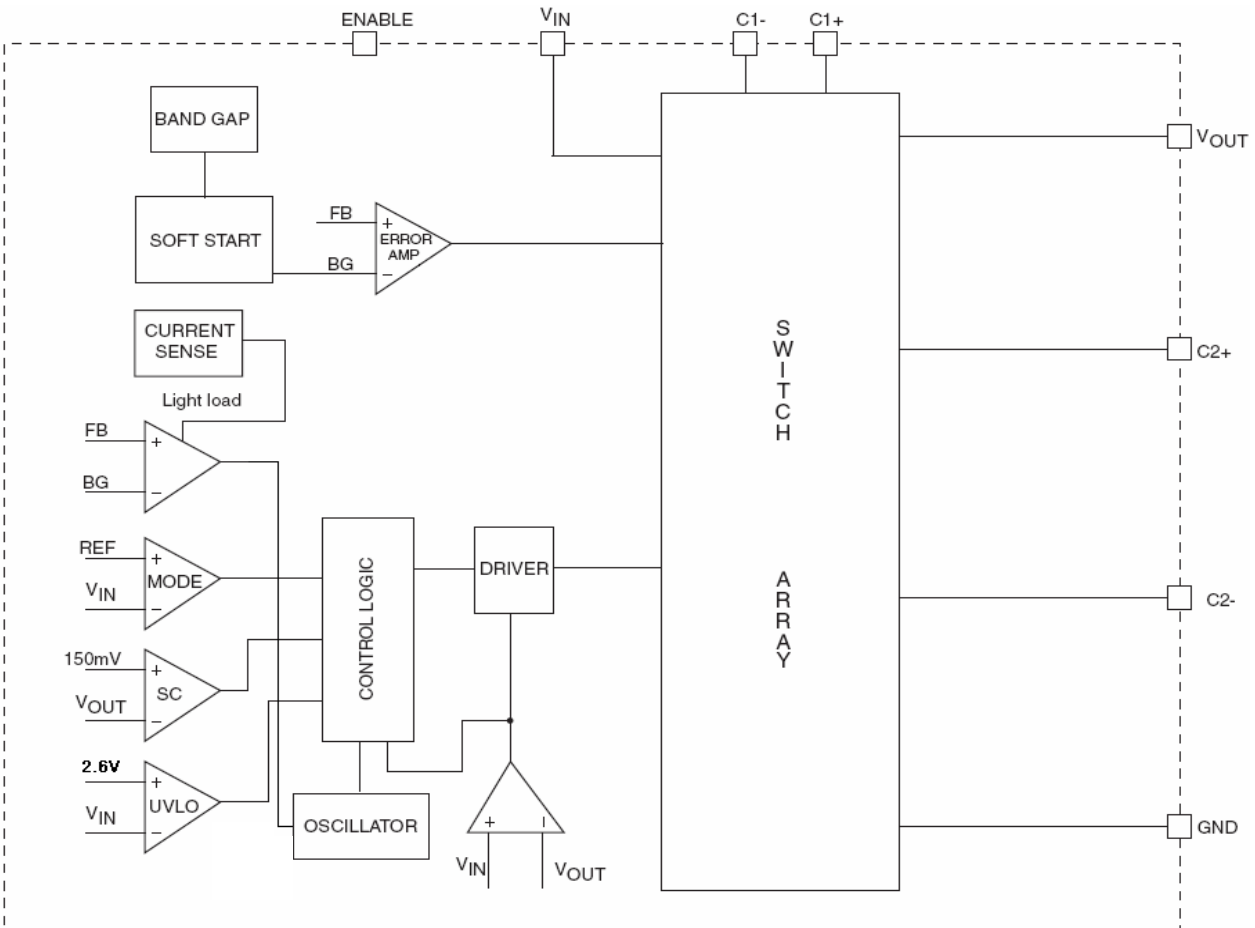

Figure 39. Block Diagram

Functional Description

Overview

FAN5665 is a 5V switched capacitor regulator with very low output ripple and high efficiency. The maximum output current is 30mA.

Linear Regulation Loop

The linear regulation loop (consisting of the power transistors, output feedback, and error amplifier), is used to regulate the output voltage and reduce current spikes at mode change.

Soft-start

At power-up, the device has 0.5ms soft-start to control the inrush current and make the output ramp up slowly.

Modes of Operation

FAN5665 has 1x, 1.5x, and 2x modes. Input voltage is compared with reference to determine mode.

Light / Heavy Load Monitor

In 1.5x / 2x mode, there is a current sense to detect the output current. If a light-load condition is detected, the device switches to a lower switching frequency around 50kHz. This frequency is a good compromise between achieving high light-load efficiency and not causing audible noise generation. If the load is heavy (typically more than 5mA), the device switches at 1.2MHz to decrease the output voltage ripple.

Protection

FAN5665 has thermal shutdown protection when the die temperature is more than 150°C. It turns back off when the temperature falls by about 10°C.

Short-circuit protection helps avoid damage to the device when the output is shorted to ground. Whenever output voltage is pulled below 150mV, short-circuit protection is triggered and limits the input current. If $V_{OUT} > 150mV$, protection is in the form of thermal shutdown if die temperature exceeds 150°C.

Applications Information

The high switching frequency of 1.2MHz allows the use of small capacitors, but the material of the capacitor affects the input and output ripple, so the low-ESR capacitors are desirable. Another parameter affected by ESR is the efficiency. For proper operation, two ceramic bucket capacitors, along with one ceramic input capacitor and one ceramic output capacitor, are recommended (as shown in Figure 1).

Input Capacitor Selection

In general, the ripple on the input power rail also affects the output ripple. The lower the ESR of the input capacitor, the lower the input and output ripple. The input capacitor may need to be adjusted, both in its value and in its physical placement on the PCB, depending upon the characteristics of the voltage source providing the input power. In general, a 1 to 2 μ F ceramic capacitor placed close to the FAN5665 suffices. X5R and X7R capacitors provide adequate performance over -40°C to +85°C. The following table represents typical recommended input capacitors.

Description	Part Number	Vendor
Capacitor 2.2 μ F, 10%, 6.3V, X5R, 0603	GRM188R60J225KE19D	Murata
Capacitor 2.2 μ F, 20%, 6.3V, X5R, 0402	GRM155R60J225ME15D	Murata

Output Capacitor Selection

In general, multilayer ceramic capacitors are recommended for low ESR. The value of the output bulk capacitance in relation to the switching frequency of the converter also determines the overall output voltage ripple. A higher value of output capacitance reduces the voltage droop during load transients. Typically, the output capacitor can be 5 to 50 times larger than the bucket capacitor(s), depending on the desired output ripple tolerance. Both X5R- and X7R-rated capacitors provide adequate performance over a -40°C to +85°C temperature range. The following table contains typical recommended output capacitors.

Description	Part Number	Vendor
Capacitor 2.2 μ F, 10%, 6.3V, X5R, 0603	GRM188R60J225KE19D	Murata
Capacitor 2.2 μ F, 20%, 6.3V, X5R, 0402	GRM155R60J225ME15D	Murata

Bucket Capacitor Selection

The bucket (flying) capacitor is usually the smallest capacitor in a charge pump circuit, but its ESR can play a significant role in determining the output voltage tolerance. Only ceramic capacitors are recommended in this position. The flying capacitance is determined by the switching frequency. At 1.2MHz, 0.22 μ F flying capacitors are suitable for most applications, but can be increased to improve the output tolerance. Depending on the material of the multilayer ceramic capacitor, a substantial amount of capacitance may be lost over a wide temperature range. At least X5R and X7R capacitors are recommended for their relatively stable temperature characteristics. Z5U- or Y5V-type capacitors are not recommended. The following table shows a typical recommended bucket capacitor.

Description	Part Number	Vendor
Capacitor 0.22 μ F, 10%, 6.3V, X5R, 0402	GRM155R60J224KE01D	Murata

Increasing Output Current Capability

Two parallel FAN5665s increase the output current. In such a configuration, the VIN, VOUT, GND, and EN pins of each IC should be connected together, but the respective C1 and C2 pins must be kept separate. Separate local input and output bypassing / decoupling may be required to reduce output noise and ripple.

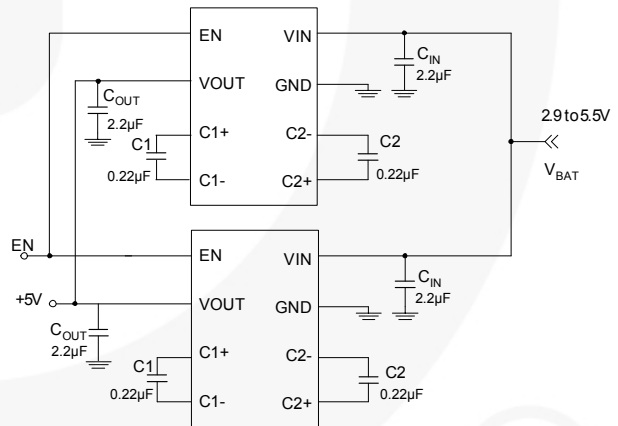

Figure 40. Two FAN5665s in Parallel

Applications Information (Continued)

LED Driver

The FAN5665 can be configured as an LED driver, as shown in Figure 41. The constant current is generated by putting a resistor in series with the LED. The value of series resistor is dictated by the current through the LED. The maximum current that the FAN5665 can deliver is 30mA. The number of parallel branches and current through LEDs should be chosen according to the maximum output current.

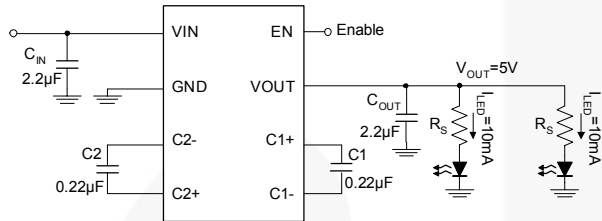

Figure 41. LED Driver Example Circuit

PCB Layout

The PCB layout should be designed carefully due to the high switching frequency and corresponding transient currents. All the external capacitors should be connected very close to the pins of the IC. A clean board layout with a good ground plane ensures proper operation of the device. A PCB recommendation for a two-layer board is shown in Figure 42. Note that the bottom layer is a dedicated ground plane.

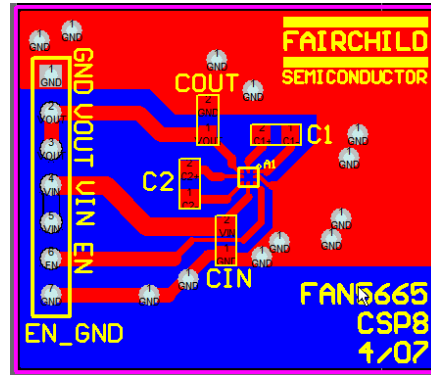
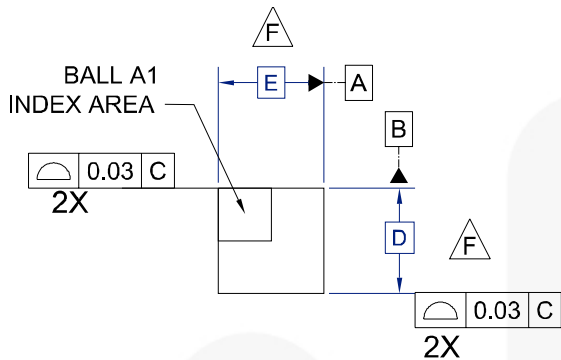
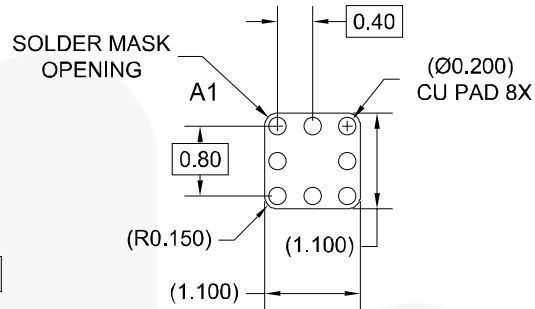

Figure 42. PCB Layout

Physical Dimensions



TOP VIEW



RECOMMENDED LAND PATTERN

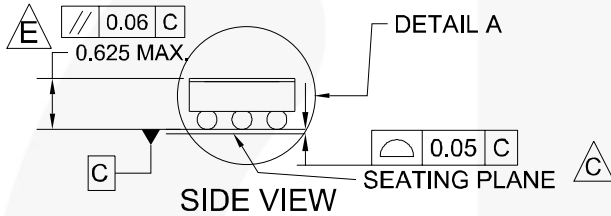

SIDE VIEW

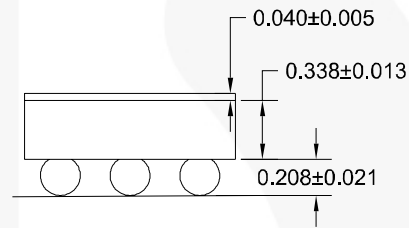

DETAIL A

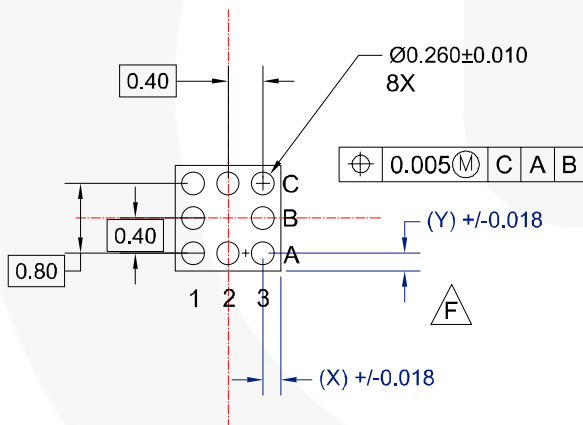

BOTTOM VIEW

NOTES:

- A. NO JEDEC REGISTRATION APPLIES
- B. DIMENSIONS AND TOLERANCES PER ASME Y14.5M, 1994
- C. DATUM C, THE SEATING PLANE, IS DEFINED BY THE SPHERICAL CROWN OF THE BALLS.
- D. BALL COMPOSITION: Sn95.5Ag3.9Cu0.6 SAC405 ALLOY
- E. PACKAGE HEIGHT IS 586 MICRONS +/- 39 MICRONS (625 - 547 MICRONS)
- F. FOR DIMENSIONS D, E, X, AND Y SEE PRODUCT DATASHEET.
- G. DIMENSIONS ARE IN MILLIMETERS
- H. DRAWING FILENAME: MKT-UC008ACrev1

MKT-UC008ACrev1

Product	D	E	X	Y
FAN5665UC5X	1.210 +/- 0.030mm	1.210 +/- 0.030mm	0.205mm	0.205mm

Figure 43. 8-Lead Wafer-Level Chip-Scale Package (WLCSP), 1.21x1.21mm



TRADEMARKS

The following are registered and unregistered trademarks and service marks Fairchild Semiconductor owns or is authorized to use and is not intended to be an exhaustive list of all such trademarks.

ACE [®]	Green FPS [™]	Power247 [®]	SuperSOT [™] -8
Build it Now [™]	Green FPS [™] e-Series [™]	POWEREDGE [®]	SyncFET [™]
CorePLUS [™]	GTO [™]	Power-SPM [™]	The Power Franchise [®]
CROSSVOLT [™]	<i>i-Lo</i> [™]	PowerTrench [®]	the power
CTL [™]	IntelliMAX [™]	Programmable Active Droop [™]	franchise
Current Transfer Logic [™]	ISOPLANAR [™]	QFET [®]	TinyBoost [™]
EcoSPARK [®]	MegaBuck [™]	QS [™]	TinyBuck [™]
F [®]	MICROCOUPLER [™]	QT Optoelectronics [™]	TinyLogic [®]
Fairchild [®]	MicroFET [™]	Quiet Series [™]	TINYOPTO [™]
Fairchild Semiconductor [®]	MicroPak [™]	RapidConfigure [™]	TinyPower [™]
FACT Quiet Series [™]	MillerDrive [™]	SMART START [™]	TinyPWM [™]
FACT [®]	Motion-SPM [™]	SPM [®]	TinyWire [™]
FAST [®]	OPTOLOGIC [®]	STEALTH [™]	μSerDes [™]
FastvCore [™]	OPTOPLANAR [®]	SuperFET [™]	UHC [®]
FPS [™]	[®]	SuperSOT [™] -3	UniFET [™]
FRFET [®]	PDP-SPM [™]	SuperSOT [™] -6	VCX [™]
Global Power Resource SM	Power220 [®]		

DISCLAIMER

FAIRCHILD SEMICONDUCTOR RESERVES THE RIGHT TO MAKE CHANGES WITHOUT FURTHER NOTICE TO ANY PRODUCTS HEREIN TO IMPROVE RELIABILITY, FUNCTION, OR DESIGN. FAIRCHILD DOES NOT ASSUME ANY LIABILITY ARISING OUT OF THE APPLICATION OR USE OF ANY PRODUCT OR CIRCUIT DESCRIBED HEREIN; NEITHER DOES IT CONVEY ANY LICENSE UNDER ITS PATENT RIGHTS, NOR THE RIGHTS OF OTHERS. THESE SPECIFICATIONS DO NOT EXPAND THE TERMS OF FAIRCHILD'S WORLDWIDE TERMS AND CONDITIONS, SPECIFICALLY THE WARRANTY THEREIN, WHICH COVERS THESE PRODUCTS.

LIFE SUPPORT POLICY

FAIRCHILD'S PRODUCTS ARE NOT AUTHORIZED FOR USE AS CRITICAL COMPONENTS IN LIFE SUPPORT DEVICES OR SYSTEMS WITHOUT THE EXPRESS WRITTEN APPROVAL OF FAIRCHILD SEMICONDUCTOR CORPORATION.

As used herein:

1. Life support devices or systems are devices or systems which, (a) are intended for surgical implant into the body or (b) support or sustain life, and (c) whose failure to perform when properly used in accordance with instructions for use provided in the labeling, can be reasonably expected to result in a significant injury of the user.
2. A critical component in any component of a life support, device, or system whose failure to perform can be reasonably expected to cause the failure of the life support device or system, or to affect its safety or effectiveness.

PRODUCT STATUS DEFINITIONS

Definition of Terms

Datasheet Identification	Product Status	Definition
Advance Information	Formative or In Design	This datasheet contains the design specifications for product development. Specifications may change in any manner without notice.
Preliminary	First Production	This datasheet contains preliminary data; supplementary data will be published at a later date. Fairchild Semiconductor reserves the right to make changes at any time without notice to improve design.
No Identification Needed	Full Production	This datasheet contains final specifications. Fairchild Semiconductor reserves the right to make changes at any time without notice to improve design.
Obsolete	Not In Production	This datasheet contains specifications on a product that has been discontinued by Fairchild Semiconductor. The datasheet is printed for reference information only.