



April 2008

FGH80N60FD2

600V, 80A Field Stop IGBT

Features

- High current capability
- Low saturation voltage: $V_{CE(sat)} = 1.8V @ I_C = 40A$
- High input impedance
- Fast switching
- RoHS compliant

Applications

- Induction Heating Application



General Description

Using Novel Field Stop IGBT Technology, Fairchild's new series of Field Stop IGBTs offer the optimum performance for Induction Heating applications where low conduction and switching losses are essential.

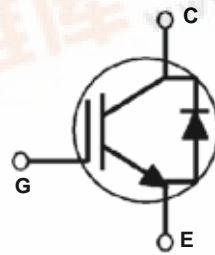
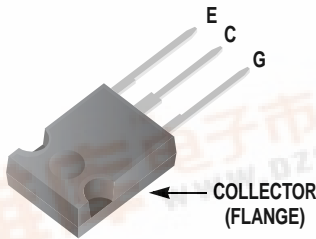

Absolute Maximum Ratings

Symbol	Description	Ratings	Units
V_{CES}	Collector-Emitter Voltage	600	V
V_{GES}	Gate-Emitter Voltage	± 20	V
I_C	Collector Current @ $T_C = 25^\circ C$	80	A
	Collector Current @ $T_C = 100^\circ C$	40	A
$I_{CM(1)}$	Pulsed Collector Current @ $T_C = 25^\circ C$	160	A
P_D	Maximum Power Dissipation @ $T_C = 25^\circ C$	290	W
	Maximum Power Dissipation @ $T_C = 100^\circ C$	116	W
T_J	Operating Junction Temperature	-55 to +150	$^\circ C$
T_{stg}	Storage Temperature Range	-55 to +150	$^\circ C$
T_L	Maximum Lead Temp. for soldering Purposes, 1/8" from case for 5 seconds	300	$^\circ C$

Notes :

(1) Repetitive rating : Pulse width limited by max. junction temperature

Thermal Characteristics

Symbol	Parameter	Typ.	Max.	Units
$R_{\theta JC}(IGBT)$	Thermal Resistance, Junction-to-Case	--	0.43	$^\circ C/W$
$R_{\theta JC}(Diode)$	Thermal Resistance, Junction-to-Case	--	1.45	$^\circ C/W$
$R_{\theta JA}$	Thermal Resistance, Junction-to-Ambient	--	40	$^\circ C/W$

FGH80N60FD2 600V, 80A Field Stop IGBT



Package Marking and Ordering Information

Device Marking	Device	Package	Packaging Type	Qty per Tube	Max Qty per Box
FGH80N60FD2	FGH80N60FD2TU	TO-247	Tube	30ea	-

Electrical Characteristics of the IGBT T_C = 25°C unless otherwise noted

Symbol	Parameter	Test Conditions	Min.	Typ.	Max.	Units
Off Characteristics						
BV _{CE(s)}	Collector-Emitter Breakdown Voltage	V _{GE} = 0V, I _C = 250uA	600	--	--	V
ΔBV _{CE(s)} /ΔT _J	Temperature Coefficient of Breakdown Voltage	V _{GE} = 0V, I _C = 250uA	--	0.6	--	V/°C
I _{CES}	Collector Cut-Off Current	V _{CE} = V _{CE(s)} , V _{GE} = 0V	--	--	250	uA
I _{GES}	G-E Leakage Current	V _{GE} = V _{GES} , V _{CE} = 0V	--	--	±400	nA
On Characteristics						
V _{GE(th)}	G-E Threshold Voltage	I _C = 250uA, V _{CE} = V _{GE}	4.5	5.5	7.0	V
V _{CE(sat)}	Collector to Emitter Saturation Voltage	I _C = 40A, V _{GE} = 15V	--	1.8	2.4	V
		I _C = 40A, V _{GE} = 15V, T _C = 125°C	--	2.05	--	V
Dynamic Characteristics						
C _{ies}	Input Capacitance	V _{CE} = 30V, V _{GE} = 0V, f = 1MHz	--	2110	--	pF
C _{oes}	Output Capacitance		--	200	--	pF
C _{res}	Reverse Transfer Capacitance		--	60	--	pF
Switching Characteristics						
t _{d(on)}	Turn-On Delay Time	V _{CC} = 400 V, I _C = 40A, R _G = 10Ω, V _{GE} = 15V, Inductive Load, T _C = 25°C	--	21	--	ns
t _r	Rise Time		--	56	--	ns
t _{d(off)}	Turn-Off Delay Time		--	126	--	ns
t _f	Fall Time		--	50	100	ns
E _{on}	Turn-On Switching Loss		--	1	1.5	mJ
E _{off}	Turn-Off Switching Loss		--	0.52	0.78	mJ
E _{ts}	Total Switching Loss		--	1.52	2.28	mJ
t _{d(on)}	Turn-On Delay Time	V _{CC} = 400 V, I _C = 40A, R _G = 10Ω, V _{GE} = 15V, Inductive Load, T _C = 125°C	--	20	--	ns
t _r	Rise Time		--	54	--	ns
t _{d(off)}	Turn-Off Delay Time		--	131	--	ns
t _f	Fall Time		--	70	--	ns
E _{on}	Turn-On Switching Loss		--	1.1	--	mJ
E _{off}	Turn-Off Switching Loss		--	0.78	--	mJ
E _{ts}	Total Switching Loss		--	1.88	--	mJ
Q _g	Total Gate Charge	V _{CE} = 400 V, I _C = 40A, V _{GE} = 15V	--	120	--	nC
Q _{ge}	Gate-Emitter Charge		--	14	--	nC
Q _{gc}	Gate-Collector Charge		--	58	--	nC

Electrical Characteristics of the Diode T_C = 25°C unless otherwise noted

Symbol	Parameter	Test Conditions	Min.	Typ.	Max	Units	
V _{FM}	Diode Forward Voltage	I _F = 15A	T _C = 25°C	-	1.2	1.5	V
			T _C = 125°C	-	1.0	-	
t _{rr}	Diode Reverse Recovery Time	I _{ES} = 15A, dI _{ES} /dt = 200A/μs	T _C = 25°C	-	61	-	ns
			T _C = 125°C	-	125	-	
I _{rr}	Diode Reverse Recovery Current	I _{ES} = 15A, dI _{ES} /dt = 200A/μs	T _C = 25°C	-	4.8	-	ns
			T _C = 125°C	-	8.4	-	
Q _{rr}	Diode Reverse Recovery Charge	I _{ES} = 15A, dI _{ES} /dt = 200A/μs	T _C = 25°C	-	146	-	nC
			T _C = 125°C	-	525	-	

Typical Performance Characteristics

Figure 1. Typical Output Characteristics

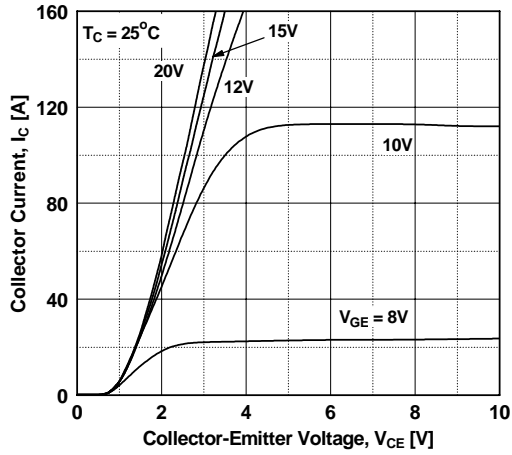

Figure 2. Typical Saturation Voltage Characteristics

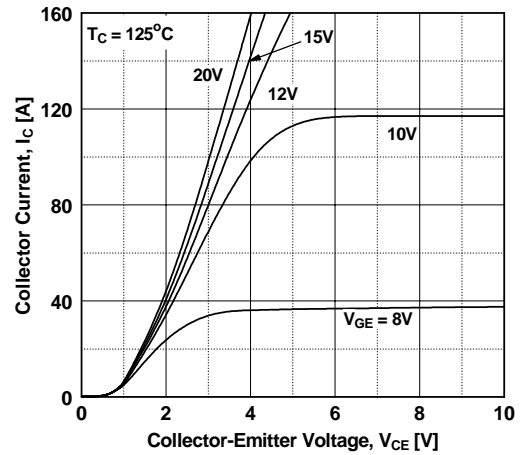

Figure 3. Typical Saturation Voltage Characteristics

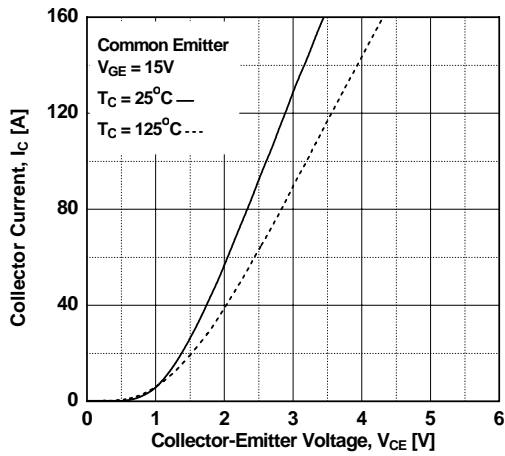

Figure 4. Transfer Characteristics

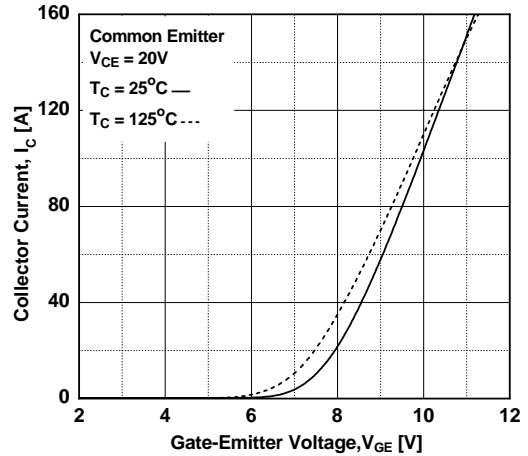

Figure 5. Saturation Voltage vs. Case

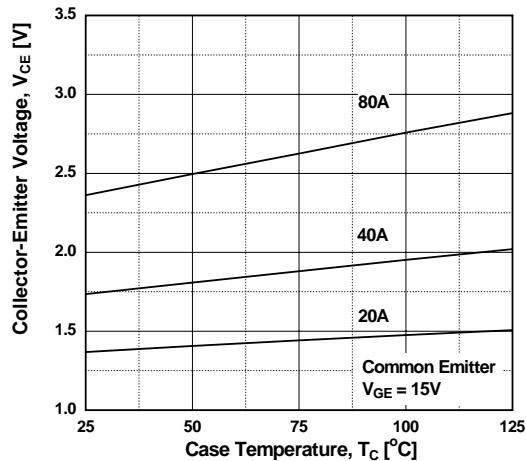
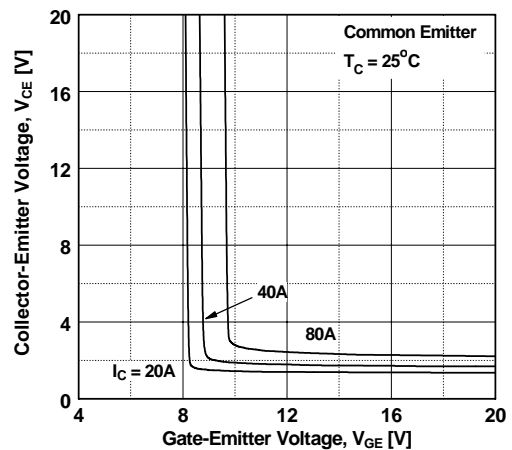

Figure 6. Saturation Voltage vs. Vge



Typical Performance Characteristics (Continued)

Figure 7. Saturation Voltage vs. V_{GE}

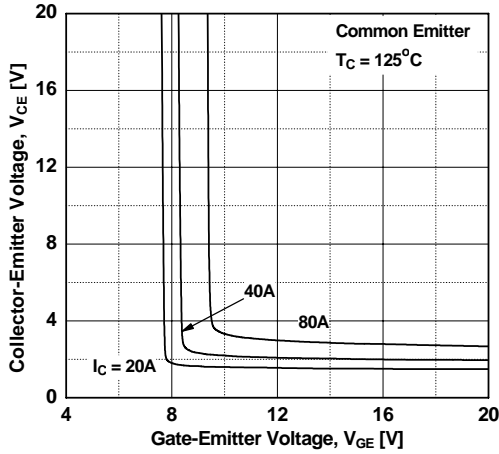

Figure 8. Capacitance Characteristics

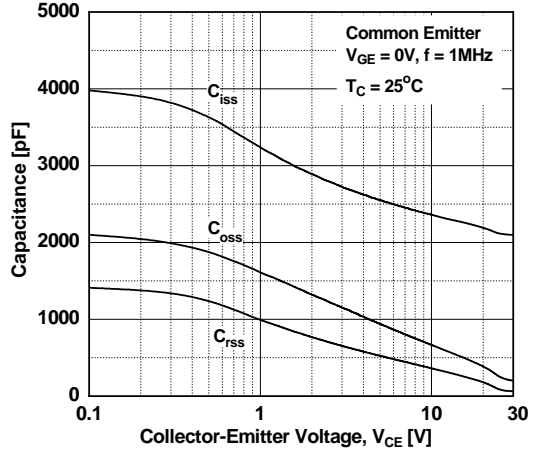

Figure 9. Gate Charge Characteristics

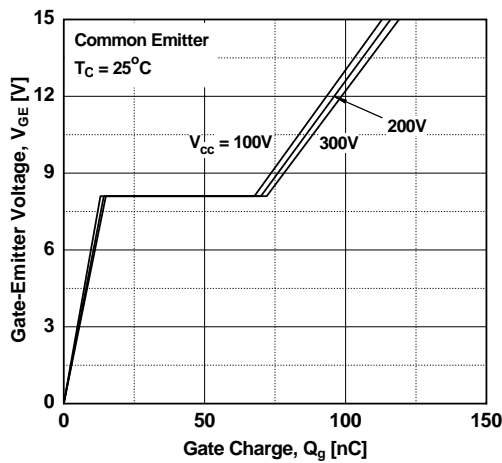

Figure 10. SOA Characteristics

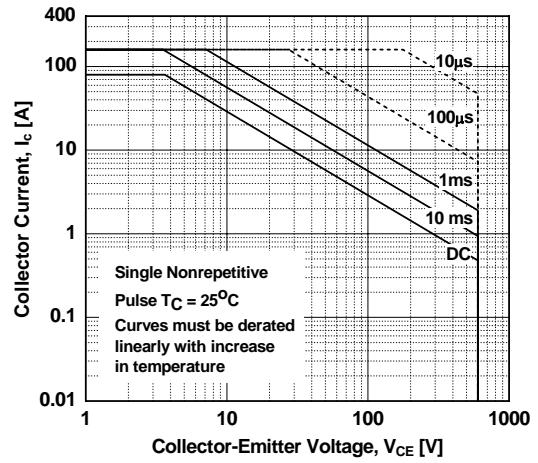

Figure 11. Turn-Off Switching SOA Characteristics

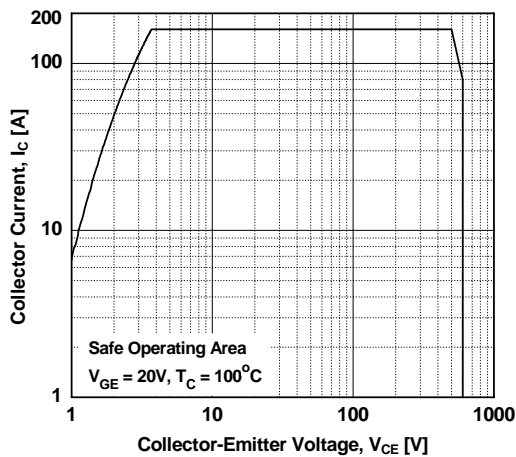
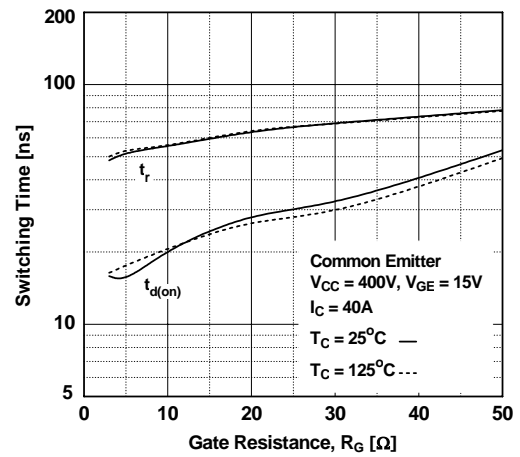

Figure 12. Turn-On Characteristics vs. Gate Resistance



Typical Performance Characteristics (Continued)

Figure 13. Turn-Off Characteristics vs. Gate Resistance

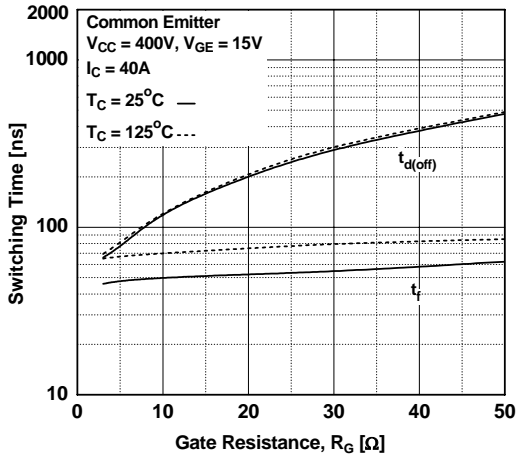

Figure 14. Turn-On Characteristics vs. Collector Current

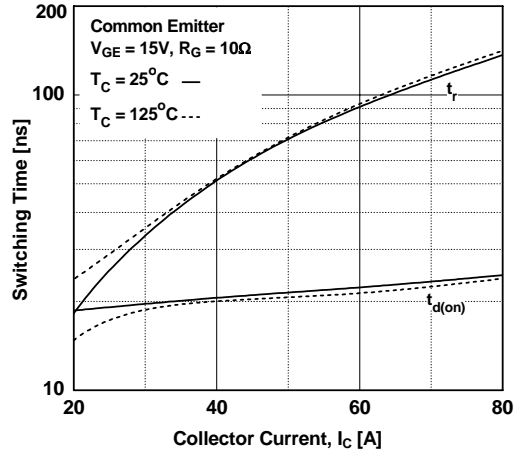

Figure 15. Turn-Off Characteristics vs. Collector Current

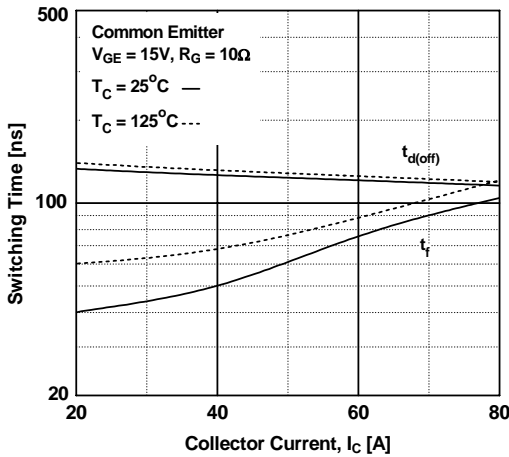

Figure 16. Switching Loss vs Gate Resistance

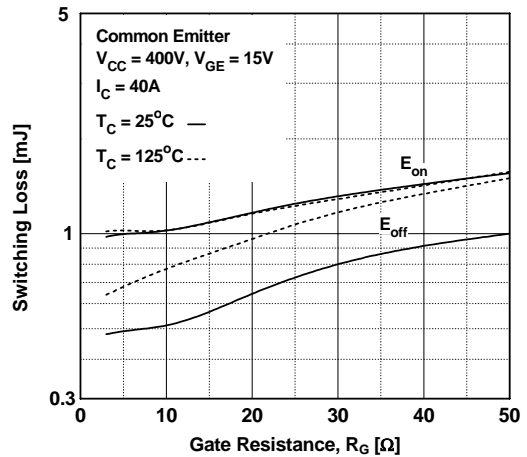
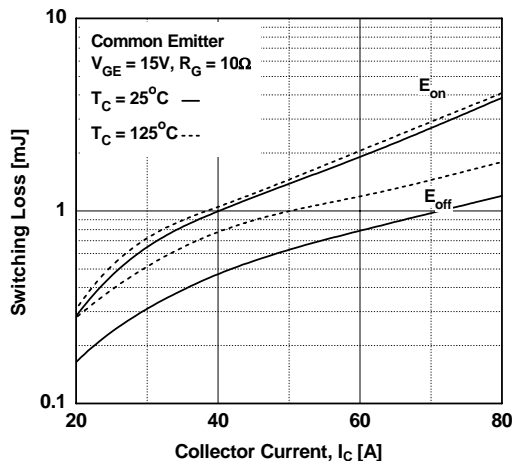

Figure 17. Switching Loss vs Collector Current



Typical Performance Characteristics (Continued)

Figure 18. Transient Thermal Impedance of IGBT

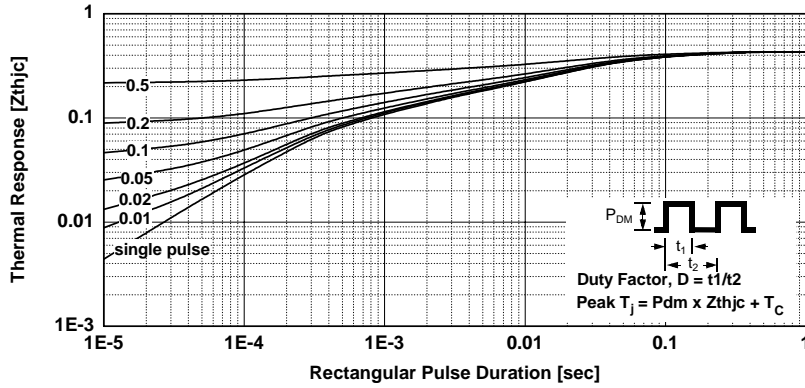

Figure 19. Typical Forward Voltage Drop

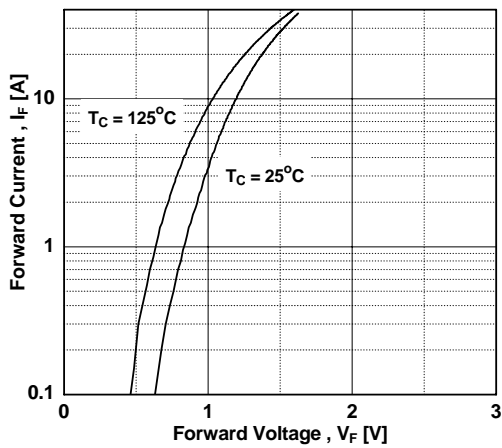

Figure 20. Stored Charge

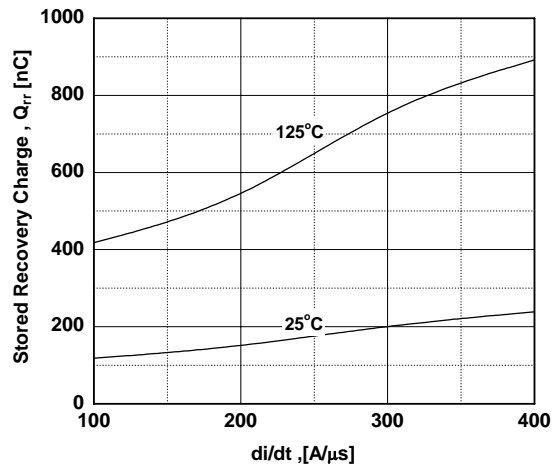

Figure 21. Reverse Recovery Time

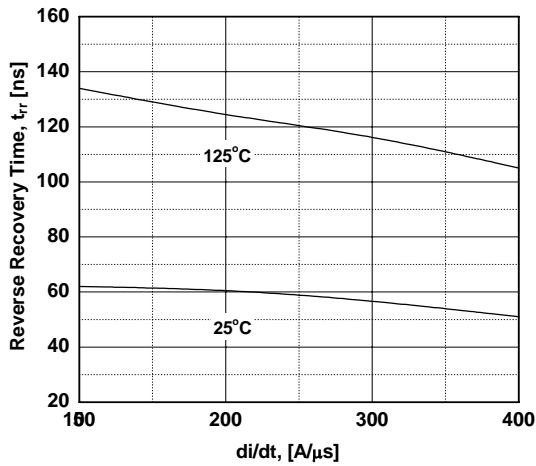
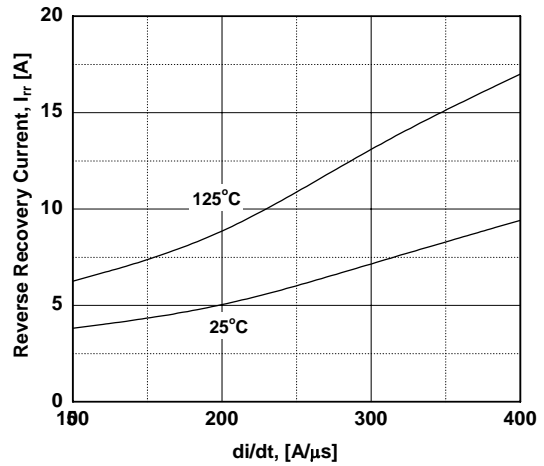



Figure 22. Reverse Recovery Current





TRADEMARKS

The following are registered and unregistered trademarks and service marks Fairchild Semiconductor owns or is authorized to use and is not intended to be an exhaustive list of all such trademarks.

ACEx®	Green FPS™ e-Series™	Power-SPM™	SyncFET™
Build it Now™	GOT™	PowerTrench®	The Power Franchise®
CorePLUS™	i-Lo™	Programmable Active Droop™	 ™
CROSSVOLT™	IntelliMAX™	QFET®	TinyBoost™
CTL™	ISOPLANAR™	QS™	TinyBuck™
Current Transfer Logic™	MegaBuck™	QT Optoelectronics™	TinyLogic®
EcoSPARK®	MICROCOUPLER™	Quiet Series™	TINYOPTO™
FACT Quiet Series™	MicroPak™	RapidConfigure™	TinyPower™
FACT®	Motion-SPM™	SMART START™	TinyPWM™
FAST®	OPTOLOGIC®	SPM®	TinyWire™
FastvCore™	OPTOPLANAR®	STEALTH™	µSerDes™
FPS™	PDP-SPM™	SuperFET™	UHC®
FRFET®	Power220®	SuperSOT™-3	UniFET™
Global Power ResourceSM	Power247®	SuperSOT™-6	VCX™
Green FPS™	POEWEREDGE®	SuperSOT™-8	

DISCLAIMER

FAIRCHILD SEMICONDUCTOR RESERVES THE RIGHT TO MAKE CHANGES WITHOUT FURTHER NOTICE TO ANY PRODUCTS HEREIN TO IMPROVE RELIABILITY, FUNCTION, OR DESIGN. FAIRCHILD DOES NOT ASSUME ANY LIABILITY ARISING OUT OF THE APPLICATION OR USE OF ANY PRODUCT OR CIRCUIT DESCRIBED HEREIN; NEITHER DOES IT CONVEY ANY LICENSE UNDER ITS PATENT RIGHTS, NOR THE RIGHTS OF OTHERS. THESE SPECIFICATIONS DO NOT EXPAND THE TERMS OF FAIRCHILD'S WORLDWIDE TERMS AND CONDITIONS, SPECIFICALLY THE WARRANTY THEREIN, WHICH COVERS THESE PRODUCTS.

LIFE SUPPORT POLICY

FAIRCHILD'S PRODUCTS ARE NOT AUTHORIZED FOR USE AS CRITICAL COMPONENTS IN LIFE SUPPORT DEVICES OR SYSTEMS WITHOUT THE EXPRESS WRITTEN APPROVAL OF FAIRCHILD SEMICONDUCTOR CORPORATION.

As used herein:

- Life support devices or systems are devices or systems which, (a) are intended for surgical implant into the body or (b) support or sustain life, and (c) whose failure to perform when properly used in accordance with instructions for use provided in the labeling, can be reasonably expected to result in a significant injury of the user.
- A critical component in any component of a life support, device, or system whose failure to perform can be reasonably expected to cause the failure of the life support device or system, or to affect its safety or effectiveness.

PRODUCT STATUS DEFINITIONS

Definition of Terms

Datasheet Identification	Product Status	Definition
Advance Information	Formative or In Design	This datasheet contains the design specifications for product development. Specifications may change in any manner without notice.
Preliminary	First Production	This datasheet contains preliminary data; supplementary data will be published at a later date. Fairchild Semiconductor reserves the right to make changes at any time without notice to improve design.
No Identification Needed	Full Production	This datasheet contains final specifications. Fairchild Semiconductor reserves the right to make changes at any time without notice to improve design.
Obsolete	Not In Production	This datasheet contains specifications on a product that has been discontinued by Fairchild Semiconductor. The datasheet is printed for reference information only.

Rev. I28