

MITSUBISHI Nch POWER MOSFET

# FK20SM-5

HIGH-SPEED SWITCHING USE

## FK20SM-5



- V<sub>DSS</sub> ..... 250V
- r<sub>DS (ON)</sub> (MAX) ..... 0.24Ω
- I<sub>D</sub> ..... 20A
- Integrated Fast Recovery Diode (MAX.) ..... 150ns

## OUTLINE DRAWING

Dimensions in mm

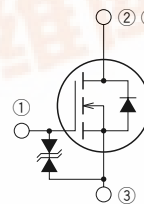
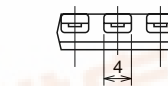
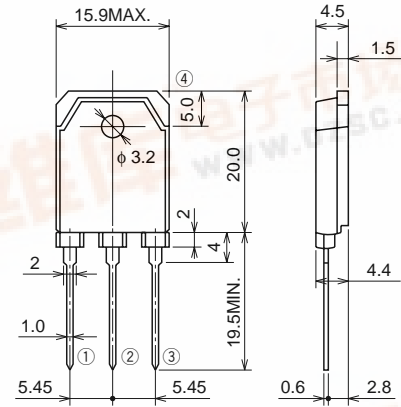

- ① GATE
- ② DRAIN
- ③ SOURCE
- ④ DRAIN

TO-3P

## APPLICATION

Servo motor drive, Robot, UPS, Inverter Fluorecent lamp, etc.

## MAXIMUM RATINGS (T<sub>c</sub> = 25°C)

Symbol	Parameter	Conditions	Ratings	Unit
V <sub>DSS</sub>	Drain-source voltage	V <sub>GS</sub> = 0V	250	V
V <sub>GSS</sub>	Gate-source voltage	V <sub>DS</sub> = 0V	±30	V
I <sub>D</sub>	Drain current		20	A
I <sub>DM</sub>	Drain current (Pulsed)		60	A
I <sub>S</sub>	Source current		20	A
I <sub>SM</sub>	Source current (Pulsed)		60	A
P <sub>D</sub>	Maximum power dissipation		150	W
T <sub>ch</sub>	Channel temperature		-55 ~ +150	°C
T <sub>stg</sub>	Storage temperature		-55 ~ +150	°C
—	Weight	Typical value	4.8	g



# FK20SM-5

HIGH-SPEED SWITCHING USE

## ELECTRICAL CHARACTERISTICS (Tch = 25°C)

Symbol	Parameter	Test conditions	Limits			Unit
			Min.	Typ.	Max.	
V (BR) DSS	Drain-source breakdown voltage	ID = 1mA, VGS = 0V	250	—	—	V
V (BR) GSS	Gate-source breakdown voltage	IG = ±100μA, VDS = 0V	±30	—	—	V
IGSS	Gate-source leakage current	VGS = ±25V, VDS = 0V	—	—	±10	μA
IDSS	Drain-source leakage current	VDS = 250V, VGS = 0V	—	—	1	mA
VGS (th)	Gate-source threshold voltage	ID = 1mA, VDS = 10V	2	3	4	V
rDS (ON)	Drain-source on-state resistance	ID = 10A, VGS = 10V	—	0.19	0.24	Ω
VDS (ON)	Drain-source on-state voltage	ID = 10A, VGS = 10V	—	1.9	2.4	V
yfs	Forward transfer admittance	ID = 10A, VDS = 10V	8.5	13.0	—	S
Ciss	Input capacitance	VDS = 25V, VGS = 0V, f = 1MHz	—	1400	—	pF
Coss	Output capacitance		—	280	—	pF
Crss	Reverse transfer capacitance		—	55	—	pF
td (on)	Turn-on delay time	VDD = 150V, ID = 10A, VGS = 10V, RGEN = RGS = 50Ω	—	25	—	ns
tr	Rise time		—	50	—	ns
td (off)	Turn-off delay time		—	150	—	ns
tf	Fall time		—	65	—	ns
VSD	Source-drain voltage	IS = 10A, VGS = 0V	—	1.5	2.0	V
Rth (ch-c)	Thermal resistance	Channel to case	—	—	0.83	°C/W
trr	Reverse recovery time	IS = 20A, dis/dt = -100A/μs	—	—	150	ns

## PERFORMANCE CURVES

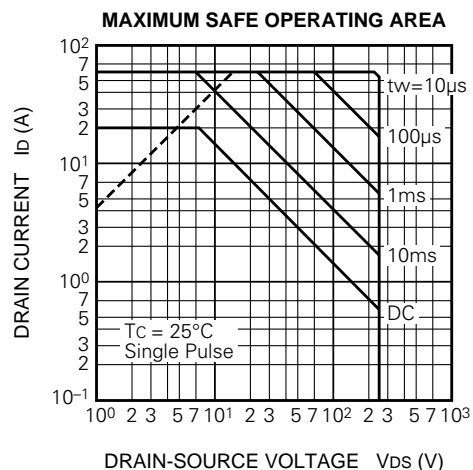
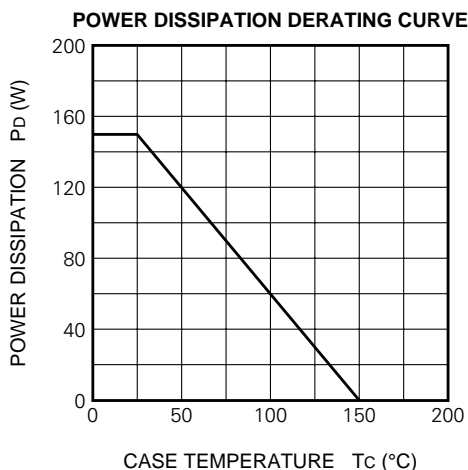

# FK20SM-5

HIGH-SPEED SWITCHING USE

**OUTPUT CHARACTERISTICS (TYPICAL)**

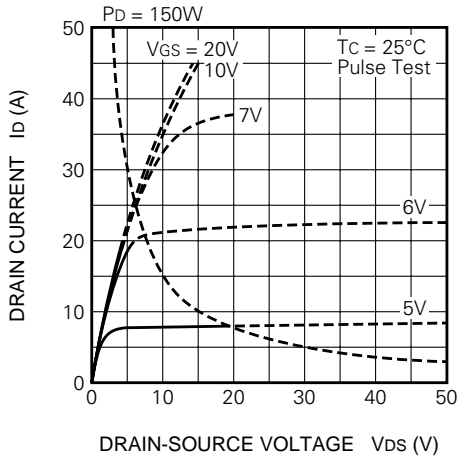

**OUTPUT CHARACTERISTICS (TYPICAL)**

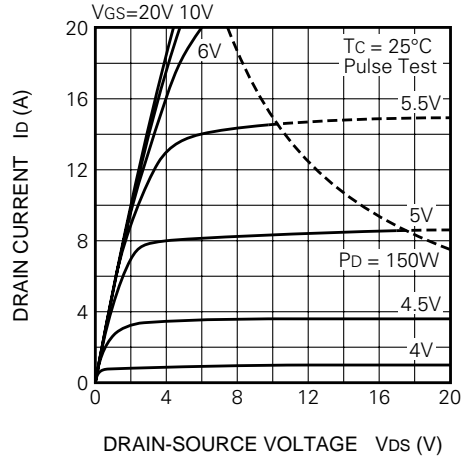

**ON-STATE VOLTAGE VS. GATE-SOURCE VOLTAGE (TYPICAL)**

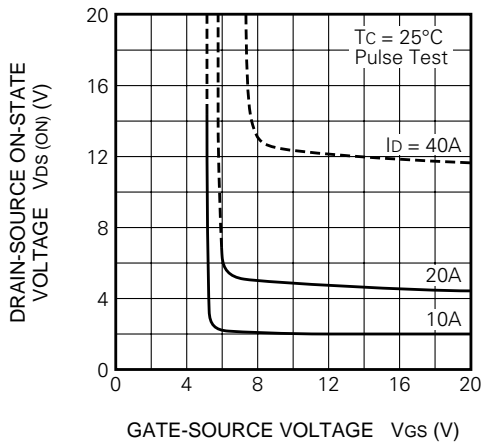

**ON-STATE RESISTANCE VS. DRAIN CURRENT (TYPICAL)**

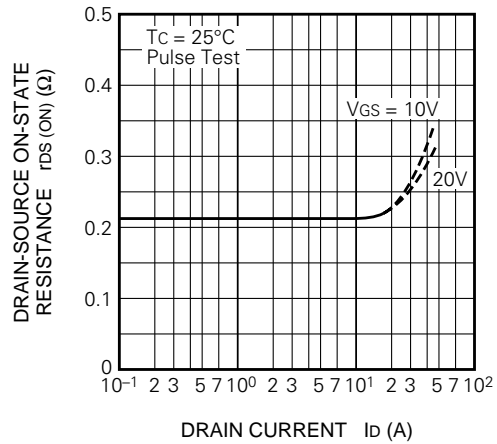

**TRANSFER CHARACTERISTICS (TYPICAL)**

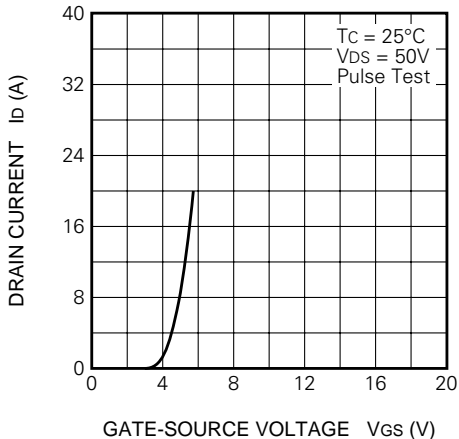

**FORWARD TRANSFER ADMITTANCE VS. DRAIN CURRENT (TYPICAL)**

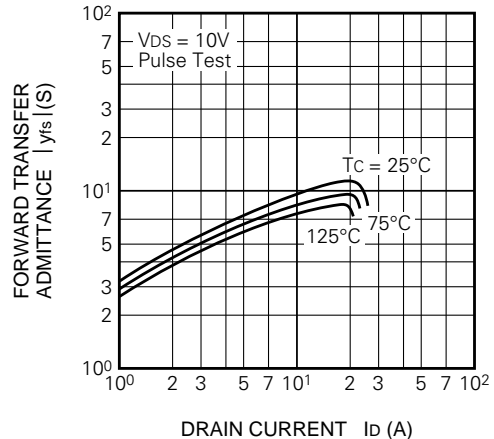

# FK20SM-5

## HIGH-SPEED SWITCHING USE

**CAPACITANCE VS. DRAIN-SOURCE VOLTAGE (TYPICAL)**

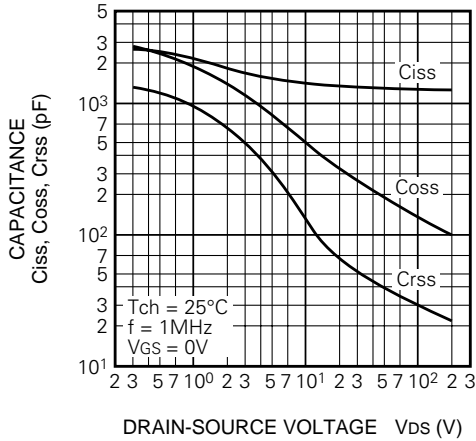

**SWITCHING CHARACTERISTICS (TYPICAL)**

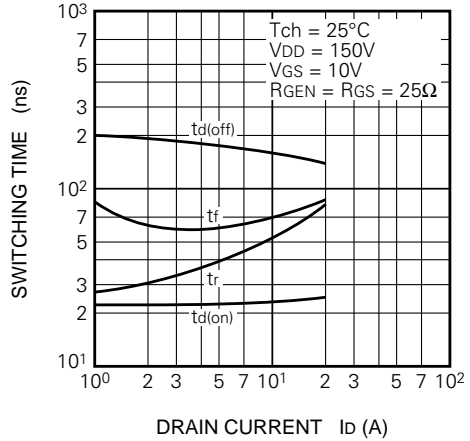

**GATE-SOURCE VOLTAGE VS. GATE CHARGE (TYPICAL)**

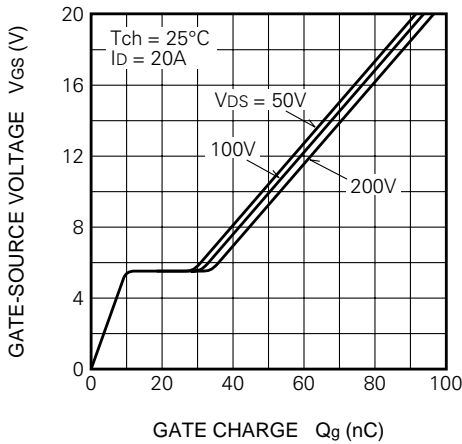

**SOURCE-DRAIN DIODE FORWARD CHARACTERISTICS (TYPICAL)**

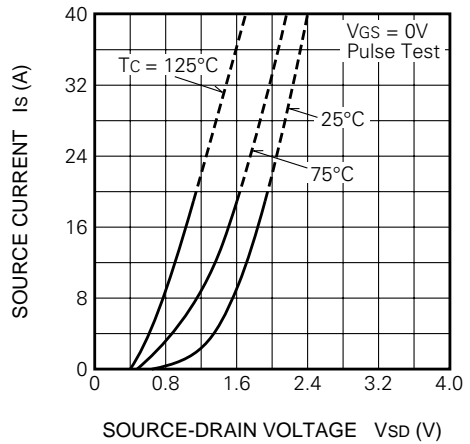

**ON-STATE RESISTANCE VS. CHANNEL TEMPERATURE (TYPICAL)**

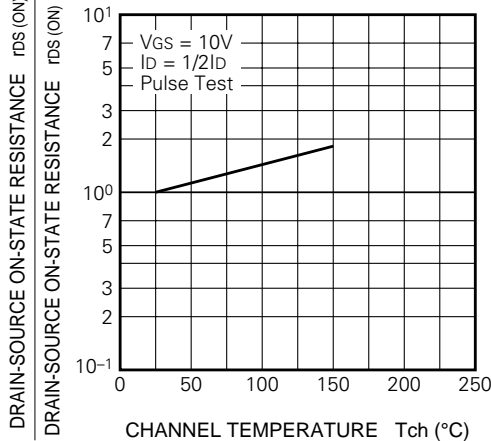

**THRESHOLD VOLTAGE VS. CHANNEL TEMPERATURE (TYPICAL)**

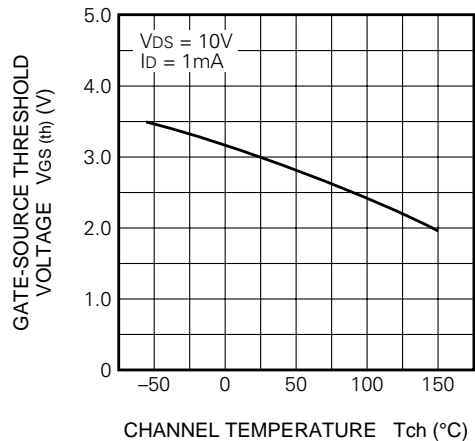

FK20SM-5

HIGH-SPEED SWITCHING USE

