

FEATURES

- -55°C to +125°C operation
- Up to 60 dB attenuation at 500 kHz.
- Compliant to MIL-STD-461C, CE03
- Compatible with MIL-STD-704E DC power bus

EMI INPUT FILTERS 28 & 270 VOLT INPUT

FMD/FME EMI FILTER 0.7 TO 15 AMP



MODELS	
INPUT VOLTAGE AND CURRENT	
Input (V)	Current (A)
28	7.0
28	15.0
270	0.7
270	1.5

Size (max.): Case U2, FME all models; Case U1, FMD28-461SL and FMD270-461SL
3.005 x 1.505 x 0.400 inches (76.33 x 38.23 x 11.16 mm)
[FME models, shown in Case U2 (flanged, short leads). Also available:
Flanged – leads bent down (case V); Tabbed – leads bent up (case W), short leads (case Y), and leads bent down (case Z). See Section B8, cases U2, V, W, Y, and Z for dimensions and options.]
Case J4, FMD28-461
2.720 x 1.350 x 0.505 inches (69.09 x 34.29 x 12.83 mm)
See Section B8, cases J4, U1, U2, V, W, Y, and Z for dimensions.
Weight: 77 grams typical cases U1, U2, V, W, Y, and Z; 55 grams typical case J4
Screening: Standard, ES, or 883 (Class H).
See Section C2 for screening options, see Section A5 for ordering information.

DESCRIPTION

The FMD Series™ and FME Series™ EMI filters are specifically designed to reduce the reflected input ripple current of Interpoint's high frequency DC/DC converters. FMD/FME filters minimize electromagnetic interference (EMI) for the MHE, MHL, MLP, MRH, MTO, MHF, MHF+, MHV, MHD, MTR, MFL, MHP, and MFLHP Series. These filters are intended for use in 28 or 270 volt applications which must meet MIL-STD-461C, CE03 levels of conducted emissions. One filter can be used with multiple converters up to the rated output current of the filter.

INPUT RIPPLE AND EMI

Switching DC/DC converters naturally generate two noise components on the power input line: differential noise and common mode noise. Input ripple current refers to both of these components. Differential noise occurs between the positive input and input common. Most Interpoint converters have an input filter that reduces differential noise which is sufficient for many applications. Common mode noise occurs across stray capacitances between the converter's power train components and the baseplate (bottom of the package) of the converter.

Where low noise currents are required to meet CE03 of MIL-STD-461, a power line filter is needed. The FMD/FME Series of EMI power line filters reduces the common mode and differential noise generated by the converters. FMD/FME-461 filters reduce input ripple current by as much as 60 dB at 500 kHz and 55 dB at 1 MHz when used in conjunction with Interpoint's DC/DC converters. See Figures 8 and 9.

Place the filter as close as possible to the converter for optimum performance. The baseplates of the filter and the converter should be connected with the shortest and widest possible conductors. For the

best connection, mount the filter's and converter's baseplates on or above a small ground plane. See Figure 5.

TRANSIENTS

The transients listed below will not damage the filter but will be passed on to the converter:

- All filters: ±600 volts (50 ohm source impedance) for up to 10 µs.
- 28 volt filter: ±100 volts (0.5 ohm source impedance) for up to 100 ms.
- 270 volt filter: ±500 volts (independent of source impedance) for up to 100 ms.

OPERATION OVER TEMPERATURE

All FMD/FME-461 Series filters are rated for full power operation from -55°C to +125°C case temperature. Current is derated linearly to zero at +135°C case temperature.

INSERTION LOSS

The maximum dc insertion loss at full load and nominal input voltage represents a power loss of less than 4%.

PACKAGING

FMD/FME-461 filters are sealed in metal hermetic side-leaded packages. See Section B8, cases U1, U2, V, W, Y, and Z. Additionally the FMD28-461 filter is available in a metal hermetic down-leaded package (see Section B8, case J4).

LAYOUT REQUIREMENTS

The case of the filter must be connected to the case of the converter through a low impedance connection to minimize EMI.



FMD/FME EMI FILTER EMI INPUT FILTERS

0.7 TO 15 AMP

ABSOLUTE MAXIMUM RATINGS	
Input Voltage	<ul style="list-style-type: none"> 0 to 40 VDC continuous for 28 V models 0 to 400 VDC continuous for 270 V models
Lead Soldering Temperature (10 sec per lead)	<ul style="list-style-type: none"> 300°C
Storage Temperature Range (Case)	<ul style="list-style-type: none"> -65°C to +150°C
Isolation	<ul style="list-style-type: none"> 100 megohm minimum at 500 V, any pin to case (except FMD downloaded case case pin)

RECOMMENDED OPERATING CONDITIONS	
Input Voltage Range	<ul style="list-style-type: none"> 0 to 40 VDC continuous for 28 V models 0 TO 400 VDC continuous for 270 V models
Case Operating Temperature (Tc)	<ul style="list-style-type: none"> -55°C to +125°C full power -55°C to +135°C absolute
Derating Input/Output Current	<ul style="list-style-type: none"> Linearly from 100% at 125°C to 0% at 135° C

Electrical Characteristics: 25°C Tc, nominal Vin, unless otherwise specified.

PARAMETER	CONDITION	FMD28-461			FMD270-461			FME28-461			FME270-461			UNITS
		MIN	TYP	MAX	MIN	TYP	MAX	MIN	TYP	MAX	MIN	TYP	MAX	
INPUT VOLTAGE	CONTINUOUS	0	28	40	0	270	400	0	28	40	0	270	400	VDC
	TRANSIENT 100 ms ¹	-100	—	100	-500	—	500	-100	—	100	-500	—	500	V
NOISE REJECTION	500 kHz	50	60	—	50	60	—	30	40	—	40	50	—	dB
	1 MHz	45	55	—	45	55	—	40	50	—	45	55	—	
DC RESISTANCE (R _{DC})	MAX. CURRENT T _c =25°C	—	—	0.12	—	—	5.0	—	—	0.07	—	—	2.0	Ω
	T _c =125°C	—	—	0.15	—	—	6.3	—	—	0.07	—	—	3.2	
CAPACITANCE	ANY PIN TO CASE	—	20,000	—	—	30,000	—	—	60,000	—	—	60,000	—	pF
OUTPUT VOLTAGE	STEADY STATE	$V_{OUT} = V_{IN} \cdot I_{IN}(R_{DC})$											VDC	
OUTPUT CURRENT	STEADY STATE	—	—	7	—	—	0.7	—	—	15	—	—	1.5	A
POWER DISSIPATION	MAX. CURRENT T _c =25°C	—	—	6.0	—	—	2.5	—	—	15.75	—	—	4.5	W
	T _c =125°C	—	—	7.4	—	—	3.1	—	—	15.75	—	—	7.2	

Note

1. 28 V models = 0.5 Ω source impedance, 270 V models = independent of source impedance.

EMI INPUT FILTERS FMD/FME EMI FILTER

0.7 TO 15 AMP

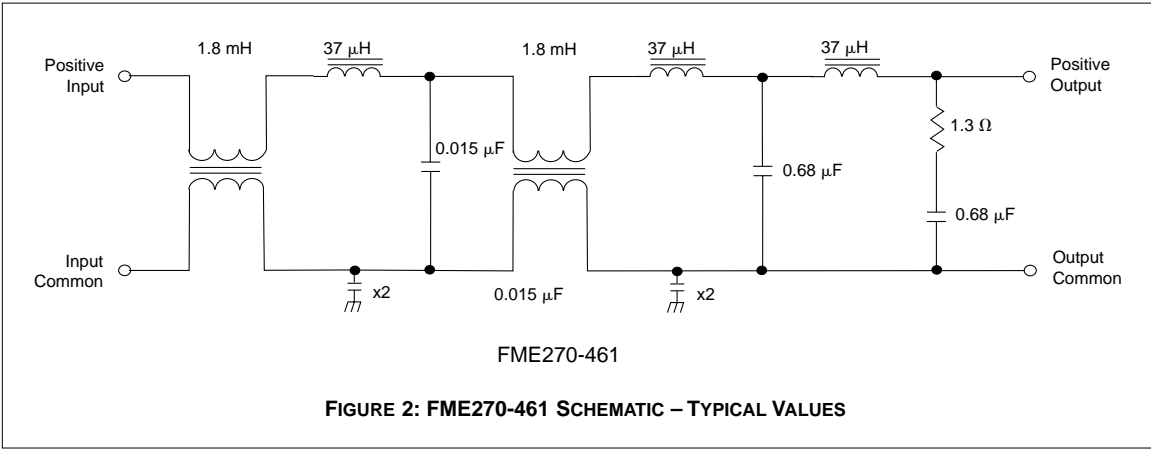
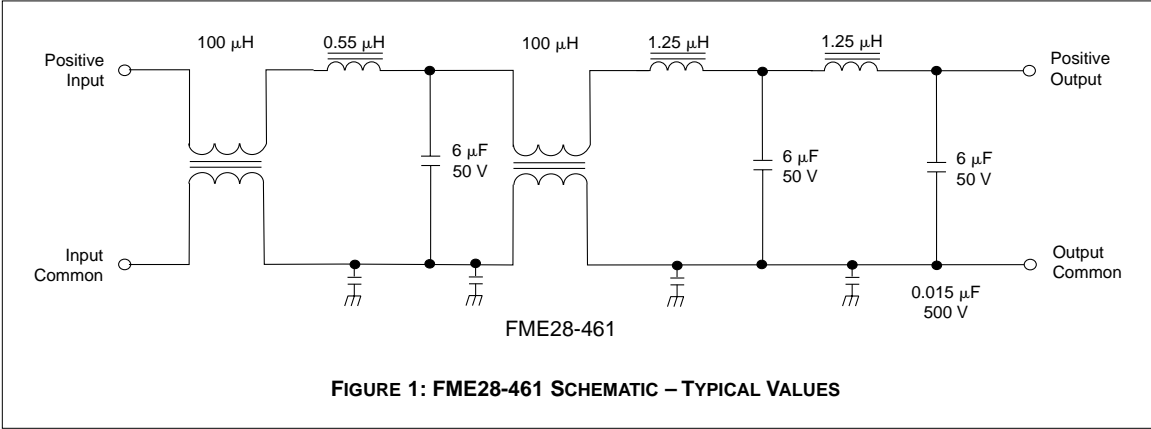

FMD/FME EMI FILTER EMI INPUT FILTERS

0.7 TO 15 AMP

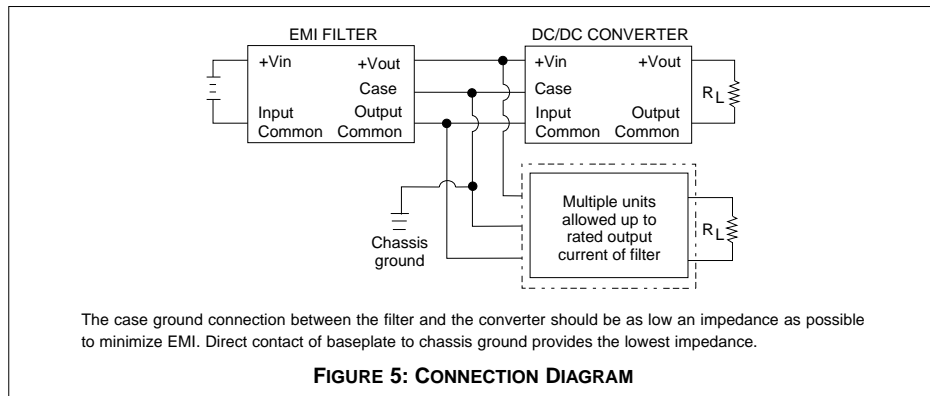
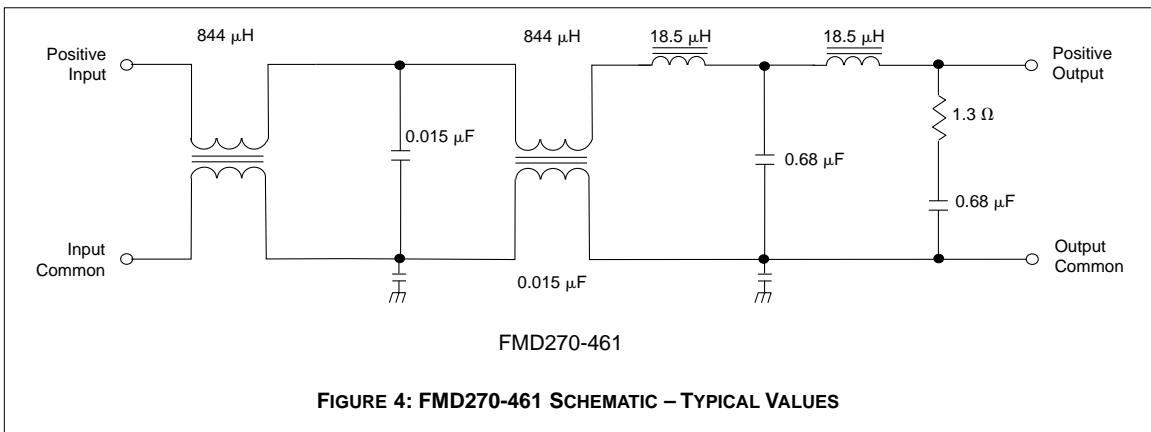
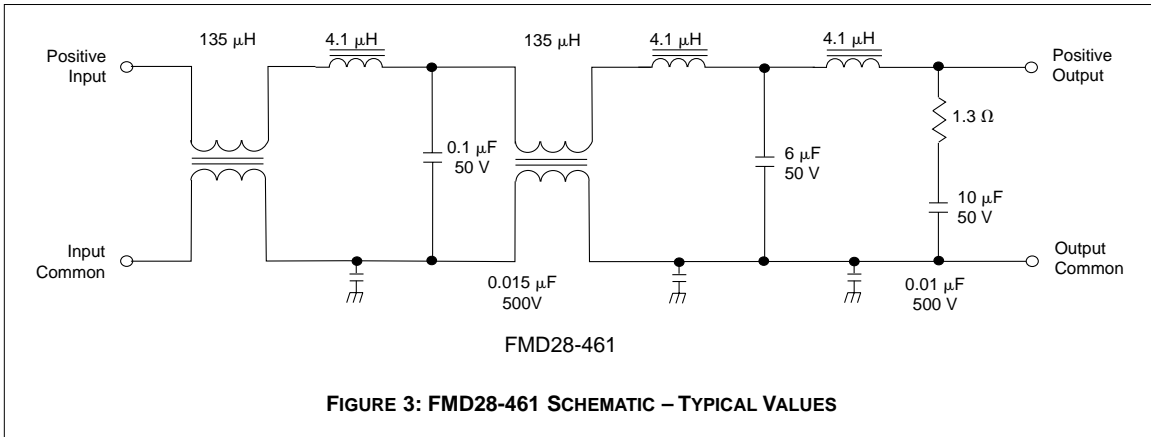

EMI INPUT FILTERS FMD/FME EMI FILTER

0.7 TO 15 AMP

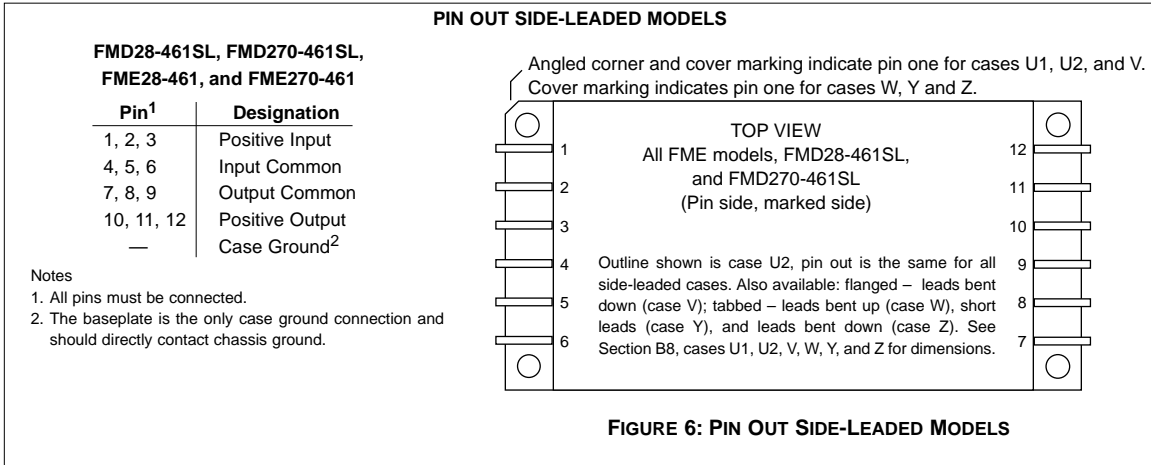

FIGURE 6: PIN OUT SIDE-LEADED MODELS

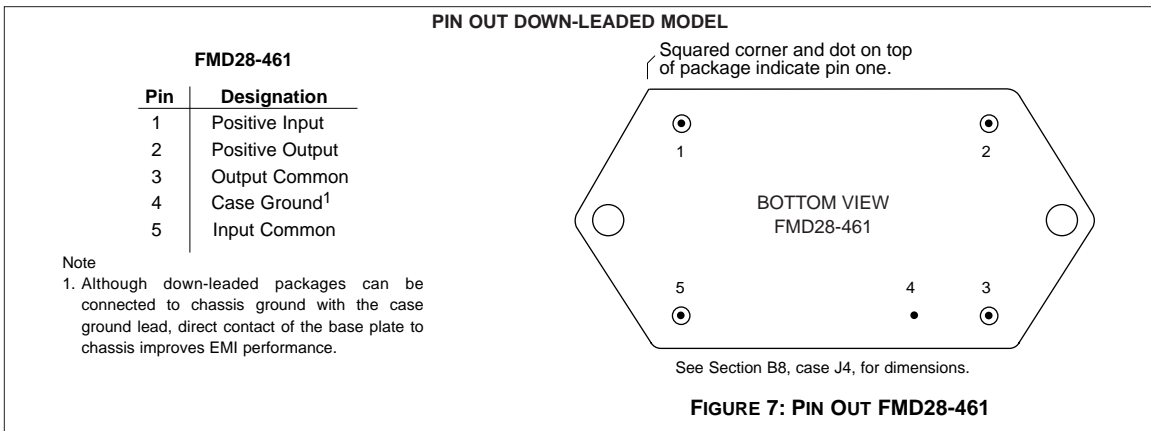
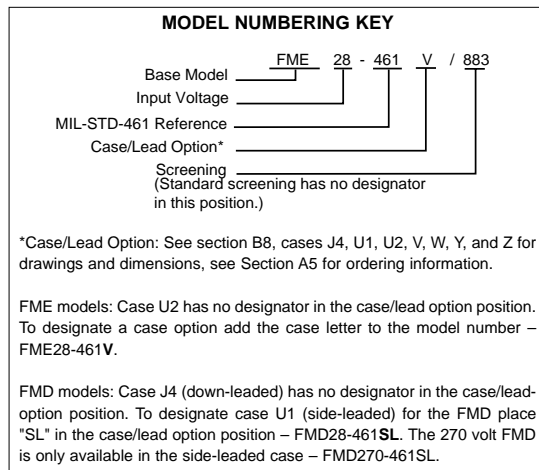

FIGURE 7: PIN OUT FMD28-461

DSCC NUMBERS

DSCC DRAWING (5915)	FME SERIES SIMILAR PART
95004-01HXC	FME28-461/883
95004-01HTC	FME28-461W/883
95004-01HUC	FME28-461V/883
95004-01HYC	FME28-461Y/883
95004-01HZC	FME28-461Z/883
95009-01HXC	FME270-461/883
IN PROCESS	FME270-461W/883
IN PROCESS	FME270-461V/883
IN PROCESS	FME270-461Y/883
IN PROCESS	FME270-461Z/883

For exact specifications for a DSCC product, refer to the DSCC drawing. Contact your Interpoint representative for status on the FME DSCC releases. See Section A3, "SMD/DSCC Lists", for more information.



FMD/FME EMI FILTER EMI INPUT FILTERS

0.7 TO 15 AMP

Typical Performance Curves: 25°C Tc , nominal Vin, unless otherwise specified.

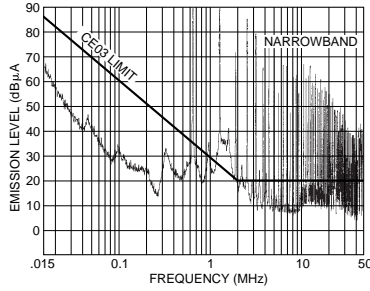

Three paralleled and synchronized MFL2815D converters without filtering.

FIGURE 8

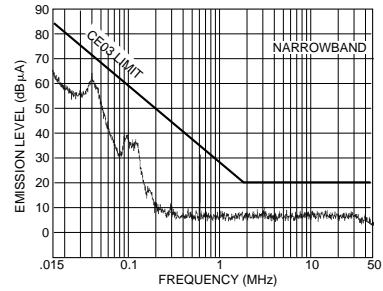

Three paralleled and synchronized MFL2815D converters with an FME28-461.

FIGURE 9

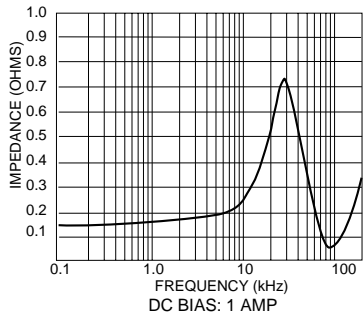

FME28-461 OUTPUT IMPEDANCE

FIGURE 10

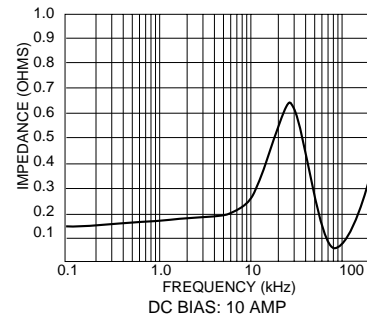

FME28-461 OUTPUT IMPEDANCE

FIGURE 11

CASE U

CASES

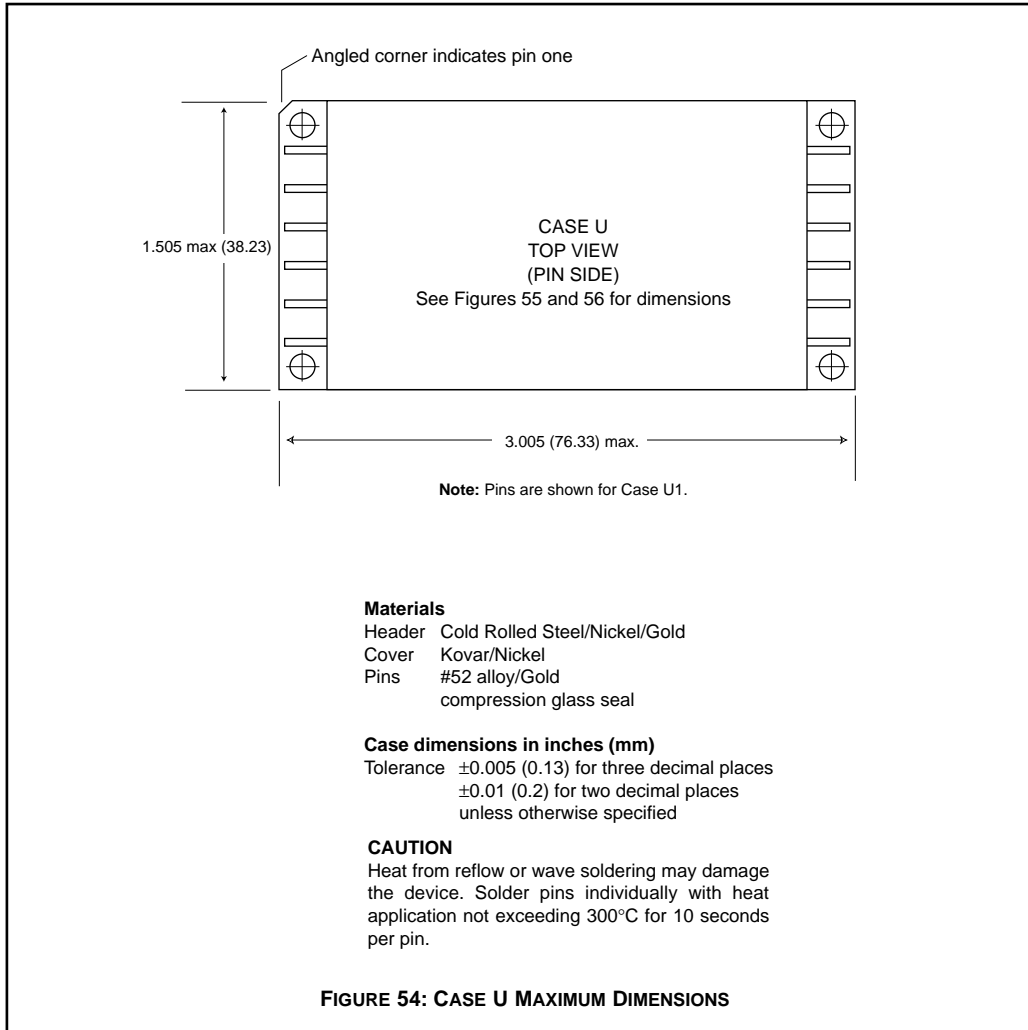

CASE U

CASES

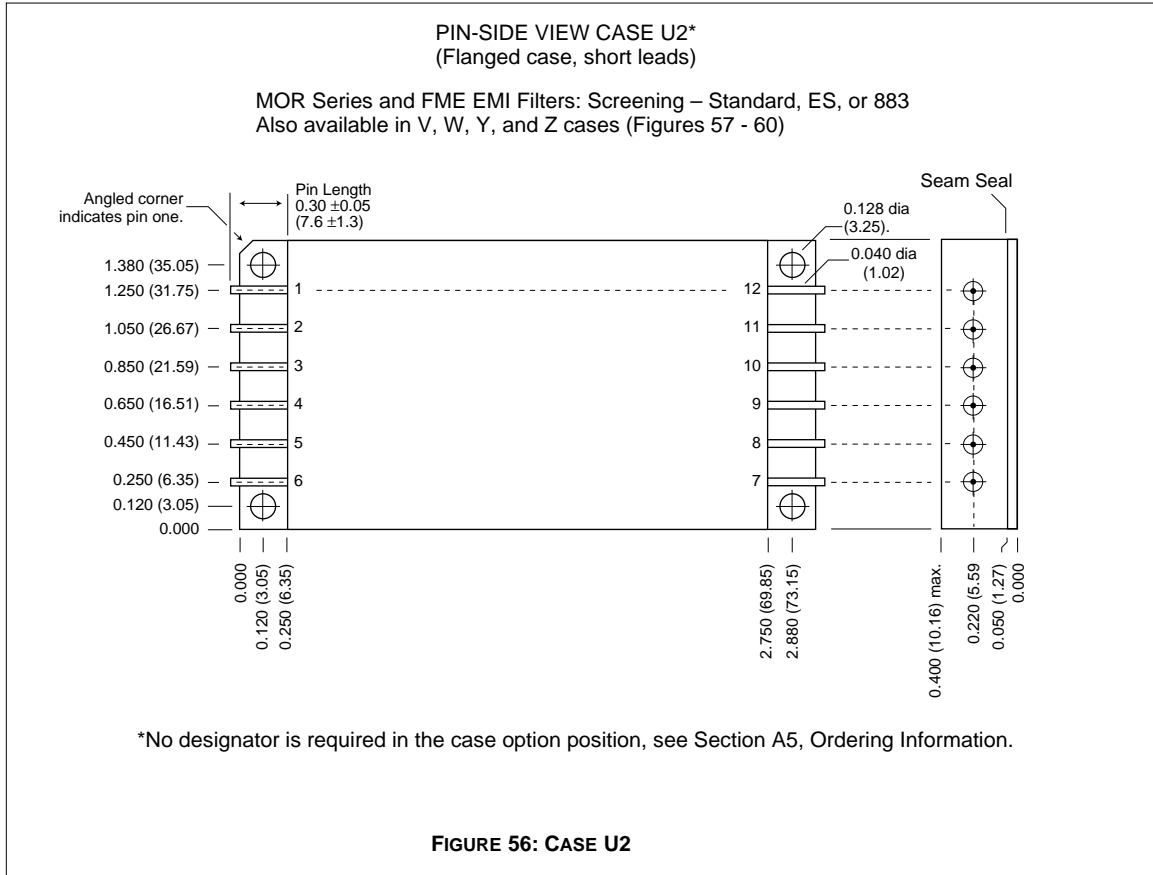

CASES

CASE V

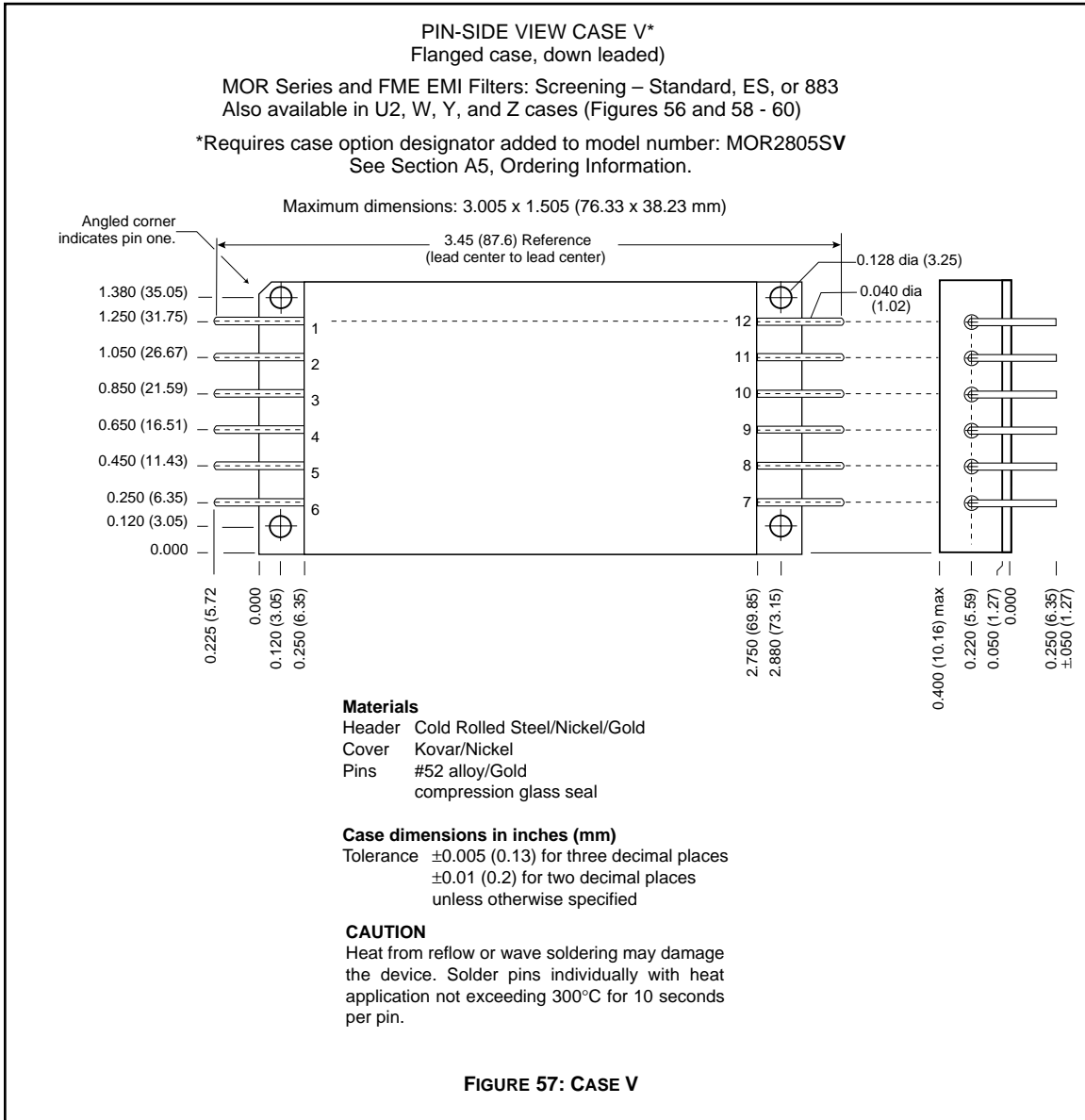

CASE W

CASES

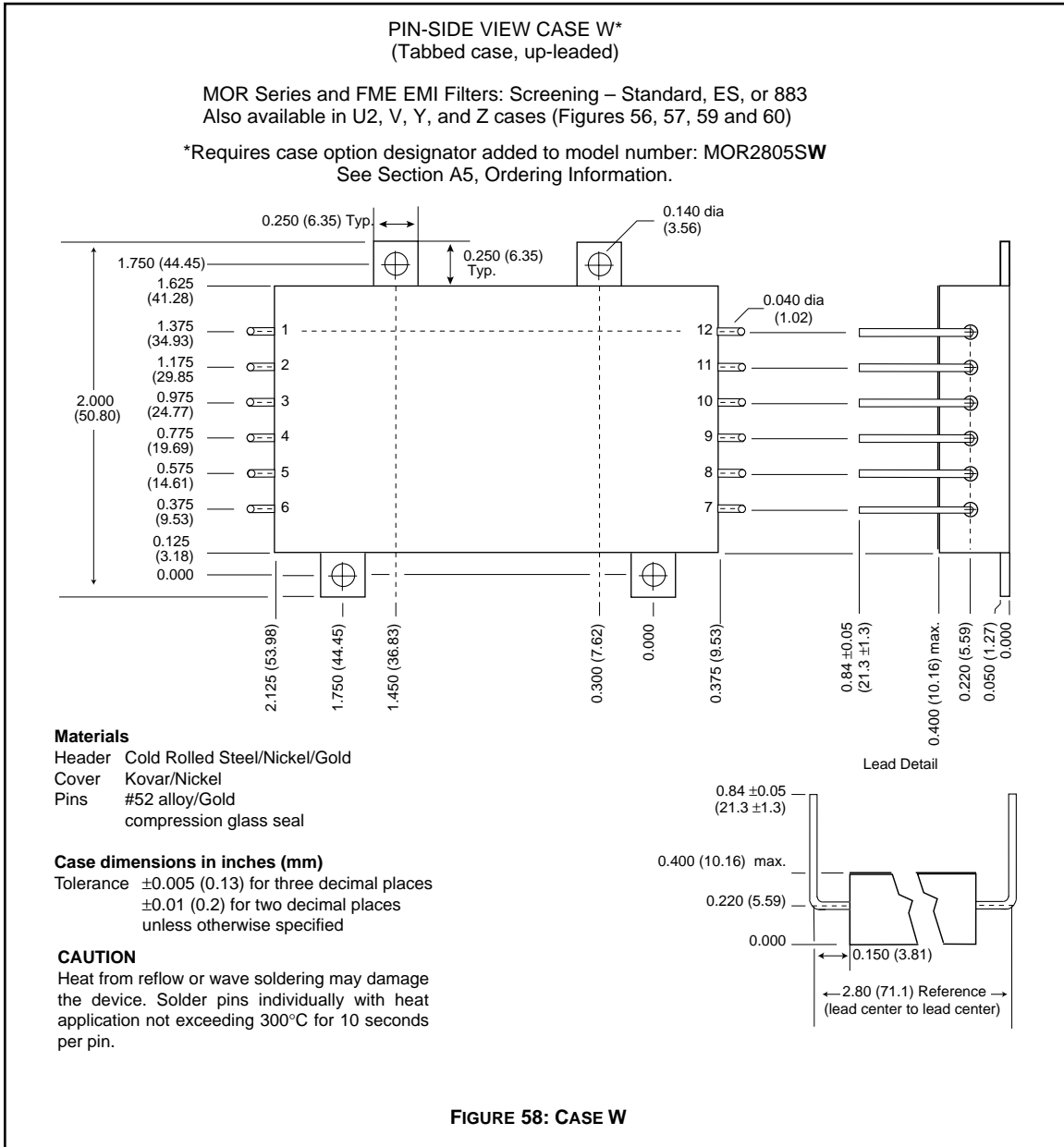

CASES

CASE Y

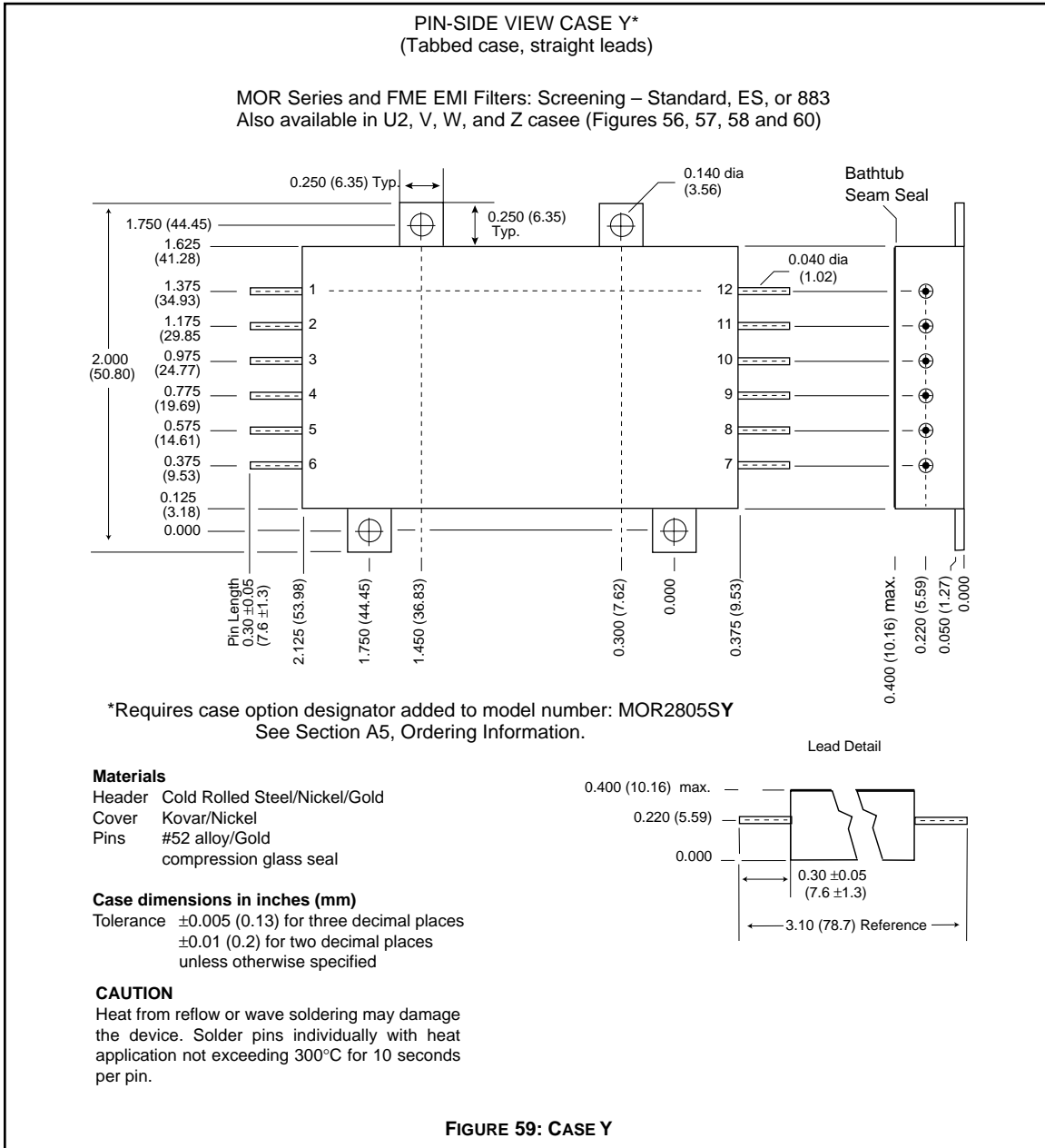

CASE Z

CASES

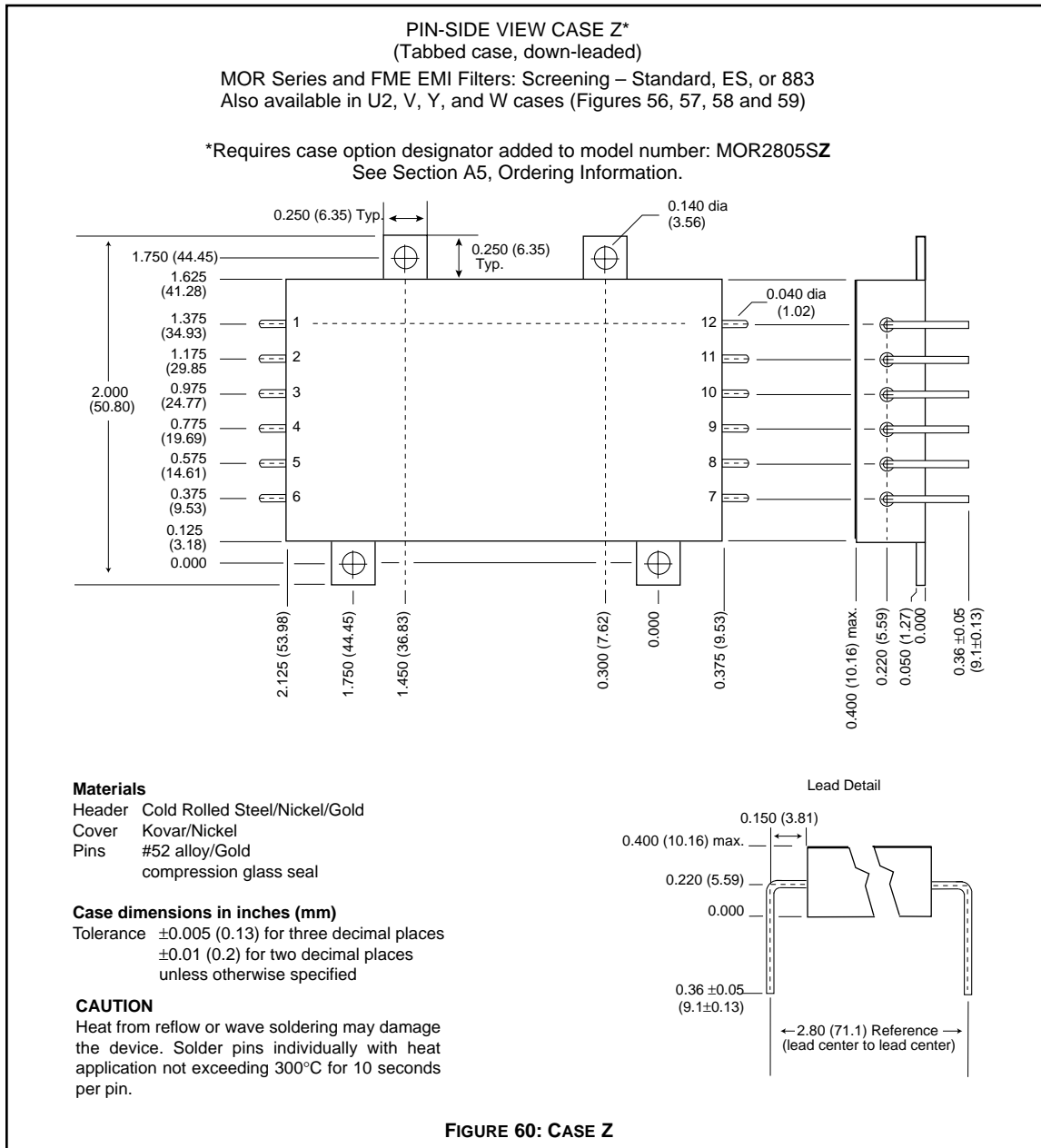

CASES

CASE U

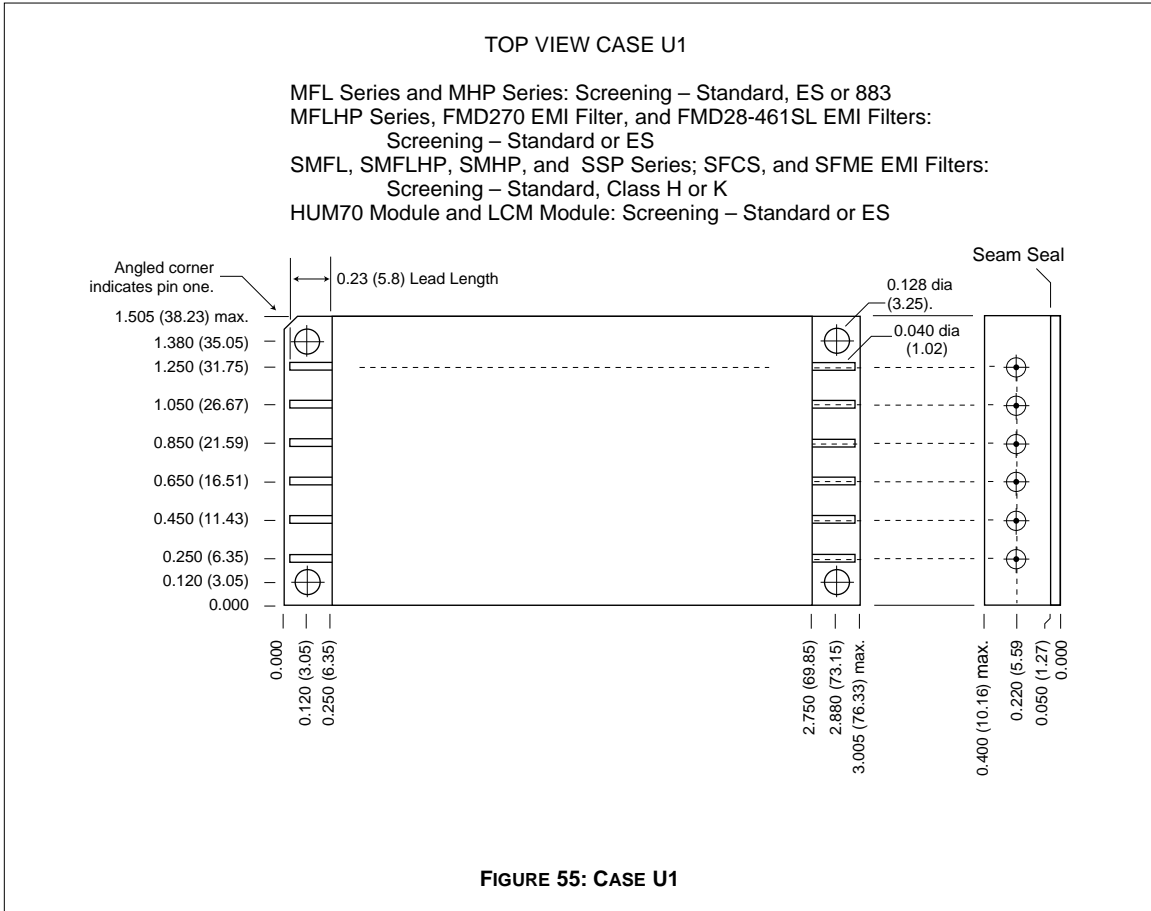

CASE J

CASES

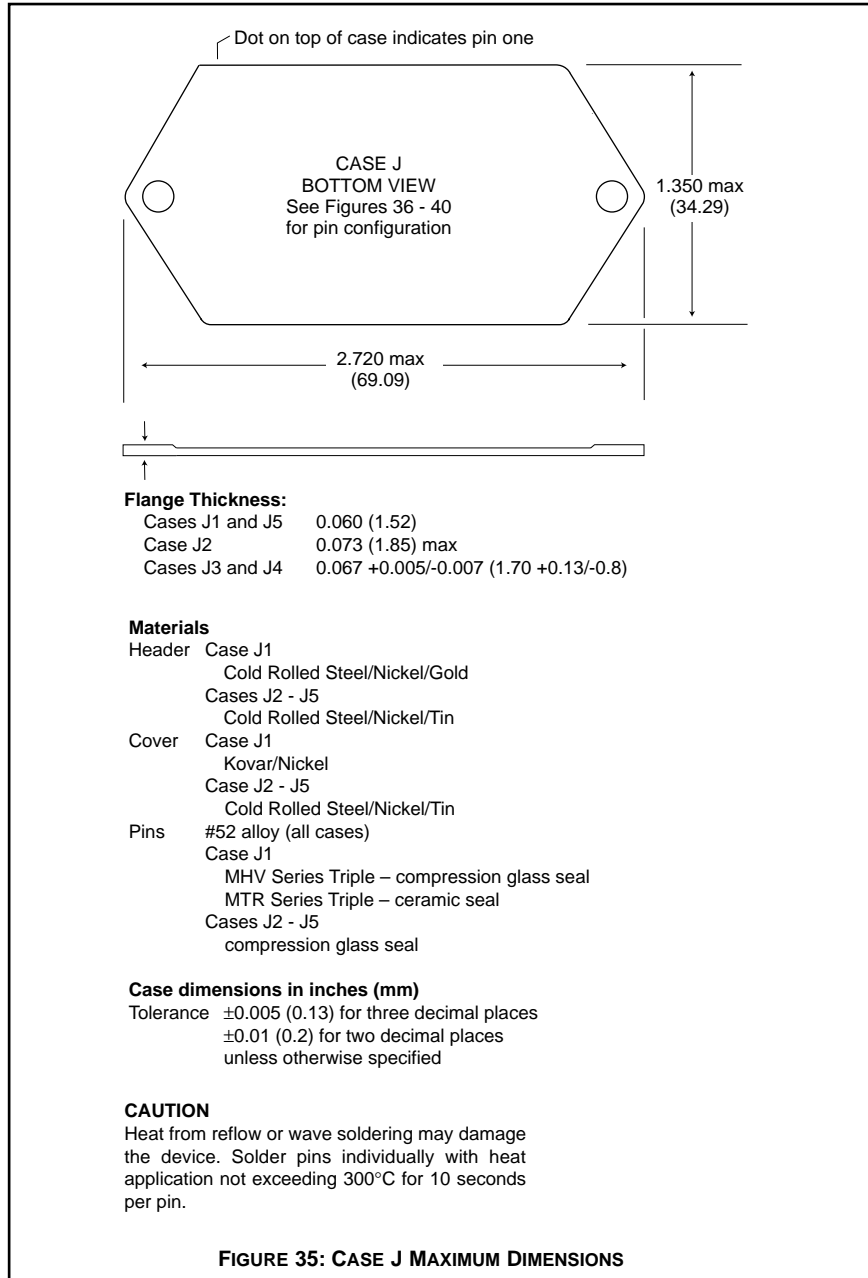

Note: Although every effort has been made to render the case drawings at actual size, variations in the printing process may cause some distortion. Please refer to the numerical dimensions for accuracy.

CASES

CASE J

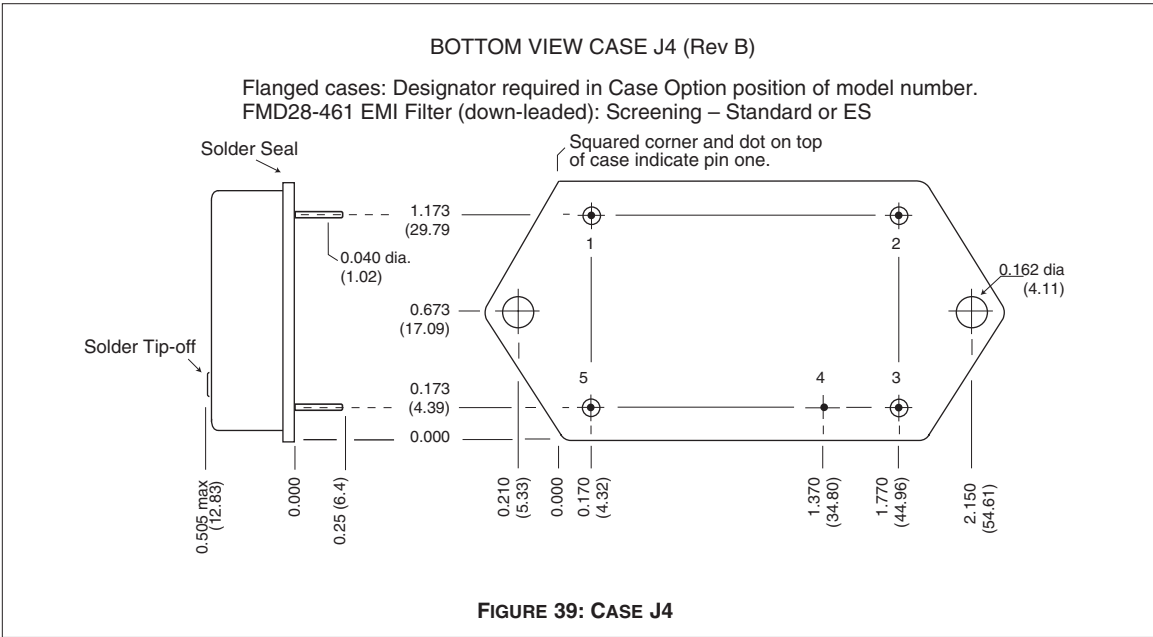

**QA SCREENING
125°C PRODUCTS**

125°C PRODUCTS

TEST (125°C Products)	STANDARD	/ES	/883 (Class H)*
PRE-CAP INSPECTION Method 2017, 2032	yes	yes	yes
TEMPERATURE CYCLE (10 times) Method 1010, Cond. C, -65°C to 150°C Method 1010, Cond. B, -55°C to 125°C	no no	no yes	yes no
CONSTANT ACCELERATION Method 2001, 3000 g Method 2001, 500 g	no no	no yes	yes no
BURN-IN Method 1015, 160 hours at 125°C 96 hours at 125°C case (typical)	no no	no yes	yes no
FINAL ELECTRICAL TEST MIL-PRF-38534, Group A Subgroups 1 through 6: -55°C, +25°C, +125°C Subgroups 1 and 4: +25°C case	no yes	no yes	yes no
HERMETICITY TESTING Fine Leak, Method 1014, Cond. A Gross Leak, Method 1014, Cond. C Gross Leak, Dip (1 x 10 ⁻³)	no no yes	yes yes no	yes yes no
FINAL VISUAL INSPECTION Method 2009	yes	yes	yes

Test methods are referenced to MIL-STD-883 as determined by MIL-PRF-38534.

*883 products are built with element evaluated components and are 100% tested and guaranteed over the full military temperature range of -55°C to +125°C.

Applies to the following products

MOR Series	MHD Series	MGH Series	FMGA EMI Filter
MFLHP Series	MHV Series	MCH Series	FMSA EMI Filter
MFL Series	MHF+ Series	FM-704A EMI Filter	HUM Modules**
MHP Series	MHF Series**	FMD**/FME EMI Filter	LCM Modules**
MTR Series	MGA Series	FMC EMI Filter	LIM Modules
MQO Series**	MSA Series	FMH EMI Filter	

**MFLHP Series, MQO Series, MHF Series, FMD EMI Filters, Hum Modules, and LCM Modules do not offer '883' screening.